



SECTION 04

PARTS FOR VIDEO CASSETTE REPAIR



04

SECTION CONTENTS

→ Video Heads	2
→ Video Heads - Cross Ref	6
→ Video Belt Kit - Cross Ref	8
→ Video Belt Kits	10
→ Video Belts	11
→ Video Idler Tires	12
→ Video Pinch Rollers	13
→ Video Overhaul Kits	18
→ Video Sensors	21
→ Brake Pads	22
→ Servicing Tools	22
→ Servicing Accessories	23

NOTE: YOU ARE VIEWING AN ABRIDGED VERSION

MORE VCR PARTS ARE AVAILABLE:

There is an extensive range with thousands of Video Parts stocked. These are not listed here in this print due to space restrictions. For a complete listing, please refer to previous WES Catalogues or download the updated PDF catalogue (with ex GST pricing) here: www.wescomponents.com/vcr/

WES VIDEO PARTS CATALOGUE

The full 100 page Video Parts Catalogue is available on request. For your free copy of this catalogue please order a WES-SEC04.

Code	Cost
WES-SEC04	Free



04 VCR COMPONENTS

→ Video Heads

GRADE "A" VIDEO HEADS [PAGE 1/3]

All VCR Heads are of OEM quality. Please be careful when replacing the heads, as physically damaged items are not covered under warranty. For a head not listed here, please enquire as there may be more substitute options available. VH=Upper Drum Only VHD=Upper & Lower Drum with Motor

PLEASE REFER TO CROSS-REFERENCE LISTING [PAGE 6] FOR SUGGESTED MODELS

Replaces	Equiv.	Code
AMSTRAD 255015, FUNAI,TEAC 8059-08-05 [SP/LP]		VH146
AKAI BV-V1004A280A	BV-V1022A170A	VH50
AKAI BV-V1030A220D		VH55
AKAI BV-V1047A220A		VH56
AKAI BV-V1015A120A		VH57
AKAI BV-V1075A420G	BV-V1123A420A	VH58
AKAI BV-V1075A420B	BV-V1102A420E, V1123A420B	VH59
AKAI BV-V1039A120A		VH270
AKAI BV-V1102A420G	BV-V1102A420C, V1102A420D	VH285
AKAI BV-V1102A420D		VH286
AKAI BV-V1182A420B		VH288
AKAI BV-V1182A420E		VH289
AKAI BV-V1123A420C	CIRCUIT BOARD TYPE	VH290
AKAI BV-V1182D420A	CIRCUIT BOARD TYPE	VH291
AKAI BV-V1234D430E	PIN TYPE	VH293
DAE-WOO, TEMPEST 97SA217900		VH190
DAE-WOO, TEMPEST 97SA428700		VH191
DAE-WOO, TEMPEST 97SA428700		VH193
FUNAI,TEAC 8000-01-13		VH140
FUNAI,TEAC 8059-01-19		VH142
FUNAI,TEAC 8059-01-20		VH143
FUNAI,TANDY 8059-01-95		VH144
FUNAI,TEAC 8059-08-05 [SP]		VH145
FUNAI,TEAC NFN513		VH147
FUNAI,TEAC 62DD806501601		VH440
FUNAI,TEAC 620806501610		VH442
GOLDSTAR 413-014/50/51/75/98		VH180
GOLDSTAR 413-159A		VH182
GOLDSTAR/NEC 413165D		VH185
HITACHI 5458161	5458165	VH94
HITACHI 5458413,5458415,5458282	5.45899E+14	VH96
HITACHI 5458104	5458282	VH98
HITACHI 5458434	5459002	VH99
HITACHI 5459001		VH100
HITACHI 5457474		VH240
HITACHI 5436103		VH245
HITACHI 5457471		VH248
HITACHI 5457472		VH249
JVC PU31332D	PU31332-GIO	VH10
JVC PU31332J		VH12
JVC PU31332L		VH14
JVC PQ20020B		VH15
JVC PQ20016B-2		VH16
JVC PQ20013C		VH17
JVC PU20850G		VH18
JVC PU31332F		VH20
JVC PDM2119		VH202
JVC PDM2001C-8		VH203
JVC PDM2004B		VH204
JVC PDM2007A		VH205
JVC PDM2112B		VH206
JVC PQ20014C/C4		VH207
JVC PDM3403C		VH210
JVC PRD2002D		VH214
JVC PDM2002C		VH215
JVC PDM2008C-5		VH216
JVC PDM2104B-9	PDM2104D	VH217
JVC PRD30050B		VH218
JVC PDM3353L		VH219
JVC PDM3353J14		VH420
JVC NKP0003LP	428869110625	VH425
MITSUBISHI 927B72302		VH119
MITSUBISHI 928B00804	928B00803	VH120
MITSUBISHI 928B22102		VH121
MITSUBISHI 928B334020		VH122
MITSUBISHI 927B499021		VH123

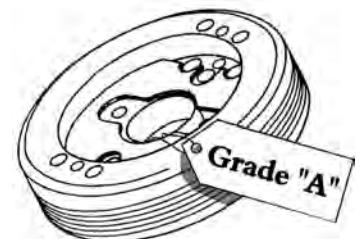



→ Video Heads

GRADE "A" VIDEO HEADS 2/3

Replaces	Substitutes	Code
mitsubishi 928B79909		VH124
mitsubishi 928B17302	928B173050	VH125
mitsubishi 928B09004		VH126
mitsubishi 928B64109		VH127
mitsubishi 928B65409		VH128
mitsubishi 928B29602		VH130
mitsubishi 928B32207		VH132
mitsubishi 928B984021		VH133
mitsubishi 927B723014		VH134
mitsubishi 928B20702		VH135
mitsubishi 928B40409		VH136
mitsubishi 948B07002		VH137
mitsubishi 928B37107		VH138
mitsubishi 927B730021	928B65413 928B65407	VH139
NATIONAL VEH0103	VEH0131	VH30
NATIONAL VEH0322		VH31
NATIONAL VEH0366		VH32
NATIONAL VEH0339		VH33
NATIONAL VEH0416	VEH0386	VH34
NATIONAL VEH0115		VH35
NATIONAL VEH0417	VEH0385	VH36
NATIONAL VEH0288	VEH0279	VH37
NATIONAL VEH0265	VEH0231	VH38
NATIONAL VEH0343		VH39
NATIONAL VEH0121	VEH0115	VH40
NATIONAL VEH0171		VH41
NATIONAL VEH0177		VH42
NATIONAL VEH0201		VH43
NATIONAL VEH0209		VH44
NATIONAL VEH0252		VH45
NATIONAL VEH0218		VH46
NATIONAL VEH0267	VEH0256	VH47
NATIONAL VEH0287	VEH0270	VH48
NATIONAL VEH0286	VEH0295, VEH0296	VH49
NATIONAL VEH0352		VH201
NATIONAL VEH0225		VH298
NATIONAL VEH0269		VH299
NATIONAL VEH0300		VH300
NATIONAL VEH0323	VEH0324	VH303
NATIONAL VEH0400		VH304
NATIONAL VEH0415		VH305
NATIONAL VEH0433		VH310
NATIONAL VEH0467		VH315
NATIONAL VEH0454		VH317
NATIONAL VEH0531		VH319
NATIONAL VEH0532		VH320
NATIONAL VEH0548		VH330
NATIONAL VEH0598		VH335
NATIONAL VEH0599		VH336
NATIONAL VEH0601		VH337
NATIONAL VEH0653		VH340
NATIONAL VEH0679		VH343
NATIONAL VEH0712		VH346
NEC 824 23AH1		VH160
NEC 824 34AH1		VH161
NEC 826 11AH1		VH163
NEC 826 91AH1		VH164
NEC 82B 26AH1		VH165
NEC 827 63AH1		VH166
NEC NNC601		VH168
NEC 79V15036		VH172
NEC 79V15879		VH173
NEC 79V15041		VH174
ORION VH1, VH2		VH150
ORION VH3		VH155
TOSHIBA 70321968		VH89
TOSHIBA 70321806	70321542	VH90
TOSHIBA 70321320		VH91
TOSHIBA 70321488		VH92
TOSHIBA 70321994	70321827	VH93
TOSHIBA 70325174		VH389
TOSHIBA 70325185		VH390

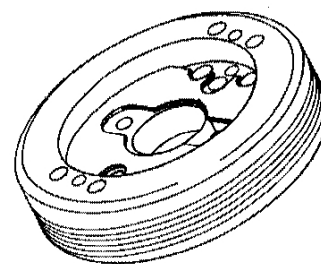
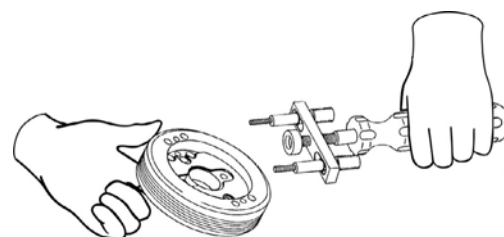
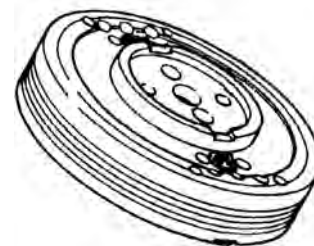



→ Video Heads

GRADE "A" VIDEO HEADS 3/3

Replaces	Substitutes	Code
SAMSUNG 69000-390-013 (Grade "A")		VH77
SAMSUNG 69000-342-400		VH75
SAMSUNG 69000-390-012		VH76
SAMSUNG 69000-390-026		VH375
SAMSUNG 69020-124-042 (Head Only!)		VH376
SAMSUNG 69000-390-271		VH78
SANYO 613-022-0264	613-078-8672	VH79
SANYO 143-0-242V-22300/22400	143-0-242v-01700/002200	VH80
SANYO 143-0-771T-06500	143-0-771T-06800	VH81
SANYO 143-0-771T-13400	143-0-771T-09000	VH82
SANYO 143-0-762T-02000		VH85
SANYO 143-0-771T-06100	FISHER	VH87
SANYO 143-0-771T-25221		VH88
SANYO 613-096-8039		VH171
SANYO 613-164-0719		VH179
SANYO 613-166-2926		VH371
SANYO 143-0771T-09200		VH209
SHARP DDRMU0002HE09		VH21
SHARP DDRMU0004HE09	DDRMU0004HE12	VH22
SHARP DDRMU0001HE10		VH23
SHARP DDRMU0002HE04 SHARP DDRMU0002HE05	DDRMU0002HE02	VH24
SHARP DDRMU0004HE14	DDRMU0004HE17	VH26
SHARP DDRMU0004HE04		VH27
SHARP DDRMU0002HE17		VH28
SHARP DDRMW0005HE02		VH220
SHARP DDRMU0005HE10		VH224
SHARP NSH515		VH322
SHARP NSH516		VH222
SHARP NSH853		VH323
SHARP DDRMU0002HE36		VH225
SHARP DDRMU0002HE39		VH226
SHARP DDRMU0004HE22	DDRMU004HE23 TV/VCR	VH228
SHARP NSH551		VH229
SHARP NSH513		VH230
SHARP NSH852	NSH552	VH321
SHARP NSH855		VH339
SONY DSR-36R		VH60
SONY DSR-21R		VH65
SONY DSR-35R		VH68
SONY DSR-43R		VH70
SONY 884-854-001		VH71
SONY DZR-27R 8848-54501		VH72
SONY 3-955-048-01		VH360
SONY 1-550-536-11		VH175
SONY 1-550-534-11		VH176
SONY 1-550-694-11		VH177
SONY 8-848-625-01		VH178

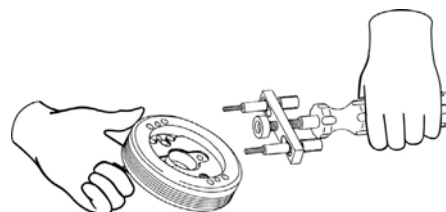

DRUM ASSEMBLIES COMPLETE

See Also Page 4-8...

Includes Upper-Drum (Video Head) with Lower-Drum & Motor

Description	Code
LG / AKAI DRUM ASSEMBLY 6723R-0101B	VHD0101
LG / AKAI DRUM ASSEMBLY 6723R-0103B	VHD0103
AKAI DRUM ASSEMBLY BV-V9009 A020A	DRM12
JVC DRUM ASSEMBLY HR-D170	DRM170
HITACHI DRUM ASSEMBLY VT128	DRM128
SAMSUNG DRUM 69017-123-710	DRM971
SAMSUNG DRUM 69017-124-042	DRM124
SAMSUNG DRUM 69017-124-059	DRM125
SAMSUNG DRUM 69017-124-061	DRM127

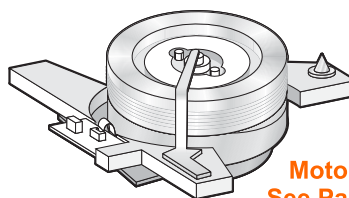

Motor Only
See Page 4-9

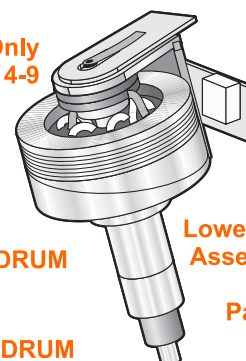

Lower Drum
Assemblies
See
Page 4-2

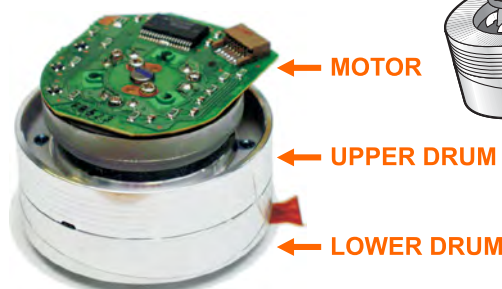

Upper/Lower Drum Assemblies

Please note that some of the latest heads are only available in this complete form.

If the Upper Drum is available separately, it will be listed as "VH" and share the same suffix number from the substitution list as the "VHD" code number. (But not "DRM").

This is because of new manufacturing and head alignment techniques.



→ Video Upper/Lower Drum Assemblies

AKAI / LG DRUM ASSEMBLIES

VHD Upper & Lower Drum assemblies With Motor.

6723R-0101B

Code VHD0101

6723R-0103B

Code VHD0103

Head only is available. See VH Listing.



UNIVERSAL HEAD EXTRACTOR TOOL

Hand tool designed for extracting video heads without damage to the drum assembly. Adjustable for various heads.

Code HT800

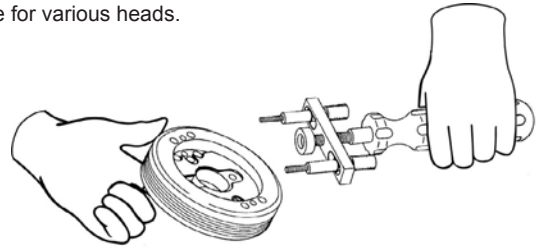

COTTON GLOVES

Eliminate the need to clean heads after fitting by using gloves. Recommended by leading manufacturers. Sold in pairs.

Code GLV2

FUNAI LOWER DRUM ASSEMBLY

NON-SOLDER TYPE

Original Part No 6004-09-01, Chassis V-3S

Models MV307, 316, 445, 450, VCR417, 9000, VGX815, 820, VR1900, VX4000

Suit VH142 / 143 (not inc.)

Code FU901

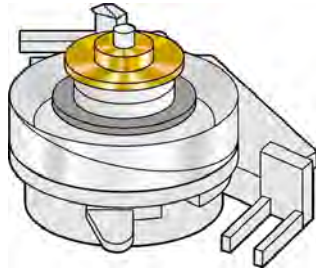

HITACHI DRUM ASSEMBLY

Complete UPPER & LOWER assembly. Suit VT128, etc.

Code DRM128

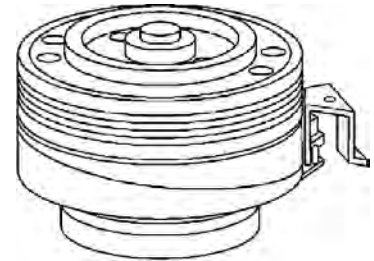

JVC COMPLETE DRUM ASSEMBLY

Upper and lower drum assembly with motor, etc. Suit HR-D170, 171, etc.

Code DRM170

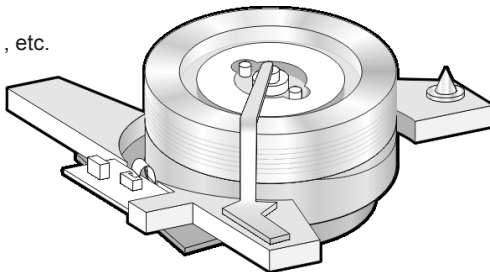

SAMSUNG LOWER DRUM ASSEMBLIES

69000-370-034 (2HEAD)

Suit Code PB970, 971, TE90H DRM970

69000-400-013 (4HEAD)

Suit Code VB350 LDR13

69000-291-083 (2HEAD)

Suit Code VB306 LDR83

69000-291-084 (4HEAD)

Suit Code VB336 LDR84

HEAD SOLD SEPARATELY

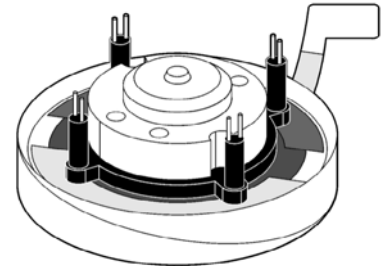

JVC LOWER DRUM ASSEMBLY

Lower drum & motor, etc. REQUIRES VIDEO HEAD

Suit Code HRD580 PDM2138H
HRDX20 PDM2138Y

VIDEO HEAD

Optional Upper Drum

Suit Code HRDX20 VH216

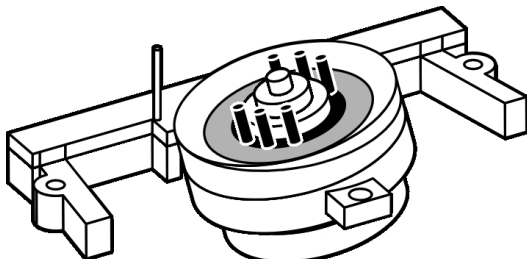

SAMSUNG DRUM ASSEMBLY

69017-123-710

Suit Code PB970, 971, 972 DRM971

69020-124-042

Suit Code SV30B, AV30BV DRM124

69020-124-059

Suit Code SV80, 81 DRM125

69020-124-061

Suit Code SV140 DRM127

INCLUDES VIDEO HEAD

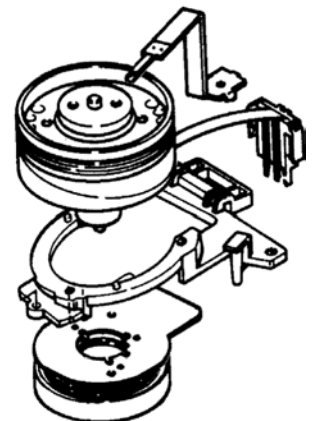



→ Video Heads - Cross Reference

Suit	Code	Suit	Code	Suit	Code	Suit	Code
Panasonic Cont'...				PALSONIC			
NV7500,7800	VH40	VCR5000	VH14	M10,11,20,21,NX10	VH80	KV14VMIAS	VH142
NV8400	VH30	VCR6000	VH14	VBS7500,7600	VH80	SL8000,8080	VH70
NV8600	VH35	VCR7000	VH180	VTC5000,5005,5300	VH80	SLC5E,6E,7E,8	VH60
NV8610,8620	VH40	VCR7000	VH182	VTC5350,5400,5500	VH80	SLC9,	VH65
NV-D38,48	VH39	BLAUPUNKT		VTC5550	VH85	SLC30,34,35,40	VH68
NV-D80	VH201	VR288,299	VH425	VTC6000	VH80	SLF1,F30	VH68
NV-FS1	VH305	VR357,388,399	VH425	VTC9100,9300	VH85	SLV353	VH176
NV-F55	VH330	VR453	VH420	VTC9355,9500	VH85	SLVX10,20,25	VH79
NV-F70	VH310	VR401,501,502	VH24	VHR120	VH79	SLVX35	VH72
NV-F96	VH330	VR601	VH21	VHR270	VH173	SLVX30	VH72
NV-FS90	VH315	VR701,901	VH24	VHR190,194,219	VH174	SLVX50	VH71
NV-FS100	VH317	VR6020	VH38	VHR390,774	VH174	SLVX90,95,700	VH172
NV-G7,9	VH49	VR6420	VH46	VHR610,630	VH179	SLVX800	VH360
NV-G10,11,12,16	VH48	VR6440	VH25	VHR1100	VH87	SLVX810	VH177
NV-G20,21,22	VH39	VR6348,6441,6442	VH28	VHR1300	VH88	SLVX811	VH178
NV-G30,40	VH34	VR6443,6448	VH28	VHR1500,2500	VH81	SLV757	VH175
NV-G33,45,46	VH36	VR6460	VH46	VHR2370	VH88	SVT5000	VH172
NV-G38	VH39	VR6490	VH36	VHR2700	VH209	TANDY	
NV-G50,500	VH304	VR6520	VH28	VHR3100,3200	VH82	VR1500	VH180
NV-G400	VH303	VR6540	VH25	VHR4100,5100	VH79	VR2000	VH142
NV-H65	VH33	VR6541,6542	VH25	VHR5300	VH171	VR2700	VH144
NV-H70	VH31	VR6543	VH22	VHR5810	VH173	VR3000	VH171
NV-H75	VH201	VR6548,6648	VH26	VHR7100,7200	VH79	TEAC	
NV-HD70,100	VH337	VR6640	VH25	VHR7400,7440	VH171	MV306,307	VH142
NV-J1,J3,J4	VH34	VR6641	VH28	TL5900	VH371	MV330	VH142
NV-J11	VH320	VR6711	VH45	SHARP			
NV-J30,J33	VH34	VR6740,6745	VH27	VC90ET	VH322	MV400,430,435	VH140
NV-J35	VH36	VR6741,6742	VH22	VC100,200	VH28	MV445,450	VH142
NV-J36	VH34	VR6840	VH21	VC110	VH25	MV606	VH147
NV-J45	VH319	VR6920	VH38	VC300,381,383,385	VH24	MV1400,1440	VH140
NV-J101	VH34	VR6940	VH220	VC384	VH25	MV1480	VH142
NV-L10,L15,L20	VH34	PIONEER		VC385,386,387,388	VH24	MV2020	VH140
NV-L25	VH36	VH780D	VH163	VC390X	VH21	MV3010,3050	VH440
NV-M7	VH32	USUALLY HITACHI		VC400	VH24	MV6010	VH442
NV-P10	VH34	PRESIDENT		VC481,482	VH25	TELEFUNKEN	
NV-SD1	VH340	PV300	VH155	VC483,486	VH27	VR440	VH40
NV-SD10	VH336	PYE		VC488	VH220	VR520	VH10
NV-SD20,25	VH335	65VR20	VH46	VC496	VH21	VR540	VH20
NV-SD200,220	VH346	VRD022	VH24	VC500,581,582	VH28	VR743	VH337
NV-SD250,270	VH346	VRD100	VH191/VH193	VC583,584	VH28	VR980	VH17
NV-SD400,420,450	VH343	VRD300L	VH191/VH193	VC585	VH22	VR1935	VH25
TC14SV10	VH343	VRD100L	VH75	VC6V3	VH28	VR2925	VH16
TC21SV10	VH343	VRS012,022	VH24	VC600,651	VH28	VR7979	VH205
NEC				RANK			
B5	VH70	PVC754E	VH60	RV225	VH14	TEMPEST	
DS6000A	VH165	RV225	VH14	RV300,310	VH10	TE77R	VH75
DX1600	VH160	RV320,330,340,350	VH14	RV360,370,375,380	VH14	TE99R	VH191/ VH193
DX3000	VH163	VP100	VH14	TE90H,900			
N830,831,832	VH14	SABA		TE970R	VH191/ VH193	TITAN	
N833,834,835	VH14	VR6005	VH20	VCR1500	VH12	TRACKTON	
N895	VH17	VR7000	VH10	VCR-32	VH191/ VH193	TRACKTON	
N901,904	VH160	VR7730	VH10	VCR-417TR	VH142	TRACKTON	
N911,912	VH161	SAMSUNG		VCR-417TR	VH142	TOSHIBA	
N9011,9013	VH160	PB/PK/PX990,1,2	VH78	V21,31,33,51,53			
N9033,9034,9040	VH160	PB30R,VB306	VH76	V55,V57	VH14	V63	
N9052,9053	VH160	VB300,350	VH77	V63	VH93	V71,73,75,	
N9063,9065,9066	VH160	VB336	VH77	V71,73,75,	VH89	V81,83,84,85,86,93A	
N9073,9077,9083	VH160	VB370	VH375	V300	VH89	V300	
N9280	VH166	VB617,627,629	VH75	V500	VH390	V5250	
N9401,9402	VH160	VB705,710,711,712	VH75	V5470	VH91	V5700	
N9530,9570	VH164	VB713,720,721,729	VH75	V8600	VH92	V7000	
N9610,9680	VH163	VB900,910,911,920	VH75	V8700	VH89	V9600	
PVC754E	VH60	VB930,950,970,971	VH75	VIDEO-PRO			
VH81	VH173	VB972,978,981,990	VH75	VCR8025 with PCB	VH190	VCR8025 PIN type	
VH90,91,92	VH174	VB/VX1230	VH76				
VN20,22,25	VH193	VB1260,1261	VH76				
VN23,26	VH168	VB/VK/VX1530	VH77				
VN30,31,32,35	VH79	VB/VK/VX1560,1561	VH77				
VN63	VH185	VB1850	VH375				
VN70,71,72	VH172	VD711,714	VH75				
NORDMENDE							
Similar to JVC							
V100,250,350,550	VH10	VX510,616	VH75				
V101,102,103,302	VH14	VX971,972	VH75				
V304	VH16	SV30BV	VH376				
V380	VH18	ORION					
V502	VH17	VH1,VH2,VH2B	VH150				
V1005,1015,1025	VH16	VH2B,VH3	VH155				
V1065	VH16	NOTE. ONE MODEL MAY USE VARIOUS CHASSIS.					
V3005,3105	VH209						
V3505	VH206						





→ VIDEO BELT KIT SUBSTITUTION LIST

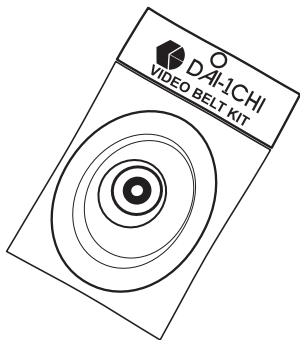
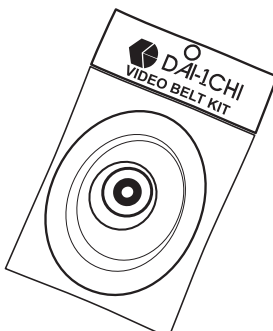
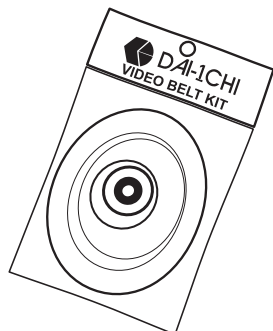
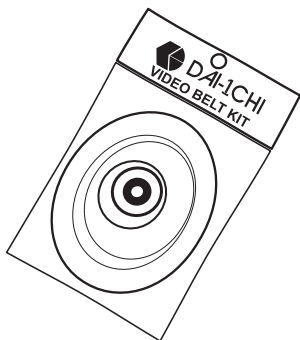

VIDEO BELT KIT SUBSTITUTION LIST

The following list has been compiled from information received from our customers and is offered as possible suggestions for usage. Please advise us if you find any errors or additions.

Thank you.

PLEASE NOTE THE PRICES OF THE KITS ARE ON THE PREVIOUS PAGE

Suit Code

AKAI

VP77	VBK74
VS1,2,5	VBK3
VS3,4,6,8	VBK55
VS10	VBK4
VS11,12	VBK97
VS15	VBK55
VS22,26,35	VBK91
VS53,55,75	VBK91
VS112,115	VBK71
VS155,165	VBK71
VS200	VBK93
VS240,515	VBK71
VS7100	VBK40
VS7300	VBK1
VS9300,9500	VBK34
VS9700	VBK2
VS9800	VBK34
VSP3	VBK81

AIWA

HV-G900BPG	VBK87
------------	-------

AMSTRAD

DD9904	VBK129
UF22	VBK120
VCR6000	VBK87

AWA/THORN

2H20D, 4H40D	VBK123
AV1,ATV1	VBK37
AV12,14	VBK76
AV47,49	VBK111
AV51,52	VBK76
AV58,59	VBK111
AV61	VBK80
AV62	VBK100
AV337	VBK111
AV400,410,	VBK76
AV411,412,421	VBK111
TR102	VBK76

BLAUPUNKT

RTC250,256,350	VBK131
RTV222	VBK. 8
RTV301	VBK49
RTV311,434	VBK50
RTV321	VBK48
RTV322	VBK43
RTV328	VBK52
RTV350,356,456	VBK131
RTV424,444	VBK46
RTV716,725,785	VBK131
RTX200	VBK11

CASIO

VX2000	VBK88
--------	-------

COMPUTAR

CTR3024	VBK118
---------	--------

Suit Code

DEITRON

DVR6158D	VBK103
----------	--------

DISTAR

DS757	VBK97
-------	-------

E.S.C.

VCR8025	VBK85
---------	-------

FUNAI

VCR4600,4800	VBK110
VCR5200,5400	VBK110
VCR5600,6600	VBK110
V P5000	VBK110

FISHER

FVH-P520	VBK82
FVH-P530	VBK96
FVH-P620	VBK94
FVH-P710,720	VBK94
VBS9000	VBK27

HITACHI

VT7E,8E	VBK67
VT11E,17E,19E,20E	VBK68
VT33E,35	VBK72
VT63E,88	VBK68
VT138	VBK108
VT168	VBK108
VT178E	VBK73
VT258	VBK68
VT330	VBK73
VT518	VBK51
VT640,660	VBK73
VT860	VBK73
VT3000	VBK42
VT5000	VBK. 5
VT6500,6800	VBK115
VT8000,8050	VBK44
VT8500	VBK65
VT9300	VBK66
VT9500	VBK114
VT-P30	VBK72

HMV

HV1000	VBK41
HV2000	VBK53
HV3000	VBK54
HV4000	VBK45
HV7000.	VBK4
HV8000	VBK36
PP24	VBK74

G A C

VB910	VBK81
-------	-------

G.E.

6900	VBK45
64007300	VBK64
8100	VBK64
8900	VBK36
9300	VBK64

GENERAL

VGX930A	VBK102
---------	--------

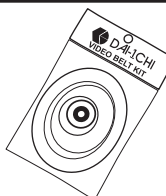

Suit Code

GOLDSTAR

GHV1232,1240,1246	VBK80
GHV1296	VBK102
VCP100,105,110,	VBK119
VCP120,126,	VBK119
VCP4100	VBK80

GENERAL

VG220A	VBK32
VGX510	VBK99
VGX540	VBK109
VGX625,645	VBK109
VGX715,720	VBK110
VGX815,820A	VBK87

JVC

CP5000E	VBK75
CR6000E,6060E	VBK75
HR2200	VBK74
HR2650	VBK45
HR3300,3600	VBK53
HR3330	VBK. 7
HR3360,3660	VBK54
HR4100	VBK20
HR7200	VBK45
HR7650,7655	VBK36
HR7600	VBK36
HR7700	VBK. 4
HR-D110,111	VBK64
HR-D120,125	VBK64
HR-D140,141,143	VBK78
HR-D150,152,156	VBK78
HR-D157,158,160	VBK78
HR-D170,171,180	VBK77
HR-D190	VBK78
HR-D220,225	VBK64
HR-D250,275	VBK78
HR-D320,370,430	VBK86
HR-D455	VBK78
HR-D520,521,522	VBK116
HR-D540,580	VBK124
HR-D565,566	VBK78
HR-D600,610,620	VBK116
HR-D725,755	VBK78
HR-D790	VBK125
HR-D830	VBK116
HR-DX20,22	VBK116
HR-J200,400	VBK116
HR-J220,221	VBK128
HR-J255,455	VBK133
HR-J600	VBK127
HR-J625,635	VBK128
HR-J655,755	VBK133

KAMBROOK

KVP120	VBK119
--------	--------

MARANTZ

MV740A	VBK61
See Sharp/Philips	

MASUDA

M22	VBK80
-----	-------

MITSUBISHI (SEE ALSO AWA)

HS337,338	VBK111
HS347,349	VBK111
HSE11,21,41	VBK118
HSM54,59	VBK118
HSMX1,X2	VBK118
HSMX7	VBK126

NORMENDE

VR200	VBK41
-------	-------



→ VIDEO BELT KIT SUBSTITUTION LIST

Suit	Code	Suit	Code	Suit	Code	Suit	Code
NATIONAL/PANASONIC				PIONEER			
NV-M1,M3	VBK51	VH-780D	VBK83	SANYO			
NV250,280	VBK50	PANASONIC				TEAC	
NV300,333,340	VBK12	<i>SEE NATIONAL</i>				MV306,307,308,330P	VBK87
NV370	VBK49	PHILIPS				MV314,315	VBK120
NV450,470	VBK50	VR107,110	VBK132	VHR120	VBK105	MV3410,4810	VBK120
NV600	VBK48	VR155,255,455	VBK128	VHR1500	VBK89	MV400,430	VBK88
NV730,770	VBK52	VR210,275,299	VBK132	VHR2500	VBK104	MV435,440	VBK88
NV750	VBK47	VR256	VBK128	VHR2700	VBK92	MV445,450,616	VBK87
NV777,788	VBK43	VR257,357,357,399	VBK132	VHR3100,3500	VBK90	MV7,77,777	VBK131
NV850	VBK46	VR401,501,502	VBK39	VHR3700	VBK90	MV1400,1414TV	VBK88
NV870	VBK50	VR456,656	VBK128	VHR4100,5100	VBK105	MV1480	VBK87
NV2000,3000	VBK11	VR457,499,610,620	VBK132	VHR5300,5700	VBK105	MV2020TV	VBK88
NV7000	VBK10	VR555,655,755	VBK128	VHR7100,7200	VBK105		
NV7200,7500	VBK8	VR601,701,901	VBK39	VHR7500,7900	VBK105		
NV8170	VBK95	VR656	VBK128	VHR-D500,D700	VBK90		
NV8400	VBK35	VR757,799,810	VBK132	VHR-D4400,4600	VBK105		
NV8600,8610,8620	VBK9	VR820,857,899	VBK132	VHR-D4800,4890	VBK105		
NV-G7,9,10,11,12	VBK79	VR856	VBK128	VHR-D5810	VBK105		
NV-G16,30	VBK79	VR3360	VBK102	VHR-S-700	VBK106		
NV-H70A	VBK79	VR3442	VBK116	M10,M20N,M50,NX10	VBK59		
				VR457,499,610,620	VBK132		
				VR555,655,755	VBK128		
				VR601,701,901	VBK39		
				VR656	VBK128		
				VR757,799,810	VBK132		
				VR820,857,899	VBK132		
				VR856	VBK128		
				VR3360	VBK102		
				VR3442	VBK116		
				VR6440,6540	VBK61		
				VR6441	VBK62		
				VR6442,6443	VBK69		
				VR6448,6475	VBK102		
				VR6520	VBK69		
				VR6540	VBK61		
				VR6542,6543	VBK69		
				VR6548,6549	VBK102		
				VR6743	VBK69		
				VR6541,6575,6937	VBK62		
				VR6640,6740,6940,6840	VBK61		
				VR9489	VBK131		
				PRESIDENT			
				PV300,500	VBK117		
				PYE			
				VRS012,022	VBK39		
				VRD100	VBK107		
				VRD300	VBK103		
				RANK			
				RV300	VBK41		
				RV310	VBK7		
				RV320	VBK54		
				RV330	VBK4		
				RV340	VBK45		
				RV350	VBK36		
				RV360,370,380	VBK64		
				VP100	VBK74		
				SAMSUNG			
				VB617,617C	VBK98		
				VB627,629	VBK98		
				VB711	VBK97		
				VB711A	VBK107		
				VB750	VBK107		
				VB900A,910	VBK81		
				VB970,971,972	VBK97		
				VB2215P	VBK81		
				VB8220	VBK107		
				PB981R	VBK107		
				SHARP			
				VCA10,30,35	VBK102		
				VCA45,60	VBK102		
				VCA101,103	VBK69		
				VCA105,111,115	VBK102		
				VCA125,505,615	VBK102		
				VCA502	VBK69		
				VCA850	VBK102		
				VCD801,855	VBK69		
				VC200	VBK69		
				VC220N	VBK26		
				VC381,383,386	VBK39		
				VC387	VBK24		
				VC388,390	VBK39		
				VC481,482,483	VBK61		
				VC486,488	VBK61		
				VC500	VBK69		
				VC581,582	VBK62		
				VC583,584,585	VBK62		
				VC6V3,6F3	VBK69		
				VC651,652,682,685	VBK69		
				VC700,779,793,781	VBK69		
				VC782,785,787	VBK69		
				VC2300K	VBK23		
				VC3300	VBK25		
				VC6000	VBK19		
				VC6300,6500	VBK18		
				VC7000,7100,7300	VBK17		
				VC7500	VBK19		
				VC7650	VBK30		
				VC7700,7750,7800	VBK17		
				VC8000,8110,8300	VBK56		
				VC8482	VBK61		
				VC9100,9300,9700	VBK39		
				VCH851X	VBK69		
				VCT310,510	VBK102		
				MANY LATE MODELS	VBK102		
				VCA,VCH,etc	VBK102		
				SONY			
				MHCU800	VBK134		
				SLC5E	VBK14		
				SLC6E	VBK28		
				SLC7E, SLT7E	VBK14		
				SLT9ME	VBK22		
				SL5400,5600,5800	VBK31		
				SL8000,8080	VBK13		
				SL8500	VBK13		
				SLVX10PS,20PS	VBK105		
				SLVX25PS	VBK105		
				SLVX37,X57	VBK122		
				TANDY			
				2B	VBK84		
				NEC			
Code	VDV0169						
Cost	3 05						
				ORION			
Some units may have different mech's for the same model No. The following is a general guide for the most likely "VBK" to suit.							
NATIONAL MECH. TYPES eg.							
VH2A MK11	VBK11						
SHARP MECH. TYPES eg.							
VH3C, VN2B	VBK39						
ORION MECH. TYPES eg.							
2B	VBK84						
RVP-114	VBK121						
VC10P	VBK117						
VCP	VBK117						
VCRLS,VDLJ,VLBK	VBK130						
PALSONIC							
VCR5000	VBK99						
VCR6000	VBK88						
VCR7000	VBK100						
VCR8000	VBK102						
VCR9000	VBK87						
VCR9500	VBK122						

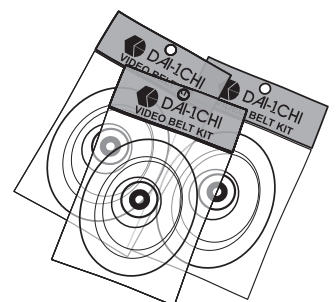



04 VCR COMPONENTS

→ Video Belt Kits

VIDEO BELT KITS

Code number and cost listing. Primary models listed only, due to space. For other models, see Cross-Reference Pages.

Suit	Code
AKAI VS7300	VBK1
AKAI VS9700	VBK2
AKAI VS2E/VS5E	VBK3
AKAI VS10, JVC HR7700	VBK4
HITACHI VT5000E	VBK5
SANYO 9300/9500	VBK6
JVC HR3330	VBK7
NATIONAL NV7200EN	VBK8
NATIONAL NV8600/NV8620	VBK9
NATIONAL NV7000	VBK10
NATIONAL NV2000	VBK11
NATIONAL NV300/NV340	VBK12
SONY SL8000/SL8080	VBK13
SONY C5E/C7E/T7E/T9E	VBK14
TOSHIBA V5250/V5280	VBK15
TOSHIBA V8600	VBK16
SHARP VC7300	VBK17
SHARP VC6300	VBK18
SHARP VC6000	VBK19
JVC HR4100	VBK20
TOSHIBA V31/V33	VBK21
SONY SLT9ME	VBK22
SHARP VC2300K	VBK23
SHARP VC387	VBK24
SHARP VC3300	VBK25
SHARP VC220N	VBK26
SANYO VTC5500	VBK27
SONY SLC6E	VBK28
TOSHIBA V5470/V7540	VBK29
SHARP 7650	VBK30
SONY SL5400/SL5600	VBK31
TOSHIBA V5310C/V5310T	VBK33
AKAI 9300/9500/9800	VBK34
NATIONAL NV8400	VBK35
RANK RV350, HMV8000	VBK36
AWA ATVI ATI	VBK37
SHARP 300 & 9000 SERIES	VBK39
AKAI VS7100	VBK40
HMV1000-RANK RV300	VBK41
HITACHI 3000	VBK42
NATIONAL NV777	VBK43
HITACHI 8000/8050	VBK44
JVC HR2650/HR7200	VBK45
NATIONAL NV850	VBK46
NATIONAL NV750	VBK47
NATIONAL NV600	VBK48
NATIONAL NV370	VBK49
NATIONAL NV470	VBK50
NATIONAL NV-M1	VBK51
NATIONAL NV730/770	VBK52
JVC HR3300	VBK53
JVC HR3660	VBK54
AKAI VS3/VS4	VBK55
SHARP VC8300	VBK56
SANYO VTC5300	VBK57
SANYO VTC5000	VBK58
SANYO M10/M20/NX10	VBK59
SANYO VTC6500	VBK60
SHARP VC400 SERIES	VBK61
SHARP VC581, 582, 583 etc	VBK62
NEC PVC754E	VBK63
JVC HR-D110/D120/D225	VBK64
HITACHI VT8500	VBK65
HITACHI VT 9300	VBK66
HITACHI VT7E, VT8E	VBK67
HITACHI VT19E/20E/63E/88	VBK68
SHARP 600 & 700 SERIES	VBK69
NEC 901A, 911A	VBK70
AKAI VS112, 115	VBK71
HITACHI VT33E	VBK72
HITACHI VT640, 660, 860	VBK73
JVC 2200, AKAI VP77	VBK74

Suit	Code
JVC CR 5000E, 6000E, 6060E	VBK75
AWA AV12, AV14	VBK76
JVC HRD170, 370	VBK77
JVC HRD140 etc	VBK78
NATIONAL NVG7, 9, 16	VBK79
GOLDSTAR VARIOUS	VBK80
AKAI/SAMSUNG/TEMPEST 900	VBK81
FISHER FVH-520	VBK82
NEC N9530A	VBK83
ORION VH2B	VBK84
SAMSUNG and equivalents	VBK85
JVC HR-D430EA	VBK86
TEAC MV330P, 450, 445	VBK87
TEAC MV400, 430, 435 etc	VBK88
SANYO VHR-1300	VBK89
SANYO VHR-3100	VBK90
AKAI VS22	VBK91
SANYO VHR-2700	VBK92
AKAI VS200	VBK93
FISHER FVHP620, 710, 720	VBK94
NATIONAL NV8170	VBK95
FISHER FVH-P530	VBK96
TEMPEST TE90H	VBK97
SAMSUNG VB617, etc	VBK98
PALSONIC VCR5000	VBK99
PALSONIC VCR7000	VBK100
TOSHIBA V71, 73 etc	VBK101
SHARP VC-A105	VBK102
TEMPEST TE99R	VBK103
SANYO VHR-2500	VBK104
SANYO VHR-4100	VBK105
SANYO VHR-S700	VBK106
TEMPEST TE77R, PB980R	VBK107
HITACHI VT138	VBK108
GENERAL VGX540/625/645	VBK109
GENERAL, FUNAI	VBK110
AWA, MITSUBISHI	VBK111
TOSHIBA V93	VBK112
TOSHIBA V500	VBK113
HITACHI VT9500	VBK114
HITACHI VT6500, 6800	VBK115
JVC HRD520, 522, 600	VBK116
PRESIDENT PV300, PV500	VBK117
MITSUBISHI HSE11, MX1, 2	VBK118
GOLDSTAR KAMBROOK	VBK119
TEAC MV314, 315	VBK120
ORION RVP-114	VBK121
SONY SLVX37	VBK122
NEC VN23, 26, 64 & AWA	VBK123
JVC HRD540 / 580	VBK124
JVC HRD790	VBK125
MITSUBISHI HSMX7	VBK126
JVC HRJ600	VBK127
JVC HRJ220, 221, 625	VBK128
AMSTRAD DD9904	VBK129
ORION VCRLS, VDLJ, VLBK	VBK130
PHILIPS VR9489-39	VBK131
PHILIPS VR155 TO VR755	VBK132
JVC LP30005-003, -005	VBK133
SONY MHCU-800	VBK134

10 KITS ASSORTED LESS 10%
 50 KITS ASSORTED LESS 20%
 100 KITS ASSORTED LESS 25%

MOST VCR USE ONLY ONE BELT?
 If only one belt! See following pages.

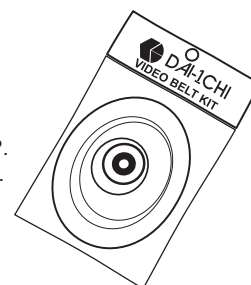



→ Video Belts

AKAI

Original Part No	Suit	Size	Code
	VS1,2,3,4,5,8	77x1.8mm	BLT7800
MB387289J	VS12,F10		BLT3872
MB364011	VS112,115, VS165,etc.		BLT4011
MB420053N	VSG mech.		BLT4200
BM433627N	VSG Mech	72x2x2mm	BLT3627

JVC

Original Part No	Suit	Equiv.	Code
	HRD170,180,370,400, HRD530, HRS5000, 5500.		PQM30003-19
	HRD160,200,230, HRD400,530, S5000, etc.		PQM30003-20
PU48941-2	HR7200,etc.	PU50350	BLT4894
	HR-D540, 580.		PU61006

NEC/DAEWOO

CAPSTAN BELT

Original Part No	79TD 3675
Suit	NEC VN23, VN26, AWA 2H20D,4H40D, and others.
Code	BLT3675

LOADING BELT

Original Part No	97S5500100, 79TD4460
Suit	VN23,26, AWA 2H20D,4H40D,
Code	BLT4460

LOADING BELT

Original Part No	16629251
Suit	N901,904,911,etc
Code	BLT9251

REEL BELT

Original Part No	97S5501800
Suit	VN20
Code	BLT1800

REEL BELT

Original Part No	97S 550 2300, 79TD 3940
Suit	VN22, VN25, NEC, AWA, and others.
Code	BLT3940

REEL BELT

Original Part No	97S 550 0400
Suit	D284G, D884G, DVK10W, 224D, DVK424D, 824D4, MV3080, 6080.
Code	BLT5500

PANASONIC/NATIONAL

Code	VDV0074
	VDV0122
	VDV0135
	VDV0138
	VDV0148
	VDV0149
	VDV0151
	VDV0152
	VDV0153
	VDV0169
	VDV0235
	VDV0382



SANYO

TYRE ONLY, to fit flywheel capstan.

Suit	VTC9300, 9500., 143-0-521T-01502
Code	FC T9300

REEL BELT

Original Part No	Code
VTC5000,5005,6500, M10,M20,NX10, 143-2- 564T-03200	BLT3200
VHR510,530,590, VHR610,630,650., 613- 151-9039	BLT9039

MITSUBISHI

Suit	AWA ATV10,AV11, THORN TR101
Original Part No	521D03301
Code	BLT3301

LOAD BELT

HS621,640,7424.	
Original Part No	Code
521D09601	BLT9601

REEL BELT

Original Part No	Code
521D097010	BLT9701

LG GOLDSTAR

Original Part No	4400R0005A
Suit	AF293, 493, 993, AC250, 450, 950, VSJ200, 215, 411, VSJ700, 711, 716,
Code	BLT0005

PANASONIC GEAR KIT

Kit combines VXP0767 VDV0159 and washers.

Code	VXP0917K
------	----------

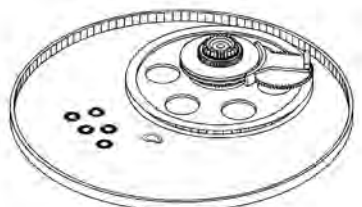

SAMSUNG

Original Part No	Suit	Code
65274-603-210	VB1230, etc. PB991, etc. VX & VR,...	VDV0149
65274-603-910	VB300, 306, 320, 336	BLT4603
61794-0009-00	SV10, 11, 12, 30, 80, 140	BLT6009

SHARP

CAMCORDER BELT

Original Part No	NBLTK0054GEOO
Code	BLT0054

MAIN BELT

Original Part No	NBLTK0067AJ00
Suit	VCA220, 270, 420, 470
Code	BLT0067

REEL BELT

Suit	VCA36,37,41,50,53,62, VCA67,93,94,97,98,...
Code	BLT0065

SONY

SYNCHRO BELT

Original Part No	Suit	Code
3-679-119-11	SLC30,32,33, SLC34,35,40.	BLT1911
3-977-510-01	SLVKH7,9	BLT1001

TOOTHED BELT

Original Part No	Suit	Code
3-736-013-01	SLV215,353,757, SLVX30,35,50, SLVX810,etc.	BLT1301
3-958-361-01	SLVX812, 822.	BLT6101

TEAC PALSONIC

Original Part No	62D80650920
Suit	MV3010, 3030, 3050, MV4010, 6010, Palsonic VCR9688
Code	69X2

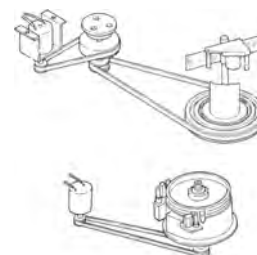



→ Video Idler Tyres

VIDEO TYRES & BELTS

Part numbers quoted are original manufacturers' part numbers for the complete assembly. Tyres only are supplied. When ordering please quote our VIT number only or you may receive the whole assembly! Many units are identical internally so you may find these tyres will substitute with other part numbers, other brands, etc.

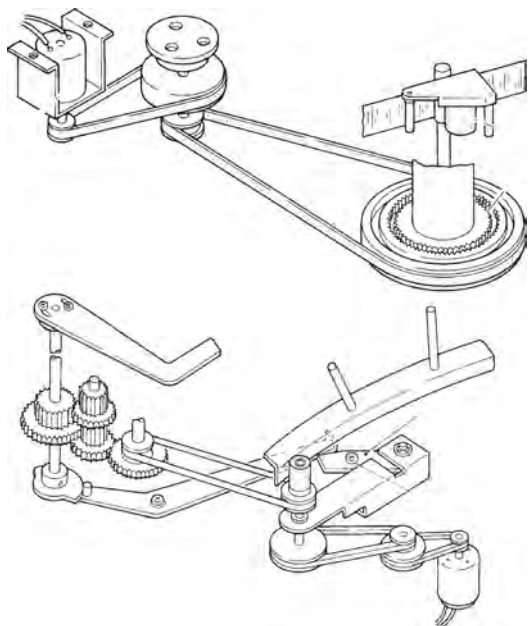

AKAI TYRES

Original Part No	Code
BV321761 TYRE	VIT12
BV321762 TYRE	VIT16
BV321979 TYRE	VIT20
BV327815L T/UP IDLER	VIT24
BV327815S T/UP IDLER.	VIT28
MI327773 FF/REW IDLER	VIT32
PU42164 TYRE	VIT34
PU42165-2 T/UP IDLER	VIT35
BL-B353110 TYRE	VIT455
PU44917 TYRE	VIT36
PU44918-2 REW IDLER	VIT40
PU46381 UNLOAD ASS	VIT44
PU48907A T/UP DISK	VIT48
PU48907B SUPPLY DISK	VIT52
PU48967A REEL IDLER	VIT56
MZ364046J1 TYRE	VIT60
65153600011 IDLER TYRE	VIT90

HITACHI TYRES

Original Part No	Code
6866971 TYRE	VIT80
6412654 TYRE	VIT84
6413114 TYRE	VIT88
6413144 TYRE	VIT92
6413202 TYRE	VIT96
6413633 TYRE	VIT100
6414221 TYRE	VIT104
6861471 TYRE	VIT108
6861482 TYRE	VIT112
6861505 TYRE	VIT116
6875386 TYRE	VIT120
6875371 TYRE	VIT124

JVC TYRES

Original Part No	Code
PU44918 T/UP DISK	VIT200
PU44918-4 F/F IDLER	VIT204
PU48811D, PU48806 IDLER.	VIT206
PU48907C T/UP DISK	VIT208
PU48907D SUPPLY DISK	VIT212
PU48907E T/U DISK	VIT214
PU48967B REEL IDLER	VIT216
PU49281 REWIND IDLER	VIT220
PU49283 PLAY IDLER.	VIT224
PU51402A T/UP IDLER	VIT228
PU55373 T/UP CLUTCH.	VIT232
PU55374-3-8 REEL TYRE	VIT236
PU58645-1-4 TYRE	VIT240

MITSUBISHI

Original Part No	Code
521D097010 REEL	BLT9701
521D96010 LOAD.	BLT9601

NEC

Original Part No	Code
16172931 IDLER	VIT450
16178173 25.5x30.5x3.5	VIT454
16178173 26.5x33x3.5	VIT455

PANASONIC TYRES

Original Part No	Code
VXA1491 FF/REW IDLER	VIT280
VXP0242 REWIND IDLER	VIT300
VXP0243, VXP0599 IDLER	VIT304
VXP0245 F/F IDLER	VIT308
VXP0292 REWIND IDLER	VIT312
VXP0329 FF/REW IDLER	VIT316
VXP0331 PLAY IDLER.	VIT320
VXP0343 PLAY IDLER.	VIT324
VXP0344 FF/REW IDLER	VIT328
VXP0401 FF/REW IDLER	VIT332
VXP0433 PLAY IDLER.	VIT336
VXP0463 FF/REW IDLER	VIT340
VXP0488 PLAY IDLER.	VIT344
VXP0515 FF/REW IDLER	VIT348
VXP0521 IDLER 24X30X3	VIT352
VXP0521 IDLER 23X30X3	VIT353
VXP0581 FF/REW IDLER	VIT356
VXL0404 IDLER UNIT	VIT380
VXL-0997 MOTOR TYRE	VIT390
MOTOR SLV NV730,777,788	VIT400

SANYO TYRES

Original Part No	Code
143-0-551T-01400 REW IDLR	VIT500
143-0-547T-00200 FF IDLR	VIT502
143-0-551T-01600 REW IDLR	VIT504
143-0-661T-03800 LOAD RLR	VIT508
143-0-662T 01201 REEL DR Also known as 143-0-741T-20001	VIT512
143-0-741T-11101 FWD RLR	VIT516
143-0-4104-0010 TYRE	VIT520
143-0-4104-0020 TYRE	VIT530

SHARP TYRES

Original Part No	Code
NDAIV1007GEZZ SPINDLE	VIT604
NIDL0005GEZZ IDLER	VIT608
NIDL0006GEZZ IDLER.	VIT612
MLEVF0027GEZZ F/F IDLER	VIT614
NIDR-0004GEZZ REW IDLER	VIT616
NBLTK0054GEOO Camcorder	BLT0054
NPLYV0014GEZZ IDLER BLOCK	VIT620
NPLYV0041GEZZ PULLEY	VIT624
NPLYV0051GEZZ PULLEY	VIT628
NPLYV0107GEZZ PULLEY and NPLYV0111GEZZ PULLEY	VIT632

SONY

Original Part No	Code
X-3653-310-0	VIT700
X-3653-315-0	VIT704
X-3659-324-0	VIT708
X-3671-053-0	VIT712
X-3671-015-0	VIT716
A-6706-348B	VIT720

SAMSUNG-TEMPEST

Original Part No	Code
65153600011/100 IDLER	VIT90
5253-701-1105 IDLER	VIT750

TOSHIBA

Original Part No	Code
70316057	VIT804
70353048 PAUSE LEVER TYRE	VIT808

AWA-THORN

Original Part No	Code
641B10101/2 IDLER	VIT65
522P002101 IDLER	VIT70



↓ Video Pinch Rollers

PINCH ROLLER ASSEMBLIES

All assemblies include rollers. For rollers only see previous pages.

For lifters and cams see following pages...

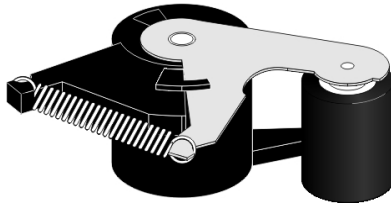

AKAI PINCH ROLLERS FROM VS SERIES

The original pinch roller used in some VS series Akai VCR's was a one piece type. The roller only for this assembly is VPR67. The one piece assembly has been upgraded and if a complete assembly is ordered then a new TWO piece type (VPR150) will be supplied. The roller only for VPR150 is a VPR69. We recommend using VPR150 for reliable service.



OLD TYPE

AKAI ROLLER ASSEMBLY

Original Part No	BL-387501J1
Equiv.	BL-V1075A180D
Suit	VS22,26,35,55,66,75,77,VS422,425,465,725, VSA650,VSF10,11,220,221,400,410,V SF422,425,430,600
Code	VPR150

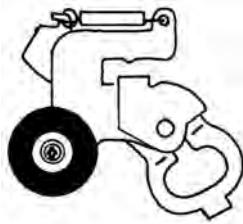

AKAI PINCH ROLLER

Original Part No	BL433609N3, N4
Suit	VSG280, VSG2DPL, VSG765, VSG790, VSG875.
Code	VPR156

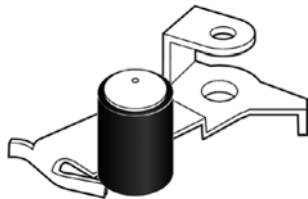

DAEWOO

Original Part No	97SB381800, 79TD3701
Suit	VN22,25, NEC, AWA, etc
Code	VPR185

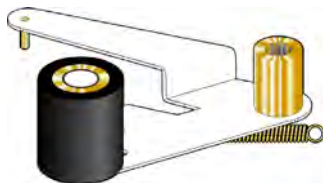

DAEWOO

Original Part No	97SA310700
Suit	D284G, etc.,
Code	VPR187



FUNAI/TEAC

Original Part No	8059-06-301
Suit	VCR417 & More...
Code	VPR180

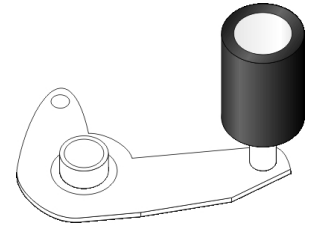

GOLDSTAR

Original Part No	333-209
Code	VPR170

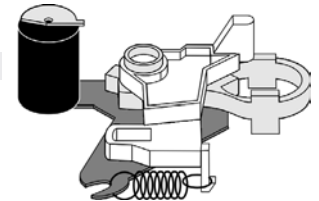

GOLDSTAR / NEC PINCH ROLLER

Original Part No	340-070A, 340-073A, 340-195A, 386-401A, 4930-0138A, NEC 79VG1020
Suit	W903H, VN36, P23H, etc.
Code	VPR171

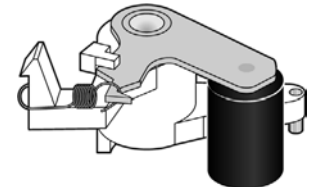

GOLDSTAR LG PINCH ROLLER

Original Part No	4261R0011A
Suit	AC250, 450, 950, AF293, 493, 993, Akai VSJ200, 215, 411, VSJ416, 700, 711, VSJ716, etc...
Code	VPR230



HITACHI PINCH ROLLER

Original Part No	6975768, 6384352
Suit	VTM598E, VTM838E
Code	VPR220

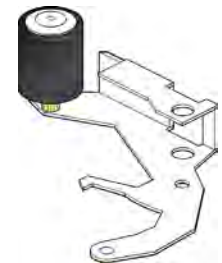

JVC

Original Part No	PQ43558
Suit	HRD520, 640, 830, HRDS5000, HRDX20EA, Philips VR3241, VR3275
Code	VPR143



Lifter to suit
PQ32415

Lifter Separate
PQ32415 →



→ Video Pinch Rollers

JVC

Original Part No PQ42006B
 Suit HRD170, etc. HRD200, 210, HRS5000, HRS5500, HRS9000
 Code VPR141

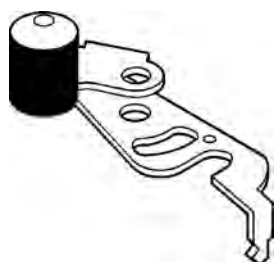

MITSUBISHI PINCH ROLLER

Original Part No 948D044001
 Suit HSM50, X3, HSMX5, X7, HSMX10, 20.
 Code VPR175



JVC PINCH ROLLER

Original Part No PQ45921E, PQ45921A6
 Suit HRJ600
 Code VPR139



NEC

Suit VN26, 26 NEC 79TD3683 97SA300600
 Code VPR186

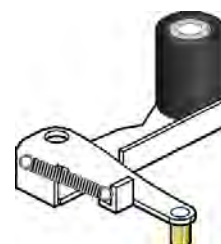

JVC

Original Part No PQ40134B
 Suit HRD110, 120, HRD121, 225, NEC N531, 830, 833 GR8100, 9300, and others.
 Code VPR140

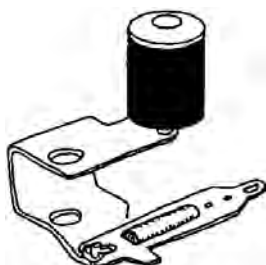

NATIONAL NV-M

Original Part No VXL1674 VXL1772
 Suit NV-MC10 NV-MC30, MS50
 Code VPR118 VPR136

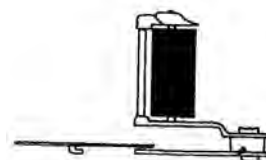

JVC PINCH ROLLER ARM

Original Part No JVC PQ46327A-2 Philips 482252811051
 Suit HRJ425, 435, HRJ625, etc. Philips VR656-75, VR555-75
 Code VPR142

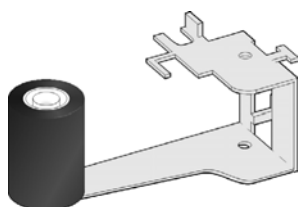

NATIONAL

VXL1858 or VXL1743
 NV-G20, 21, 22, 25, NV-G28, 40, 45, ...
 NV-D38, D48, NV-H65, H75, RTV740, etc...
 Code VPR120

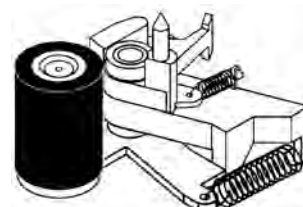

JVC / PHILIPS PINCH ROLLER

Original Part No LP40105-001A/B 4822-402-11057
 Suit HRJ255, 455, HRJ655, 755. VR288, 388.
 Code VPR165

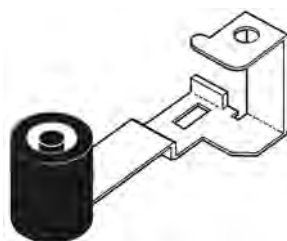

NATIONAL

Original Part No VXP0330
 Suit NV2000, 3000, Series
 Code VPR130



MITSUBISHI

Orig. 948D20010 or 789C007020
 Suit HSE11, 12, 21,
ORIGINAL

Code VPR160

REPLACEMENT

Code VPR161

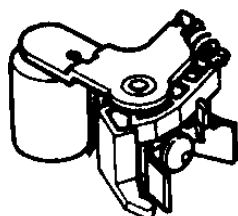

PANASONIC

Suit NVSD Mech.
 Code VXL2246

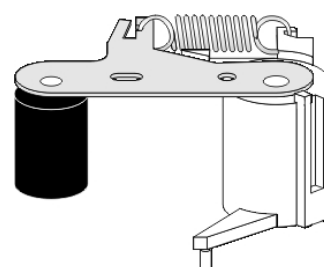



→ Video Pinch Rollers

PANASONIC PINCH ROLLER

Original Part No: VXL2676, VXL2785
 Suit: NVSD220, 270, 420, NVHD620, 670.
 Code: VXL2676

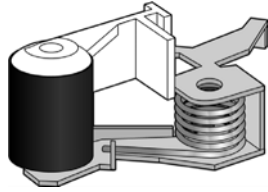

Roller Only

Code: VPR123

PHILIPS TEAC PINCH ROLLER - NEW!

Original Part No: 4822 528 70774, 8619 119 175
 Suit: MV7, 77, 777, RTV785, VR9489,
 Code: VPR274



(Two types used in one model - See below)

VPR124 - 2 TYPES 2.5mm & 3mm

3.0mm BEARING SHAFT
 Roller only NEW! (4-28)
 Fits the new VPR274®

Code: VPR125

2.5mm BEARING SHAFT
 Roller only suit old.

Code: VPR124

VPR274 (Above) will replace assemblies in ALL units!



Roller Only - 2.5mm or 3mm

SAMSUNG

Original Part No: 61523002101
 Suit: VB300, VB370, etc.
 Code: VPR190

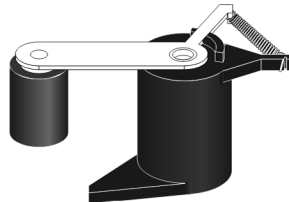

SANYO PINCH ROLLER

Original Part No: 613-151-8803
 Suit: VHR510,530, VHR590,610, VHR630,650.
 Code: VPR205



SHARP

Original Part No: MLEVF0281GEZZ
 Suit: VCA10,30,35,60,105, 111,115,125,505,etc...
 Code: VPR134

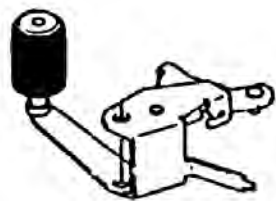

SHARP

Original Part No: MLEVF0416GEZZ
 Suit: VCA36X,37X,50X
 Code: VPR416

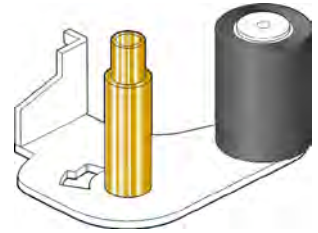

SHARP PINCH ROLLER

Original Part No: MLEVF0500GEZZ
 Suit: VCA220, 270,VCA420, 470.
 Code: VPR500

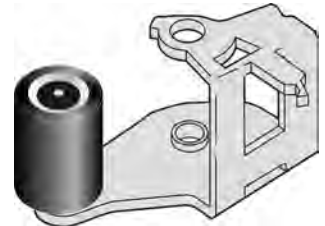

SONY PINCH ROLLER

A-6759-344-A NEW,
 X-3669-307-1, X-3670-063-1, X-3679-264-1,
 X-3691-646-1

Suit: SLC9, 34, 40, etc.
 Code: VPR195

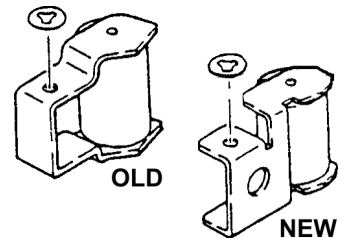

SONY PINCH ROLLER

X3749-173-4, X3749-770-1

Suit: SLV215,353, SLV757,777, SLVX30,X50, SLVX810,etc.
 Code: VPR200

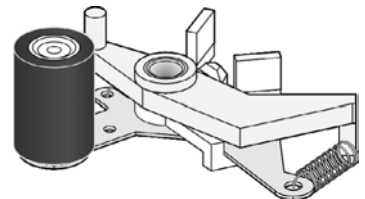

SONY PINCH ROLLER

A-6746-072-A

Suit: SLVX812, SLVX822
 Code: VPR202

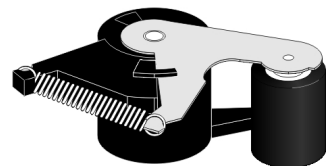

VCR REPAIR SECRETS ON A HANDY CD-ROM

Give you the correct advice and instruction on how to fix a particular VCR or TV problem. Indexed to Model & Faults and even uses 3PL part numbers.

Code: IKONCDR





→ Video Pinch Rollers

VIDEO PINCH ROLLERS AND ASSEMBLIES

Please note that the substitution listing is to be used as a guide only. There are many more models which are not listed. Please measure the roller required and choose from the dimensions listed.

Suit	Amm x Bmm x Cmm	Code
ORION VC-RLS, VL-BF, UD-LS	15 X 18 X 4	VPR35
GOLDSTAR 434-037D GHV SERIES.	18 X 17 X 4	VPR40
SONY ALL LATE MODEL VHS SLVX30,35,50,etc. Sharp VCA, VCH, etc.. ROLLER ONLY FROM VPR134 Philips VR6448, 6449, 6548, 6591,etc... Goldstar RG20, AWA AV66,etc... * Please Note! Similar outer dimensions to VPR121 *D = 7.7mm	14 X 18 X 3 X *	VPR50
SONY SLVX37, KV14VMIAS	17 X 19 X 4	VPR52
SONY SL-C5, C7, J7, T7, T9, 8000, 8080	16 X 19 X 3	VPR55
AKAI-VS10,9300, 9500, 9800, AKAI VP77, * HMV VP77 JVC-HR2200, 3300, 3330, 3660, RANK VP100 PALSONIC VCR5000, 6000	15 X 21 X 4	VPR56
NATIONAL NV250, 280, 370, 430, 450, 460, 470, 730, 770, 830, 850, 870, 2000, 3000, 7000, 7200, 8400, 8600, 8610, 8620 NV-G7, 9, 10, 11, 16, 30, ORION VH-1, 2, 2B PHILIPS VR6920, GENERAL VGX540A, 625A	18 X 23 X 3	VPR57
SANYO VTC5000, 5005, 5300, 5400, 5500, 6000, 6500, 9100, 9300, 9350, M10, M20, M30, M50 and others.	15 X 19 X 4	VPR58
NR0LR0005GEZZ SUITS EARLY MODEL SHARP VC6000,6300,7000 8000,9000, ALL 300 SERIES plus VC2300,3300 ORION VH3 AKAI VS11, 12, TEMPEST TE77R, TE90H, DISTAR DS757, PHILIPS VR401,501,502,701,901 AKAI VS11, PYE VRD100L SAMSUNG VB750, VB970,971, VB8220 PLUS OTHERS. THIS IS A VERY POPULAR TYPE USED IN TOO MANY MODELS TO LIST.	18 X 20 X 4	VPR59
HITACHI-VT7, 11, 14, 17, 33, 35, 88E, 4000, 4200, 5000, 6500, 6800, 7000, 8500, 9300, 9500, 9700, and FISHER FVH-P520, 530 and others.	15.5 X 22 X 4	VPR60
AKAI- VS9700	16.5 X 20 X 4	VPR61
AKAI- VS1, 2, 3, 4, 5, 6, 8, 15 and others.	13 X 18 X 3	VPR64
AKAI- VS112, 155, 165, 240, 515	18 X 20 X 3	VPR66
AKAI- VS33, 35, 53, 55, 66, 422, 425, 426, 427, 725, VSF10, 11, 220, 400, 410, 422, 425, 430, 600 * NOTE. THIS SUITS THE ONE PIECE TYPE ASSEMBLY. * SEE DETAILS ON THE NEXT PAGES FOR *AKAI PINCH ROLLERS	18 X 18 X 3	VPR67
AKAI VS202, 303, 606, 607 VSP8	16 X 20 X 3	VPR68
AKAI VS22, 35, 53, 66, 422, 425, 725 VSA77, VSF10, 11, 400, 410, 422, 425, 430, 600 * NOTE. THIS SUITS THE 2 PIECE TYPE ASSEMBLY.	18 X 18 X 3	VPR69
NEC ALL 900 & MANY 9000 SERIES, DX1600, DX3000, Original P/No. 016-17-8363, PALSONIC VCR9688, TEAC MV3010, 30, 50, MV4010, 6010.	16 X 19 X 4	VPR70
NEC DS6000A, N9073, N9570	15 X 17 X 4	VPR71
TEAC/FUNAI MV305, 307, 330, 400, 417, 430, 435, 440, 445, 450, MV1440TV, MV220TV GENERAL VGX815A PLUS EQUIVALENTS eg. CASIO, TANDY etc.	15 X 19 X 4	VPR72
MITSUBISHI AV SERIES AV12, 14, 47, 51, 58, 59, 400, 410, HS SERIES HS30, 304, 306, 307, 310, 318, 319, 337, HS338, 347, 349, 400, 410, 411, 412, SOME HSE SERIES HS-E10, 20, 70, 347 THORN TR102	15 X 18 X 4	VPR75

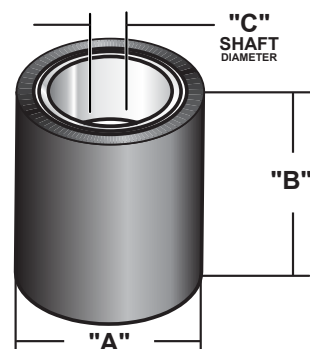

TOO MANY MODELS TO LIST HERE!

IF YOUR VCR IS NOT LISTED, PLEASE ENQUIRE!

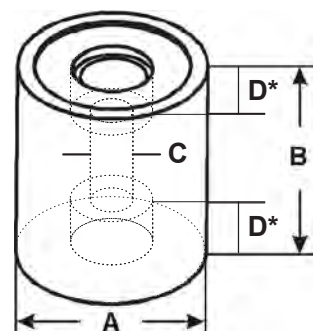



→ Video Pinch Rollers

VIDEO PINCH ROLLERS AND ASSEMBLIES

Suit	Amm x Bmm x Cmm	Code
MITSUBISHI HSE11, 12, 21, 27, 31, 41,... Also HSM and HSMX Series. SAMSUNG SV10, 11, 12, 30, 80, 81, 140 HITACHI VT100, 128, 135, 138, 168, FISHER FVH-P905, 908, 910, 911, etc.	14 X 17 X 3	VPR76
FISHER FVH-P620, 710, 720, 725	15.5 X 19 X 4	VPR78
FISHER FVH-P620, 710, 720, 725	15.5 X 21 X 4	VPR80
NATIONAL- NV100, 600, 300, 333, 777, 788, and BLAUPUNKT equivalents.	16 X 23 X 3	VPR87
JVC HR2650, 7200, 7600, 7610, 7655, 7650, 7700 GE-V9600 * HMV4000, 7000 RANK RV330, 340, 350 * T/FUNKEN VR530	17 X 21 X 4	VPR90
HRD170, 180, 200, 210, 230, 300, 320, 330, 337, HRD370, 377, 400, 430, 470, 530, 700, 750, 950, HRS5000, 5500, 9000, etc..	17 X 17 X 4	VPR104
JVC HR-D110, 111, 120, 121, 125, 140, 150, 160, 225, 250, 455, 565, 566, 755, NEC ALL 800 SERIES N830, 833, 895 ETC TOSHIBA V55, 57, 71, 73, 75, 81, 83, 84, 85, 86 GENERAL GE8100, 9300 THIS IS A VERY POPULAR TYPE USED IN TOO MANY MODELS TO LIST	17 X 18 X 4	VPR105
JVC HR-D230, D520, D521, D530, D540, D580, D600, D610, D620, HR-D830, HR-DX20EA, HR-S5800, & PHILIPS VR3241/75	16 X 17 X 4	VPR106
Philips VR2020, 2022, 2023, 2021, 2024	12.5 X 20.5 X 3	VPR107
SHARP all VC400 & 500 series eg. VC481, 581 etc. AKAI VS200 & VSP3, DEITRON DVR6158, ESC VCR8025, Philips VR6440, 6441, 6540, 6541, 6640, 6641, 6740 etc. Tempest TE99, TE900, TE970R, Tracton VCR32, VCR52, Orion VCP Samsung VB617C, 627, 629, 900, 910 etc. Marantz MV740A Goldstar GHV1232, 1240, 1246, 1291, 1295, 1296, etc Videopro VCR8025 THIS IS A VERY POPULAR TYPE USED IN TOO MANY MODELS TO LIST.	18 X 17 X 4	VPR108
NEC VN22, 23, 25, 26 97SB361200 DAEWOO DVR4773 70322134 2H20D 4H40D TOSHIBA V31, 33, 51, 53, 8600, 8650, 9600, VP88	15 X 17.5 X 3	VPR110
SHARP P/No. ROLR0013GEZZ Suit VC-6V3, VC600, 682, 685, 693 SHARP 700 SERIES VCA101, 103, VCH851, etc. PHILIPS 6442, 6443, 6520, 6542, 6543, 6549 etc. THIS IS A VERY POPULAR TYPE USED IN TOO MANY MODELS TO LIST	18 X 18 X 4	VPR113
SANYO 6130372161 VHR1300, 1500, 2500, 2700	16 X 23 X 3	VPR115
SANYO VHR3100, 3300, 3700, VHR-D500, D700	16 X 18 X 3	VPR116
SANYO VHR120, 4100, 5100, 5200, 5300, 5700, 7100, 7200, 7500 VHR-D4600, D4800, S700, VN-20, 31, 32, 70, 71, NEC VH81, 90, 91.	15.5 X 18 X 3	VPR117
ROLLER ONLY FROM VPR120, VXL1743 & VXL2676 Panasonic NVG series NVG20,21,22,25,40 AND MANY OTHERS. Panasonic NVJ, NVL, NVF, NVD series. SHARP LATE VCA SERIES BLAUPUNKT RTV560,740, etc... TEAC/FUNAI MV3410,4810 * Please Note! Similar outer dimensions to VPR50 and VPR123 *D = 8.3mm	14 X 18.5 X 3 X *	VPR121
ROLLER FROM VXL2785 (NOT VXL2676 - Check "C") Panasonic NVHD620A, 670A, NVSD220A, 270A, 420A. GOLDSTAR AF293, 493, 993, AC250, 450, 950. AKAI VSJ200, 215, 411, 416, 700, 711, 716. SANYO VHR-VK210, NEC VN204 * Please Note! Similar outer dimensions to VPR50 and VPR121	14 X 18.5 X 2.5	VPR123
NEW! - PHILIPS BLAUPUNKT TEAC, etc,	12.5 X 17 X 2.5	VPR124

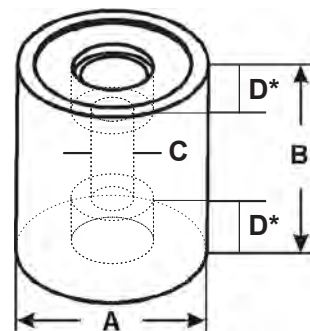

TOO MANY MODELS TO LIST HERE!

IF YOUR VCR IS NOT LISTED, PLEASE ENQUIRE!

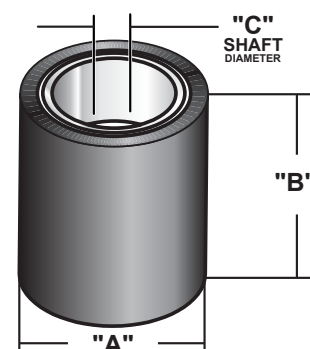



04 VCR COMPONENTS

→ Video Overhaul Kits

↓ JVC OEM

OVERHAUL KITS

The following kits are manufactured by the original corporations in Japan and contain all the parts which they recommend to be replaced when the VCR is being serviced.

Please note that many brands use the following kits. We have listed as many models as we are aware of and/or space would allow.

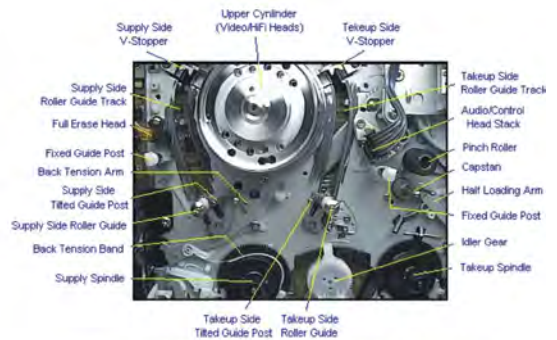

Typical VHS VCR Tape Transport Components

ORIGINAL JVC OVERHAUL KIT

Suit	HR-D120, HR-D225, NEC N830, 831, N833, GE GEV-7300, GEV-8100, GEV-9300, RANK RV360, RV370, 380.
	Code PTU96075

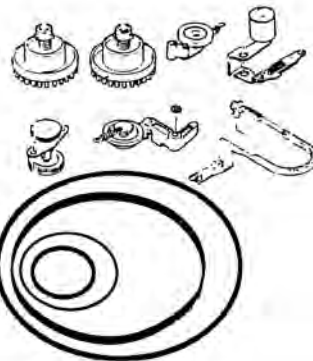

- PQM3003 BELT(D=46mm)
- PQM3003-7 BELT(D=116mm)
- PQM3003-8 BELT(D=28mm)
- PQM3004 BELT(D=27mm)
- PQM30017-5 SLIT WASHER X2
- PQM30017-8 SLIT WASHER X2
- PQ40134B PINCH ROLLER
- PU48907D REEL DISK ASS.
- PU48907E REEL DISK
- PU51390A TENSION BAND
- PU51402A T'UP IDLER ARM
- PU55373 T'UP CLUTCH
- PU55374-3-8 IDLER ARM

ORIGINAL JVC OVERHAUL KIT

Suit	HR-D455, HR-D725, TOSHIBA V63
	Code PTU96078-2

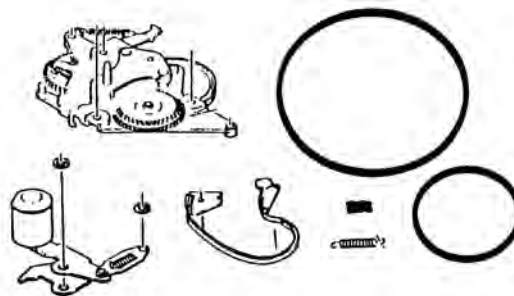

- PQM30003-10 BELT(D=55mm)
- PQM30003-14 BELT(D=30mm)
- PQM30017-12 SLIT WASHER X2
- PQM30017-8 SLIT WASHER
- PQ40252B-4 P'ROLLER & ARM
- PQ40262E TENSION BAND
- PU55822A-10 CASSETTE MECH.
- PQM30001-138 TENSION SPRING
- PQM30019-14 PAD

ORIGINAL JVC OVERHAUL KIT

Suit	HR-D160, 171, HR-D180, HR-D211, 230, HR-D300, 320, HR-D321, 337, HR-D470, 530, HR-D750, HR-S5000 HR-S5500
	Code PTU96079

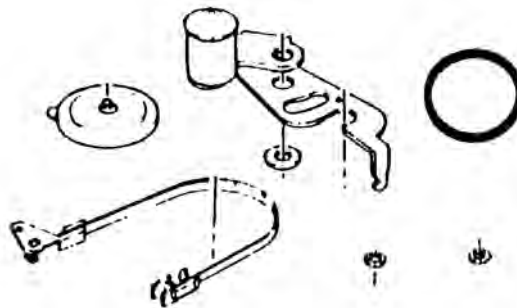

- PQM30003-20 BELT(D=19mm)
- PQM30017-28 SLIT WASHER
- PQM30017-5 SLIT WASHER X2
- PQ41948A TENSION BAND
- PQ42006B P'ROLLER & ARM
- PU58645-1-4 IDLER ARM

ORIGINAL JVC OVERHAUL KIT

Suit	HR-D540, HR-D580
	Code PTU96082

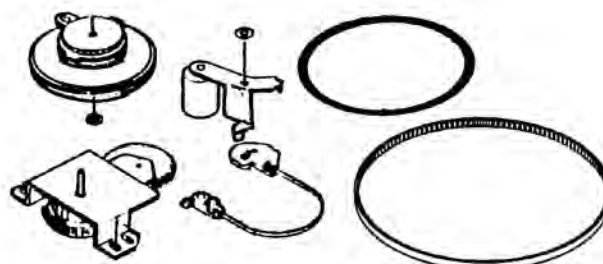

- PQM30003-23 BELT(D=64mm)
- PQM30017-12 SLIT WASHER
- PQM30017-8 SLIT WASHER
- PQ43501B-11 TENSION BAND
- PQ43921B-2 P'ROLLER & ARM
- PU61004-1-3 IDLER GEAR UNIT
- PU61005-1-4 CLUTCH UNIT
- PU61006 TIMING BELT

04 VCR COMPONENTS



ORIGINAL JVC OVERHAUL KIT

Suit HR-D520, HR-D521,
HR-D600, HR-D610,
HR-D620, HR-D830
Code PTU96083

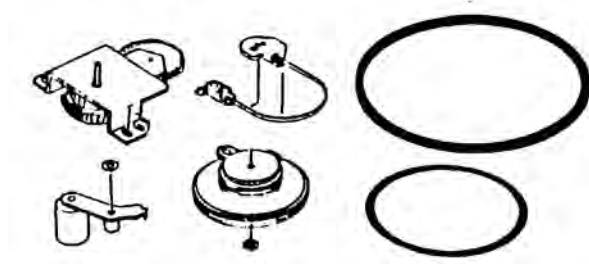

- PQM30003-23 BELT(D=64mm)
- PQM30003-24 BELT(D=93mm)
- PQM30017-12 SLIT WASHER
- PQM30017-8 SLIT WASHER
- PQ43501B-11 TENSION BAND
- PQ43558A P'ROLLER & ARM
- PU60618-1-3 IDLER GEAR UNIT
- PU60953-1-2 CLUTCH UNIT

ORIGINAL JVC OVERHAUL KIT

Suit HR-7200 & Equiv. GE
GEV6900, HMV HV4000,
RANK RV340
Code PTU96095

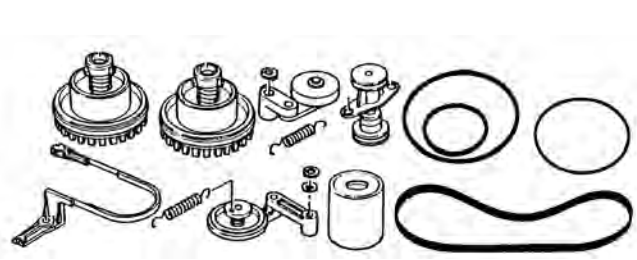

- PQM30003 BELT(D=45mm)
- PQM30003-2 BELT(D=64mm)
- PU48941-2 BELT(D=29mm)
- PU49164 BELT(D=88mm)
- PQM30017-5 SLIT WASHER X2
- PQM30017-6 SLIT WASHER X2
- PU48907C REEL DISK
- PU48907D REEL DISK
- PU48967B IDLER ASSEMBLY
- PU51367A PINCH ROLLER
- PU51390A TENSION BAND
- PU51402A TAKE UP IDLER
- PU53462A TAKE UP CLUTCH

ORIGINAL JVC OVERHAUL KIT

Suit HR-7600, HR-7650, HR-
7655, GE GEV8900, HMV
HV8000, RANK RV350
Code PTU96097-2

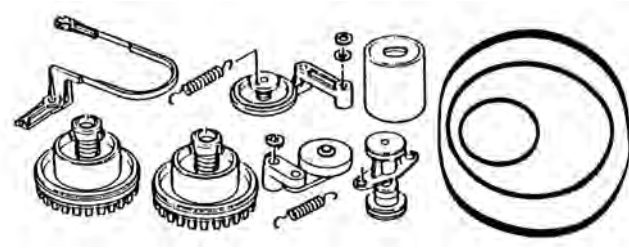

- PQM30003 BELT(D=46mm)
- PU48941-2 BELT(D=29mm)
- PU49164 BELT(D=88mm)
- PQM30017-5 SLIT WASHER X2
- PQM30017-6 SLIT WASHER X2
- PU48907D REEL DISK
- PU48907E REEL DISK
- PU48967B IDLER ASSEMBLY
- PU51367A PINCH ROLLER
- PU51390A TENSION BAND
- PU51402A TAKE UP IDLER
- PU53462A TAKE UP CLUTCH

↓ National Panasonic OEM

PANASONIC "G" MECHANISM PARTS KIT

Contains VXL1490, VXL1743,
VXP0878, VDG0597
VML1849, VMX1079, washers
and C rings. As the G mech
is very popular this kit will suit
many models eg.
NV-G20, 21, 22, 33, 40, NV-
D38, 48, FS1, H65, 75 etc, +
RTV740,560,etc.

Code
VUA4104

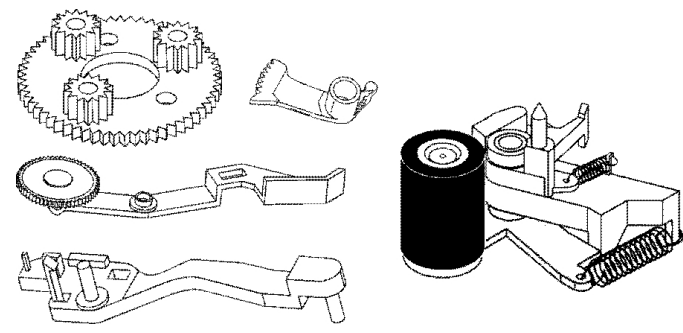

PANASONIC "G" MECH VIDEO MAINTENANCE PARTS KIT

Suit NVD38,48, NVF5
5,65,66,70,75,77
,NVG33,220,300,
NVJ1,10,11,30,35,45,
NVL10,15,20,P10,etc.
Code VUA4116KIT

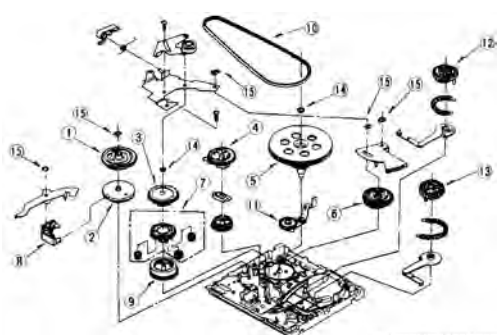

- VDG0574 Main Cam Gear
- VDG0343 Sub Cam Gear
- VDG0348 Centre Gear
- VDG0547 Clutch Gear
- VXP0917 Pulley Unit
- VDG0448 Loading Gear
- VXP0878 Gear Unit
- VML1861 Detent Arm
- VDG0342 Ring Gear
- VDV0169 Timing Belt
- VXL1861 Play Arm
- VDG0564 Load Gear T
- VDG0419 Load Gear



→ Video Overhaul Kits

↓ JVC Replacement

ECONOMY OVERHAUL KIT - JVC

Original & Non-original parts. Suit JVC HR3330, HR3600,3360, HR3660 and eq's. Contains; PU47752 Take up clutch, PU46381 Unloading idler Belts, tyres, Pinch roller

Code
VUD1101

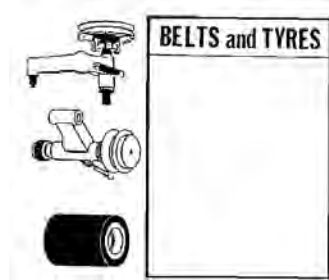

ECONOMY OVERHAUL KIT - JVC

Original & Non-original parts. JVC HR7200 7650, 2650 etc Contains; Idler assemblies PU51402A PU48967B, Take up clutch PU53462A belt kit Tyres pinch roller

Code
VUD1102

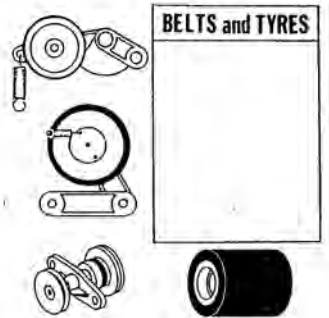

ECONOMY OVERHAUL KIT - JVC

Original & Non-original parts. JVC HRD-110, 120, etc. NEC N830,831,833 Contains; PU55373 Take up clutch, PU55374-3-8 PU51402A Idler arms Belts and Pinch roller.

Code
VUD1103

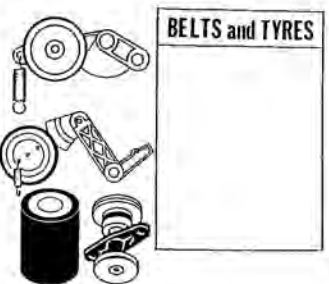

↓ National Panasonic Replacement

ECONOMY OVERHAUL KIT - NATIONAL

Original & Non-original parts. NATIONAL NV2000 Contains; VXZ0076 Tension band, VDP0908 Roller, VXP0329 Idler, VXP0331 Idler, VXPO351 Clutch, VXP0332 Brake belts, pinch roller Circlips & Washers

Code
VUD4087

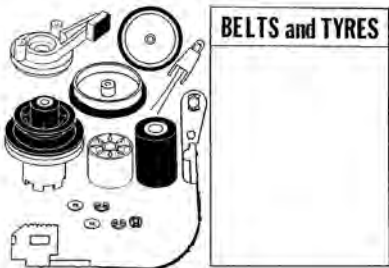

ECONOMY OVERHAUL KIT - NATIONAL

Original & Non-original parts. NATIONAL NV7000,7200... Contains; VXP0343 Idler, VXP0344 Idler, VDP0908 Roller, VXZ0078 Tension band belts,roller Circlips, and washers.

Code
VUD4088

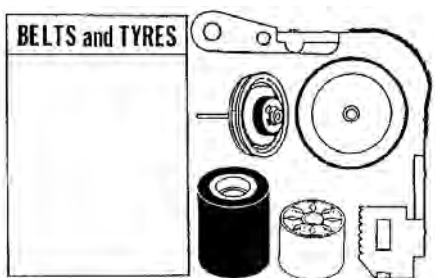

ECONOMY OVERHAUL KIT - NATIONAL

Original & Non-original parts. NATIONAL NV730, 770... Contains; VXP0581 Idler, VDG0177 Gear, VDP0908 Roller, VXZ0165 Tension band Belts,roller Circlips,etc.

Code
VUD4091

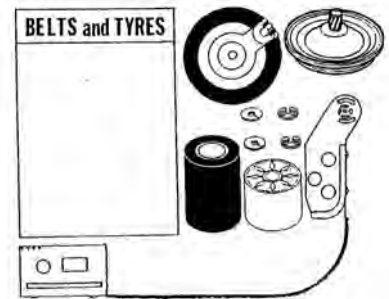

ECONOMY OVERHAUL KIT - NATIONAL

Original & Non-original parts. NATIONAL NV250, NV280, 470, 870... Contains; VXP0521 Idler, VDP0908 Roller, VXZ0165 Belts Pinch roller Circlips and Washers.

Code
VUD4093

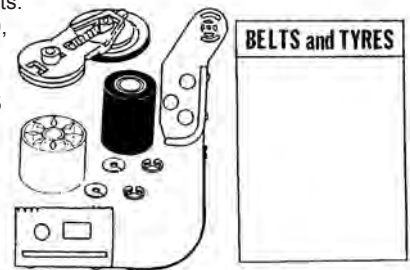

ECONOMY OVERHAUL KIT - NATIONAL

NATIONAL NV300, NV333, 340... Contains; VXP0434 Idler, VXP0401 Idler, VDP0908 Roller, VXZ0129 Tension band Belts & p'roller Circlips, washers.

Code
VUD4089

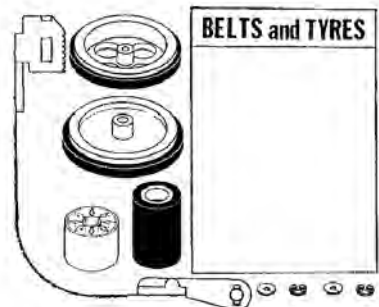

ECONOMY OVERHAUL KIT - NATIONAL

Original & Non-original parts. NATIONAL NV370, NV850... Contains; VXP0521 Idler, VDP0908 Roller, VXZ0165 Belt All belts, Pinch roller, Circlips and Washers.

Code
VUD4092

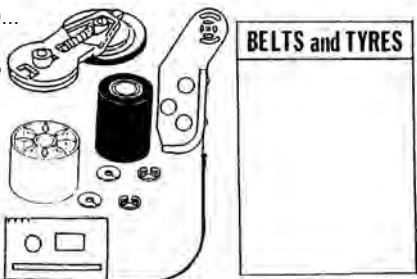

ECONOMY OVERHAUL KIT - NATIONAL

Original & Non-original parts. NATIONAL NV-G7→18 NVG30/H70/65... Contains; VXP0521 Idler, VXL1371 Roller ass'y, VXZ0165 Tension band Belts Washers and Circlips

Code
VUD4103

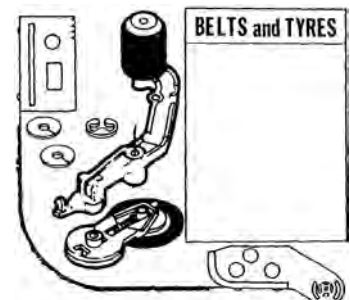



→ Video Sensors

VCR SENSING LAMP

Volts	Code
6	SL74-6
12	SL74-12



JVC SENSING LAMP

Suit HR7200 etc.
30cm lead.6 volt,70mA.
4mm Diam.

Code
SL15



JVC SENSING LAMP

As SL15
Including Plug.
20cm blue lead.

Code
SL25

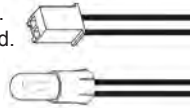

AKAI SENSING LAMP

VS1, 2, 3, 4, 5 etc.
12V 60mA. 50cm
lead.

Code
SL40



AKAI LAMP & HOLDER

Same as SL40

Code
SL42



SHARP SENSING LAMP

300 & 900 series
5V, 110mA, 18cm
lead.

Code
SL50



SHARP LAMP & HOLDER

As SL50

Code
SL52

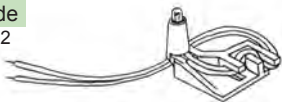

VCR SENSING LAMP

Suit older units

Volts	Code
12	SL79-12
6	SL79-6



NATIONAL PHOTO DIODE

Used in National
and other VCR's.

Code
PN202S-R



NATIONAL PHOTO DIODE

Used in National
and other VCR's.

Code
LN58



NATIONAL PHOTO DIODE

Used in National
and other VCR's.
Equiv. to GL450

Code
LN59



NATIONAL PHOTO DIODE

Used in National
and other VCR's.

Code
PN150



NATIONAL PHOTO DIODE

Suit many VCR's.

Code
PN268-R
LN68



NATIONAL SENSOR

Code
ON2170
ON2270



NATIONAL SENSOR

Used in National
and other VCR's.

Code
ON2160



GOLDSTAR SENSOR

Suits many models
and many brands.

Original Part No 513-194D
Code LN3194



NEC LED & HOLDER

Original Part No 16-19-1821
Equiv. 16-18-6441
Code LN1821

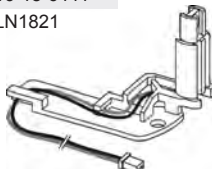

JVC REEL SENSOR

Original Part No JVC PU61433, Philips 4822 2099 0487

Suit HRJ220, 425, 635, HRS9400, RV455, VR155, 255, 257, VR357, 455, 755,
Code PU61433



JVC PHOTO DIODE

Suit HRD540, 860, X20, etc...
Code PU60625

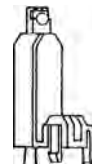

JVC SENSOR

Original Part No JVC HR-D725, NEC N895
Code PU55827

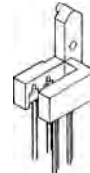

JVC SENSOR

Original Part No PU57650-1-1
Suit HR-D160, 275, 755, etc.
Code PU57650



JVC REEL SENSOR

Suit HRD540, 580, HRDX20, etc.
Code PS5705



JVC REEL SENSOR

Suit HRD170, 180, 530 HRD520, etc.
Code PU60271 PU60629

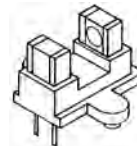

JVC SENSOR

Suit HR-D300, etc.
Code PU58879

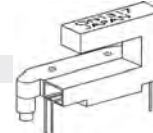

SHARP PHOTO DIODE

Original Part No RH-PX0039GEZZ
Code PX0039



SHARP SENSOR

Original Part No RH-PX0042GEZZ
Code PX0042

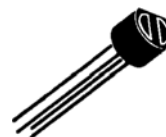

SHARP CASSETTE SENSOR

Original Part No RH-PX0169GEZZ, RH-PX0180GEZZ
Suit VCF410
Code PX0180



SECTION 2

LED Diodes Electronic
Components Section 2
COMPONENTS



SHARP IR SENSOR

Original Part No RHPX0176GEZZ, RHPX0053GEZZ
Code PX0176



SHARP SENSOR

Original Part No RHPX0238GEZZ
Code PX0238



↓ ROTATION SENSOR

ROTATION SENSOR

Original Part No RHPX0252GEZZ
Suit VCA200X
Code PX0252



↓ Reel Sensor

REEL SENSOR

IR TX & RX LEDs
Code PS6002A



↓ Infrared

INFRARED RECEIVER

Original Part No NATIONAL PN313B or PH302
Code PN313



INFRA-RED RECEIVER

PN323B, PH310, ED360409 and more!
Equiv. PH310
Code PN323



↓ OPTOCOUPLER SENSORS

OPTO COUPLERS

4N25
4N26
4N28
4N35
4N36
4N38A
ON3105
ON3105
ON3131
ON3171
PC111S
PC113
PC120
PC123
PC714
PC813
PC814
PC816
PC817





→ Brake Pads

AKAI BRAKE PADS

21mm x 5mm
Supplied in bags
of 10 pieces.

Code
ABP10



JVC BRAKE PADS

8mm x 2.5mm
Supplied 10 pcs/bag.

Original Part No PUM30019-2
Code JBP10



SANYO BRAKE PADS

21mm x 3.5mm
Supplied 10 pcs/bag.

Original Part No 613-055-7117, 143-2-712T-05200
Code SBP10



→ Brake Pads

ADHESIVE BRAKE PAD / TENSION BAND FELT

Supplied in a sheet 100mm x 70mm.
Just cut to size for application.
Light grey colour felt.

Code
TBF170



→ Switchmode Repair

PANASONIC SWITCHMODE REPAIR KIT

OEM kit by Panasonic.
Includes Resistors,
Diodes, Transistors,
Required for repair.

Suit NVSD200, 205,
NVSD207, 250,
Code VUE4127KIT



SONY SWITCH MODE

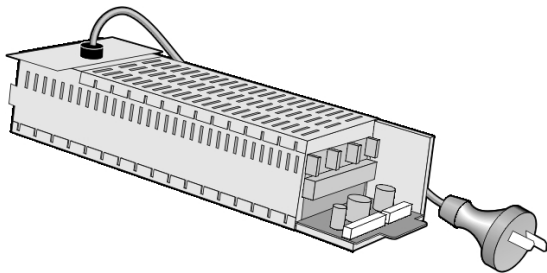

Original Part No	1-413-896-21	1-413-621-11	1-413-897-11
Suit		SLV777	SLVX835
Type	8 Pin		
Code	PS9621	PSM2111	PSM9711

→ PCB Modules

NATIONAL CHROMA PCBs

Code
VEFC007
VEFC009
VEFC013
VEFC015

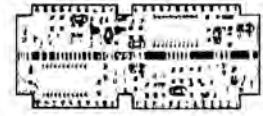

PANASONIC COLOUR MODULES

Suit Code
NVG30 VEFH03D
NVJ1 VEFH04F



PANASONIC COLOUR MODULES

Suit NVHD100,
NVSD1, 10
Equiv. VEFH29B,
VEFH29C
Code VEFH29D



→ Knobs

JVC KNOB SET

Suit Code
HRDX20EA PQ21174

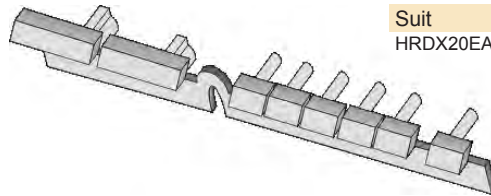

DOOR CATCH

FRONT FLAP CLOSE
As found on front door
flaps on VCRs, DVDs,
etc. Push to open
Push to close

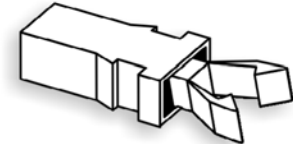

Code
DL1902

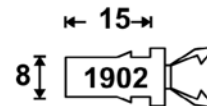

→ Crystal

SHARP CRYSTAL

Original Part No RCRSB0090GEZZ
Code CR0090

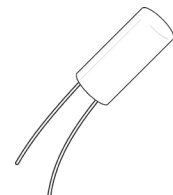

MORE X-TALS SEE
SECTION 2 COMPONENTS

→ Servicing Tools and Accessories

TOOLS & TEST EQUIPMENT - SECTION 14

SEE SECTION 14
TOOLS & TEST
EQUIPMENT

We also stock a large
range of hand tools
like screwdrivers
needle-nose pliers
NEW! Screw head
pliers! Cutters,
crimpers, seizure
clamps, assorted
sizes of metal &
plastic tweezers plus
lots more!

ABRIDGED VERSION

MORE AVAILABLE:

Idlers, Mechanism Parts,
AC Heads, Mode Switches,
Carriages, Tension Bands,
and more! Download PDF:

www.wescomponents.com/vcr/
Please request a catalogue:

Code
WES-SEC04



→ Servicing Tools and Accessories

VCR ALIGNMENT TOOLS

Three types are available to adjust AC heads, video heads, tape guide path, transport, etc.

Code HT36 HT87 HT89

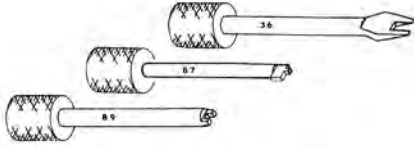

UNIVERSAL HEAD EXTRACTOR TOOL

Extract VCR heads without damage to either head or mounting assembly. Adjustable so as to suit various brand heads.

Code HT800

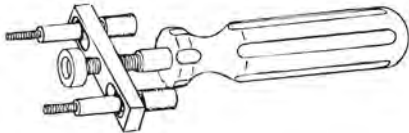

COTTON GLOVES

Eliminate the need to clean heads after fitting by using gloves. Recommended by leading manufacturers. Sold in pairs.

Code GLV2

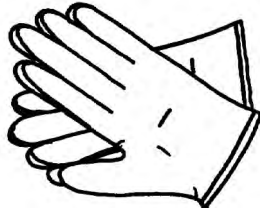

HAND ASSIST TOOLS

A collection of assorted hand tools scribes, hooks, blades, brushes, etc. designed to assist technicians in repair and servicing. Premium quality. Made in Japan.

Code SA10



HAND TOOLS

For our comprehensive servicemans tool range please see section 14 TOOLS & TEST EQUIPMENT

DENTIST MIRROR

Look behind things.

Code HT922



PEARL CATCHER

Oops! Retrieve dropped screws.

Code PU5

Please see section 14 TOOLS & TEST EQUIPMENT



SECURITY TAMPER LABELS

“WARNING - WARRANTY VOID IF SEAL BROKEN OR TAMPERED WITH.”

Place over screws and seals to prevent tampering. Suit repair shops, etc. Special type sticker that will not peel off in one go. Convenient dispenser box. Roll 500 pcs.

Code WL500

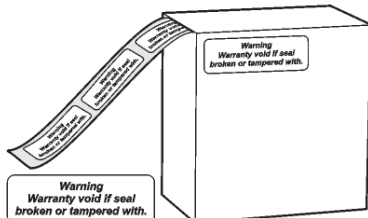

→ Servicing Tools and Accessories

VCR REPAIR HELP!



IKON AUSTRALIA FAULT CURES - UPDATED 2011

CD-ROM LIBRARY OF REPAIR INFORMATION TO SUIT TV & VCR

Easy money, simply look up the brand and model of the faulty VCR or TV and chances are, there will be a step-by-step description of how to repair the specific problem. Years of experience is now available at your finger tips! Save time on mis-diagnosis and stumbling how to remediate difficult or intermittent faults.

Code IKONCDR



→ Remote Controls

UNIVERSAL REMOTES See Section 20

We sell a comprehensive range of pre-programmed and programmable remotes for replacing damaged remotes and/or combining all your remotes into one.

Different styles and features available.

See section 20 MISC HOME THEATRE



REMOTE CONTROL REPLACEMENT CABLES

6M in length with molded plus & grommets. 3 Types of plugs.

Type 2.5mm plug 3.5mm plug
Code RCC25 RCC35

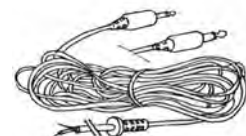

RUBBER KEYPAD REPAIR KIT

REMOTE CONTROL REPAIR

Restores conductivity to worn carbon contacts on remote controls & keypads. Repairs are good for at least 500,000 keystrokes. Carbon/silver solution.

50 Applications

Code CW2605



MECHANICALS GREASE

MOLYKOTE WHITE
Surfaces & Bearings.

Size Code
50g MK6195

MoS2 LM47 GREY
Metal bearings, etc.

Size Code
100g GR3510

POLYGLIDE CLEAR
Grease for plastics.

Size Code
35g GR5147



MORE SERVICE TOOLS
Tools Section 14 TOOLS & TEST EQUIPMENT



→ Servicing Tools and Accessories

GENERAL PURPOSE VHS TEST TAPE

This tape is designed as a preliminary service test tape for standard VCR's. Its cost effectiveness makes it suitable for initial fault finding and mechanical checking. It contains 30 minutes of colour bar signal and 1KHz audio tone.



Code VID50

VHS HI-FI ALIGNMENT TAPE

Includes 3KHz & 333Hz tones in linear & HiFi, Standard RF Sweep, etc. Ideal for final alignment. Master Tape.
8min Colour Bars
8min Stair Step
8min Circle & Border
8min RF Sweep



Code VID75

PRECISION VHS ALIGNMENT TAPE

Highest Quality recording. Suit final alignments.
8 min RF Sweep
8 min Colour bars 3KHz Tone
8 min Staircase Monoscope
333Hz Tone
6 min Crosshatch, Linearity (circle & border)



Code VID70

TRANSPARENT VHS WORKING CASSETTE

VCR servicing is made easier with this tape simulator. All functions normally but now you have access to the parts of the mechanism. Saves time and chewed tapes! Now with door tab simulator. Clear plastic.



Code VID5041

→ BLANK VIDEO CASSETTES

VHS VIDEO CASSETTE

Long-Life Anti-Fungus Treatment provides high reliability for long-term storage.

Brand Maxell*
Time 180 min
Code ME180GX



Extra High Grade ideal for archiving extra special recordings.

Brand TDK
Time 180 min
Code EHGE180



VHS-C COMPACT CASSETTE

TDK Extra High Grade Sony/Panasonic/JVC Brands may Substitute Limited Stocks Suits the VHS Compact format Used by JVC, Panasonic, etc.

Time 30min
Code VHSC30



*Brand may change to continue stock.

S-VHS SUPER VHS CASSETTE

Super-VHS PRO 240 Min Absolute premium solution High density magnetic tape With S-VHS identity tag as required to work as S-VHS TDK or JVC or FUJI Brands may be supplied. 240 Min.

Code SVHS240



8mm VIDEO CAMERA CASSETTE

To suit the Video-8 format Japan quality & durability* Sony or TDK may be supplied Depending on availability*

Time 85min
Code V8085



VIDEO CASSETTE COVERS

Video cassette storage cases for VHS and BETA Fitted with outer sleeve

Colour Clear Black
Code VCC2 VCC4

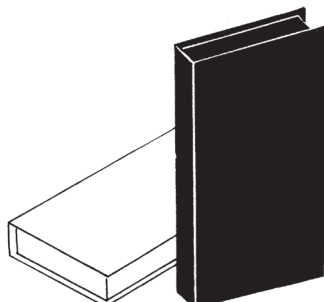

MINI-DV DIGITAL VIDEO CASSETTE

DVC CAMCORDER CASSETTES

Brand	Type	Time	Code
Panasonic*	90minLP	60minSP	DVC090
		120minLP	DVC120
Sony	HD	94minLP	DVM63HD
		63minSP	



*Brands may change to continue stock.



→ Servicing Tools and Accessories

CAMCORDER HEADCLEANER

Can be used wet or dry. Supplied with cleaning fluid. Non-abrasive

Type	VHS-C	8mm
Code	HL206	HL205



CASSETTE ADAPTOR VHS-C

Adapts the compact camcorder cassette to the normal size. VHS-C Cassettes ONLY! S-VHS Compatible [NOT 8mm/Hi-8] REQUIRES "AA" BATTERY

Code
EL303E

NOT FOR 8mm!



HEAD CLEANER VHS

Non-Abrasive polyester to clean the entire tapepath. Includes cleaning solution. Note this tape does not have a leader tape and may not function as expected in some machines.

Code
PC8002



VIDEO SPLICE KIT

Repair or modify VHS or BETA tapes with this splicing jig for precise control of cut & pasting. Includes jig, press, blade, adhesive tape and VHS & BETA leader tapes.

KIT

Code
PC8101



EXTRA CLEANING SOLUTION

Code
CS500

SUPER QUALITY VIDEO HEAD CLEANERS

Chamois Tip with 45° shaft. Packaged 10 per bag.

Code VCS10



VIDEO SPLICING TABS

Splice tabs for 1/2" video tape. Order one to receive a packet of 90.

Code
MK32



VIDEO CLEANING SWABS

Lintless foam swabs with a strong shaft. Packaged 20 per bag.

Code VCS20

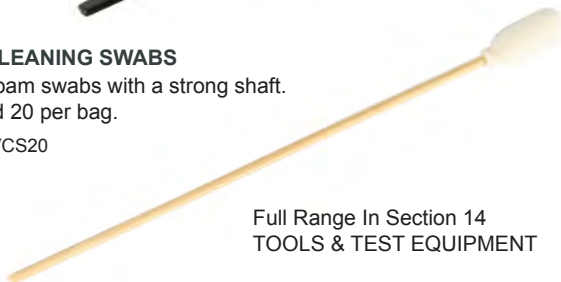

Full Range In Section 14
TOOLS & TEST EQUIPMENT

VIDEO TAPE SPLICER KIT

Defeats all hassles with repairing and modifying video cassette tapes. This handy unit has clips for holding the door open and releasing the reel ratchet. A grooved plate allows easy alignment of the tape with 'fingers' to hold it in position. Also includes a guillotine blade for accurate & neat splicing of the video tape. Suitable for both VHS & BETA tapes. Comes with instructions and splice tabs. Edit and repair is easy now.

Code
SV620

REPLACEMENT TABS

Splice tabs for 1/2" video tape. Order one to receive a packet of 90.

Code
MK32

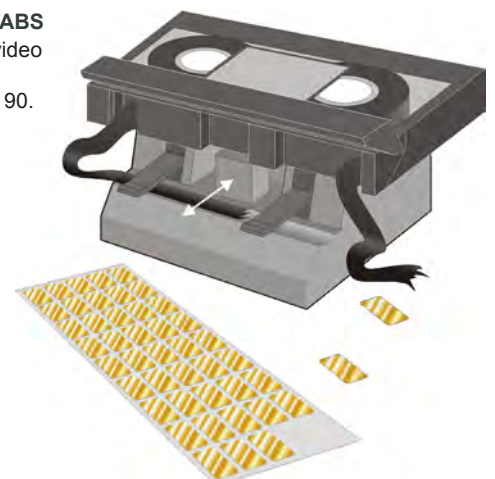

HEAD CLEANING SPRAY

Our full range is found End of Section 14 TOOLS & TEST EQUIPMENT

ELECTROLUBE 270g

Spray can non-residue Video Head Cleaner

Code
VID400M

SQUEEGEE BOTTLE 20ml

Isopropyl Alcohol

Code
CS505





YOU ARE VIEWING THE ABRIDGED VERSION

MORE VCR PARTS ARE AVAILABLE: There is an extensive range with thousands of Video Parts stocked. These are not listed here in this print due to space restrictions. Please refer to previous WES Catalogues for parts available or download the updated PDF catalogue (with ex GST pricing) here: <http://www.wescomponents.com/vcr/>

WES VIDEO PARTS CATALOGUE

A 100 page Video Parts Catalogue is available on request. For your free copy of this catalogue please enquire.

SONY CASSETTE HOUSING

Original Part No A6751496A, A6759603A, A6759623A, A6775357A
Suit SLVX812, SLVX822
Code CH9623

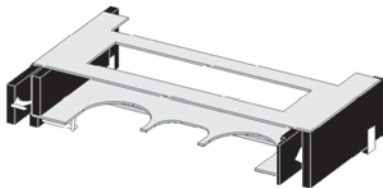

SONY MODE SWITCH

Original Part No 177115511
Suit SL-VEZ1, 10, SL-VEZ7, 70.
Code SW5511



PANASONIC SIDE PLATE

Suit NVL20, 25, 'G' Mech
Code VXA4076

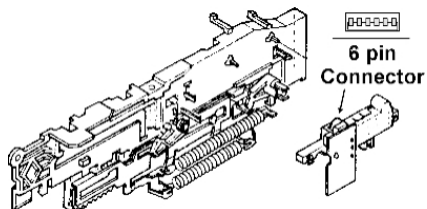

PANASONIC MODE SWITCH

Suit NVSD10A, NVSD20A, NVSD30A
Code VSS0365

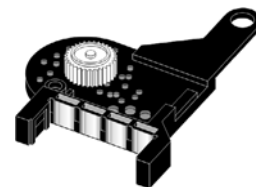

PANASONIC LOADING ARM

Suit NVSD220, 270, NVSD420, NVHD620, 670.
Code VXL2672

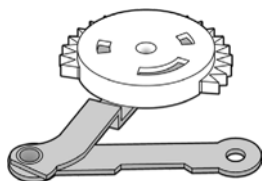

PANASONIC MODE SWITCH

Original Part No VSS0520
Suit NVSD220, 270, NVSD420, NVHD620, 670.
Code VSS0520

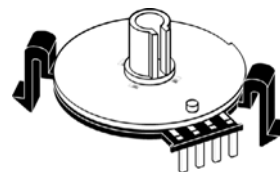

PANASONIC LOADING ARM

Suit NVSD220, 270, NVSD420, NVHD620, 670.
Code VXL2670

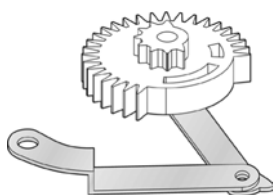

SHARP CAPSTAN MOTOR

Original Part No RMOTN-2038, 2047, 2048-GEZZ
Suit 14VT10X1, VCA33,34,38,39, VCA48,49,63,64, VCH83,84,85,87, VR3261, VF22, etc.
Code VM2038



PANASONIC IDLER ASSEMBLY

Original Part No VXP0521
Suit NV250,450, G10 etc.
Code VXP0521



PANASONIC TENSION BAND

Suit NV300, 600, NV777, etc. AG6200, RTV321.
Code VXZ0129



PANASONIC "G" MECHANISM PARTS KIT

Contains VXL1490, VXL1743, VXP0878, VDG0597 VML1849, VMX1079, washers and C rings. As the G mech is very popular this kit will suit many models eg. NV-G20, 21, 22, 33, 40, NV-D38, 48, FS1, H65, 75 etc, + RTV740,560, etc.

Code VUA4104

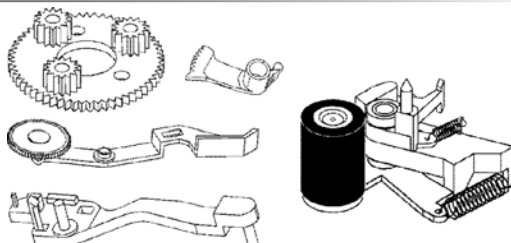

PANASONIC ROLLER POST

Suit NV730, NEC 911A
Code VXP0444A

