



SECTION 14

TOOLS & TEST EQUIPMENT



14

SECTION CONTENTS

→ Hand Tools	2
↓ Screwdrivers	2
↓ Hex Drivers	4
↓ Hex Bits	5
↓ Screwdrivers	6
↓ Screwdrivers Micro	7
↓ Tweezers	9
↓ Allen Keys & Files	10
↓ Tools Sets	11
↓ Crimpers	12
↓ Strippers	15
↓ IDC Punch-Down	15
↓ Knives	15
↓ Saws	16
↓ Cutters	16
↓ Pliers	18
↓ Safety Equipment Gloves	20
↓ Safety Equipment Ear	21
↓ Cable Puller	22
↓ Storage Boxes	24
↓ Measurement Tools	25
↓ Mirror	26
↓ Magnifiers	26
↓ Lighting & Torches	28
↓ Hot Glue Gun & Glues	29
↓ Blow Torches	29
→ Soldering	30
↓ Soldering Irons - Hand Iron	30
↓ Soldering Irons - 12V & Battery	31
↓ Soldering Irons - Gas	32
↓ Soldering Irons - Weller	33
↓ Soldering Irons - Hakko	36
↓ Soldering Irons - Induction	39
↓ Desoldering Gun	41
↓ Smoke Extractors	42
↓ Solder	42
↓ Solder Accessories	43
↓ Desoldering	45
→ Service Tools	46
↓ Electro-Static Device	46
↓ Television and Monitor	47
↓ Isolation Transformers	47
↓ Pattern Generators	48
↓ Pattern Generators	49
↓ Test Discs and Tapes	49

SECTION CONTENTS

→ Measurement	50
↓ Signal Strength	50
↓ Communication	51
↓ Miscellaneous	51
↓ Appliance	52
↓ Meterman Amprose Tools	54
↓ Analog Multimeter	55
↓ Other Multimeters	55
↓ AC Clamp Meter	55
↓ Lutron Multimeters	56
↓ Other Multimeters	57
↓ Cable Testers	58
↓ Accessories	59
↓ Appliance	60
↓ Stud Finder	60
↓ Cable Testers	61
↓ HCK Silicone Test Leads	64
↓ Books	66
↓ Test Discs and Tapes	67
→ Service Aids	68
↓ Tape	68
↓ PCB	70
↓ Heat Transfer	70
↓ Silastic and Sealant	70
↓ Oils	70
↓ Glues	70
↓ Grease Lubricants	71
↓ Wipes Cleaners	72
↓ Isopropyl	72
↓ Brushes	74
↓ Cleaning Swabs and Applicators	74
↓ Gloves	75
↓ Grease Lubricants	76
↓ Silicone	76
↓ Aerosols	76
↓ Cleaning Swabs and Applicators	76
↓ Freezer	76
↓ Aerosols	76
→ Screws	78
↓ Miscellaneous	79
↓ Storage Boxes	79
↓ Power Tool	80
↓ Jigsaw Blades	80
↓ Drill Bits	80
→ Inspection Cameras	82



→ Hand Tools

↓ Screwdrivers

PHILLIPS HEAD SCREWDRIVERS

Chrome Vanadium Hardened. Sold individually with SOFT rubber handle for easy grip.

Shaft	POINT	Code
10cm	4mm,00	HT600
10cm	4mm,0	HT605
15cm	4mm,1	HT610
10cm	5.5mm,1	HT650
10cm	6.5mm,2	HT655

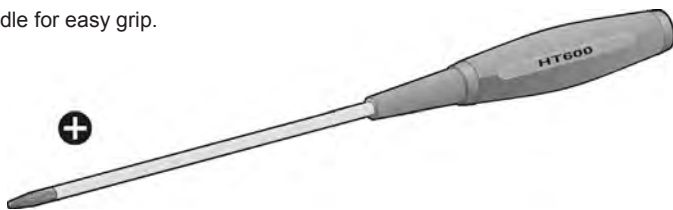

FLAT BLADE SCREWDRIVERS

Chrome Vanadium Hardened. Sold individually with SOFT rubber handle for easy grip.

Shaft	Diam.	Code
10cm	4.0mm	HT620
20cm	4.0mm	HT625
10cm	5.5mm	HT680
15cm	6.0mm	HT690

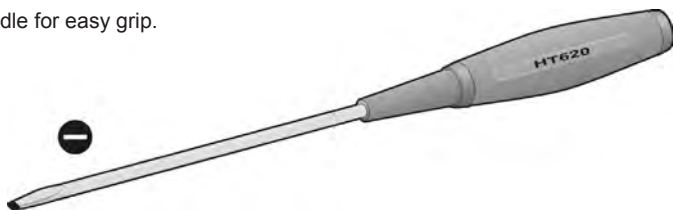

VERY LONG SCREWDRIVERS

POINT	Shaft	Code
4.5mm, No. 1	250mm	HT1250
5.5mm, No. 2	250mm	HT2250

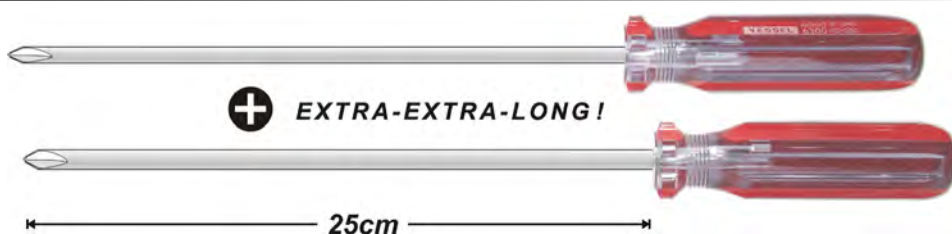

VESSEL CUSHION GRIP SCREWDRIVER KIT

5 Piece kit in a vinyl pouch. Chrome-vanadium hardened. Comfortable cushion rubber grip for non-slip, greater torque & control with less fatigue. Highest Quality. Made in Japan. Shaft lengths may vary slightly.

Shaft 100mm Phillips #1, 100mm Phillips #2, 150mm Phillips #2, 75mm Slotted 5.5mm Blade, 100mm Slotted 6.0mm Blade

Code
HT5600



ELECTRICAL INSULATED 7PC SCREWDRIVER SET

DVE IEC60900:2004 PREMIUM GRADE PROFESSIONAL SET

High Quality 1000V insulated Phillips / Blade screw driver set Bright CAT-III Red in colour. Insulated shaft protection Ideal for electrical applications. Large easy-grip comfortable rubber double molded handle. Packaged in a hand plastic tool casing for portable storage.

Phillips #0 #2 #3
Blade 3.5 4.0 5.5 6.5mm

Code
HT78017



BLADE	PHILLIPS
1.2x6.5x150	Size: PH2x100
1.0 5.5x125	PH1x80
0.8 x4x100	PH0x60
0.6x3.5x75	300x205x55mm

INSULATED SCREWDRIVER KIT 1,000 V

Contains 4 blade type & 3 Phillips type drivers. 1000V fully insulated. Various shaft lengths and tip sizes. Chrome-vanadium steel for extended wear. Also contains a neon 100V - 500V AC tester.

Code
HT550





PHILLIPS REVERSIBLE SCREWDRIVER

TWO SIZES [DOUBLE] IN-ONE DRIVER

Long-Life Chrome Vanadium Hardened tipped. Reverse the 1/4" HEX shaft to change tip size. Two common Phillips Cross-Blade available. Easy-Grip handle with one flip shaft each.

Order one to receive one handle and one shaft. Compatible with HT1101, etc.

Length	POINT	Code
25cm	#1 & #2	HT4001
25cm	#2 & #3	HT4002

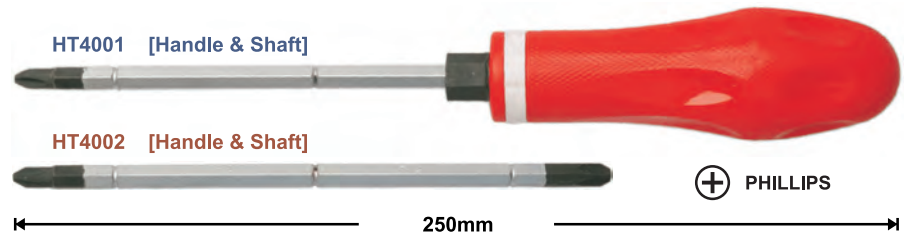

20-IN-1 SCREWDRIVER KIT

HANDLE WITH FLIP-SHAFTS IN A CASE

Supplied with one handle and 10x double ended shafts. Two locking positions for SHORT or LONG SHAFT positions. Large easy grip double molded handle with comfortable rubberized. Simply choose the shaft with the appropriate vanadium hardened tip, insert into the handle and lock into place at the desired shaft length. Torx / Pozi / Hex / Phillips / Blade screwdriver tips. Packaged in a hand plastic tool casing for portable storage.

Code
HT1101



- ⊕ PHILLIPS
Size: 1, 2, 3
- ⊖ BLADE
Size: 4, 4.5, 5.5, 6.5
- ⊙ HEX
Size: H3, H4, H5, H6
- ⊗ POZI
Size: P21, P22, P23
- ⊛ TORX
Size: T10, T15, T20, T25, T30, T40

DELUXE MULTI-DRIVER KIT

42 PIECE SCREW DRIVER SET

8 Pieces of common sized hand grip screw drivers with comfort grip rubber 7 Pieces of jeweller sized thumb drivers of blade and phillips head tips. 12 Piece (x2) double sided HEX bits with comfort-grip rubber handle driver. Bonus flexible HEX bit extension arm for hard to reach screws, etc. Packaged in a hand plastic tool casing for portable storage. Includes Blade, Phillips, HEX, Pozi and Torx drives Handy, heavy-duty Transport case 400x270x60mm

Code
GSD306



- ⊕ PHILLIPS
Size: 00 up to 3
- ⊖ BLADE
Size: 2.5 up to 8
- ⊙ HEX
Size: T10 up to T40
- ⊗ POZI
Size: 0 up to 3
- ⊛ TORX
Size: T10 to T40

Case Size: 400x270x60mm

SCREWDRIVER SET 7 PIECE

MEDIUM & FULL SIZED

Chrome vanadium. Magnetic Tempered hardened tips. Double moulded handles. Soft rubber easy-grip. Blade 3x75, 5x75, 6x100mm Phillips Head PH0/75mm PH1/75, PH2/100, PH2/150mm.

Code STD7256

MADE IN TAIWAN



SOCKET & WRENCH SET 29 PIECE

HIGH-QUALITY MINI-SET 6" RATCHET

Brushed-finish Chrome-Vanadium steel 150mm ratchet and 150mm hand driver. Tommy-bar, extension bit & uni-elbow 12 Piece metric socket 4mm to 13mm 12 Piece bit set. HEX, Phillips, etc. Packaged in a hand plastic tool casing.

Code
GTK231



MINI-RECHARGEABLE CORDLESS SCREWDRIVER

Rubberized plastic, easy to use, gun shaped for comfort, better grip and higher torque. Compact size 140x130mm. Easy portability in a tool box. Drive = 180rpm 2nm Built-In LED Torch to assist in low light areas Reverse/Forward dual action trigger button 3 LED battery status indicators. 4.8V NiCD Includes AC charger and driver bits (x4) Standard 1/4" HEX socket suits most bits.

Code
CD2498





↓ Hex Drivers

APEX 1/4" HEX DRIVER USA

Quality construction by Apex USA from chrome vanadium steel for tough reliable tool action. Non-magnetic tip holder suits all 6mm Hex tips.

Code
HT1500P
MADE IN USA



SOCKET DRIVER

DEEP NUT DRIVER 8mm & 10mm

Long throat for nut on thread affixing. Premium grade Japan SUN-FLAG. Rubber Grip.

Size Code
8.0mm HT808
10.0mm HT810



APEX 1/4" HEX DRIVER

Handle is hollow and capped for storing some tips. Quality construction from chrome vanadium steel for tough reliable tool action. Magnetic tip holder for holding screw on head. Suits all 6mm Hex tips.

Code
HT1025
MADE IN TAIWAN



SUN-FLAG RATCHET 1/4" HEX

Standard sized driver with four hardened bits included. Suitable for any 1/4" bits. Ball bearing lock system. left/right/fixed Ratchet. Quality Japan construction. 220mm. Cavity storage handle.

Code
HT1800
MADE IN JAPAN



VESSEL T-BAR DRIVER 1/4"HEX

Can fasten & remove a screw with correct wrist control, giving better torque & grip. Beware of cheap imitations without the 'L' shape shaft. This shaft won't slip! Magnetic tip holder. Soft handle, Chrome Vanadium. 170mm long inc' handle, not tip. Original patent design. Tips supplied separately.

Code
HT9600
MADE IN JAPAN



MICRO-DRIVERS RATCHET 62 PIECE

WITH SECURITY TIPS

Heavy-duty ratchet driver Precision tool. Comfort grip. with a collection of 59 tips Including standard driver tips and security tamper-proof bits butterfly, snake-eye, torx®, etc. Magnetic drill adapter socket.

Code ST26092



MADE IN TAIWAN

VESSEL RATCHET DRIVER 1/4" HEX

Flat plate ratchet design for precise controlled torque action to remove any stubborn screws, etc' with the correct action and reduced risk of damage. Comes complete with 10 tips mounted in a belt clip. 125mm long.

Code
HTD70
MADE IN JAPAN



VESSEL T-BAR DRIVER 1/4" HEX

Can fasten & remove a screw with correct wrist action, giving better torque, grip, comfort and control. Japan quality construction, this handle will not slip of the shaft! Patented. 110mm long. Magnetic. Suit all 1/4" tips. Chrome Vanadium. Comes with 5 Phillips/blade bits.

Code
HTD90
MADE IN JAPAN



VESSEL T-BAR RATCHET 1/4" HEX

Comfortable grip & action with repeated wrist turns. Left/Right/Fixed ratchet. Reliable multi-purpose hand tool kit with T-grip. Suit 1/4". Supplied with 5 Phillips/ Blade bits. 100mm long.

Code
HTD80
MADE IN JAPAN



SUN-FLAG 1/4" HEX STUBBY DRIVER

Low-profile solution. Suits any 1/4" bits. Includes a double ended blade & cross-head bit. Suits No.1, 2, 3. Premium triple molded. Handy Cup-Screw slot.

Code
HTD96
MADE IN JAPAN



SUNFLAG 1/4" HEX WITH FLEXIBLE SHAFT

RATCHET DRIVE
175mm Flexible shaft. Hex to Hex all-metal Heavy-duty construction can also be used with electronic screw drivers Detachable Stubby driver with Ratchet (Switched) Professional grade tool Bend & twist into many awkward places. Includes 2x 1/4" Bits Highest quality in feel & construction. Product of Japan.

Code
HT193FB





↓ Hex Bits

MAGNETIC DRILL BIT ADAPTOR

Allows quick connection of 1/4" Hex bits with drills. Magnetized. Made in USA. 76mm long.

Code HTCM40



DRILL BIT ADAPTOR ONLY
1/4" TIPS SOLD SEPARATELY
1/4" HEX TIPS

PREMIUM GRADE HARDENED STEEL LONG LIFE TIPS
OFFICIAL PATENTS

BLADE 1/4" HEX TIPS

Size	Diam.	Code
4F / 5R	6.2x.85mm	HEX204
8F / 10R	6.2x1mm	HEX208
10F / 12R	6.2x1.3mm	HEX210

PREMIUM GRADE HARDENED STEEL
LONG LIFE TIPS OFFICIAL PATENTS

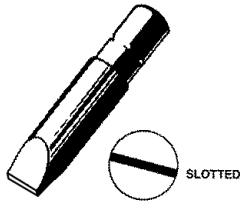

PHILLIPS 1/4" HEX TIPS

Size	Code
#2	HEX402
#3	HEX403

PREMIUM GRADE HARDENED STEEL
LONG LIFE TIPS OFFICIAL PATENTS

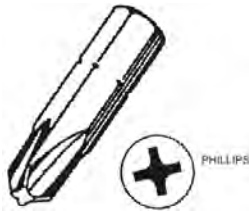

POZI-DRIVE 1/4" HEX TIPS

Size	Code
#2	HEX442
#3	HEX443

PREMIUM GRADE
HARDENED STEEL
LONG LIFE TIPS
OFFICIAL PATENTS



PHILLIPS PIN-HEAD 1/4" HEX TIPS

Size	Code
#2	HEX482
#3	HEX483

PREMIUM GRADE
HARDENED STEEL
LONG LIFE TIPS
OFFICIAL PATENTS



TORX TAMPER PROOF 1/4" HEX TIPS

Size	Diam.	Code
#3	0.9mm	HEX803
#4	1.1mm	HEX804
#5	1.3mm	HEX805
#6	1.5mm	HEX806
#7	1.7mm	HEX807
#8	2.0mm	HEX808
#9	2.2mm	HEX809
#10	2.5mm	HEX810
#15	3.0mm	HEX815
#20	3.6mm	HEX820
#25	4.0mm	HEX825
#27	4.3mm	HEX827
#30	4.8mm	HEX830

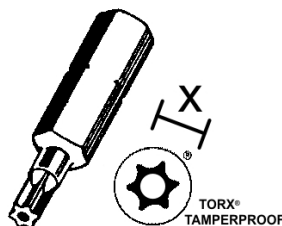

PREMIUM GRADE
HARDENED STEEL
LONG LIFE TIPS
OFFICIAL PATENTS

TRI-WING 1/4" HEX TIPS

Size	Diam.	Code
W2	4.7mm	HEX302
W3	4.7mm	HEX303
W4	6.3mm	HEX304

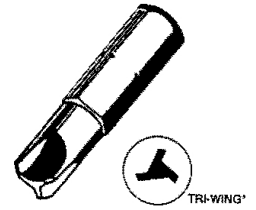

SNAKE EYE 1/4" HEX TIPS

Size	Gap	Code
#4	1.5mm	HEX704
#6	2.0mm	HEX706
#8	2.5mm	HEX708
#10	3.3mm	HEX710
#12	4.0mm	HEX712
#1/4	4.5mm	HEX714



SOCKET PIN HEAD 1/4" HEX TIPS (Metric)

Size	Code
2.5mm	HEX625
3mm	HEX630
4mm	HEX640
5mm	HEX650

PREMIUM GRADE
HARDENED STEEL
LONG LIFE TIPS
OFFICIAL PATENTS

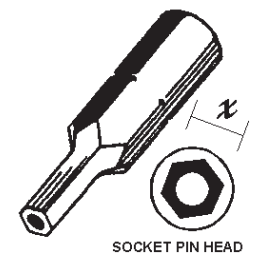

SOCKET PIN HEAD 1/4" HEX TIPS (Imperial)

Size	Code
3/32", 2.3mm	HEX633
1/8", 3.1mm	HEX618

PREMIUM GRADE
HARDENED STEEL
LONG LIFE TIPS
OFFICIAL PATENTS

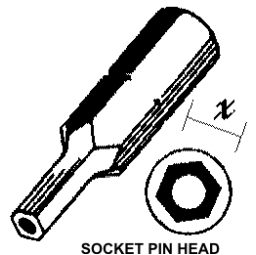

AUTOMOTIVE PROFESSIONAL TOOL KIT

11 PCS 5-POINT SPECIAL BIT SET

Professionals Choice Special automotive kit. Very low wear and tear long lasting material. Pocket size and very Light weight. Kits Includes T10, T15, T20, T25, T27, T30, T40, T45, T50, One 1/4" square drive x 1/4" hex socket adaptor and one 1/4" hex drive, 60 mm long bit holder. Size :114x55x20 mm

Code
DA9728



32 HEX BIT KIT

INCLUDES SECURITY BITS

Excellent selection of 1/4" HEX Bits for use with Cordless drills, etc.. Economical. Made in China Inc. many security bits Torx, Tri-wing, Pin-Head, etc.

Code
HT2551





↓ Screwdrivers

TRI WING SCREWDRIVERS

Chrome Vanadium Hardened tips
Premium professional grade tool
Full length driver (shaft)
Secure grip handle

Size	Shaft	Diam.	Code
TW2	10cm	4.8mm	HTW2
TW3	10cm	4.8mm	HTW3
TW4	15cm	6.4mm	HTW4
TW5	15cm	6.4mm	HTW5

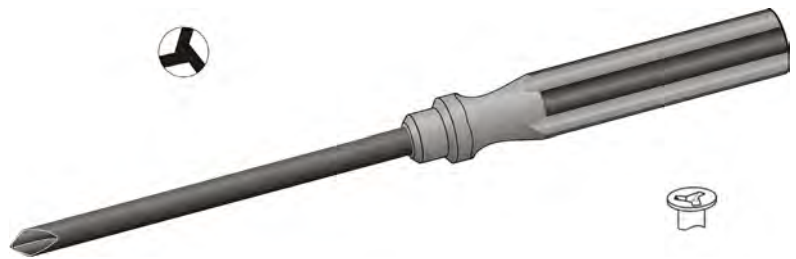

TORX SCREWDRIVERS

Sold individually. Premium grade quality tool. 10cm long shaft with rubber soft grip handles.

Size	Diam.	Code
T5	1.4mm	HT5H
T6	1.8mm	HT6H
T7	2.0mm	HT7H

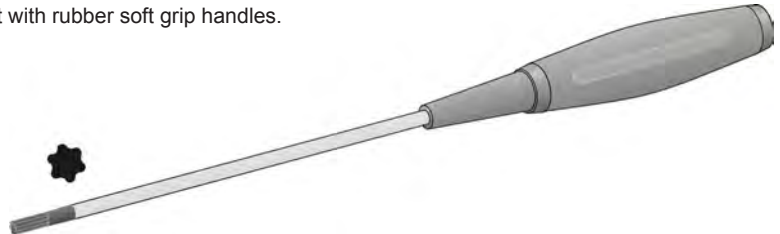

ECONOMY T6 DRIVER

125mm total length. Suit Nokia, etc.

Size	Diam.	Code
T6	1.8mm	HT1006



TORX TAMPER PROOF

Sold individually. 10cm long shaft

Size	Diam.	Code
T8	2.25mm	HT8H
T9	2.50mm	HT9H
T10	2.70mm	HT10H
T15	3.25mm	HT15H
T20	3.80mm	HT20H
T25	4.40mm	HT25H
T27	5.00mm	HT27H
T30	5.50mm	HT30H



TORX TAMPER PROOF - LONG SHAFT

Chrome Vanadium Hardened. Sold individually. 20cm long shaft

Size	Diam.	Code
T8	2.25mm	HT8HLG
T10	2.70mm	HT10HLG
T15	3.25mm	HT15HLG
T20	3.80mm	HT20HLG
T25	4.40mm	HT25HLG
T27	5.00mm	HT27HLG
T30	5.50mm	HT30HLG



TORX TAMPER 7 PIECE SCREWDRIVER SET

High Quality Large easy grip double molded handles with comfortable rubberized handle, Chrome-Vanadium with hardened tips for long life. Can be used for special security Torx screws and standard Torx screws. Packaged in a hand plastic tool casing for portable storage. Contains sizes: T10, T15, T20, T25, T27, T30, T40

Code
HT78007



DOUBLE MOLDED WITH RUBBER GRIP

MINI-THUMB-DRIVER SET WITH 28 BITS

Compact, high quality, comfortable, metal thumb-driver kit. Includes a popular set of jeweller driver bits (hardened tip). Includes some extra security driver bits and a carry case. With extension shaft that doubles as a tommy-bar.
Phillips #000 #00 #0 #1 #2
Blade 1.5 1.7 2.0 3.0 4.0mm
HEX HN3 3.5 4 4.5 5 5.5 6
Triangle, Tri-Bit, and Torx (x8)

Code
GTK2130



Case Size: 135x110x27mm



↓ Screwdrivers Micro

BLADE JEWELLERS SET

6 piece screwdriver set.
Plastic Handle. Metal Tips.
Sizes:
1.0mm,
1.4mm,
2.0mm,
2.4mm,
3.0mm,
3.8mm
Code HT400



PHILLIPS HEAD JEWELLERS SET

5 piece Phillips head
Plastic Handle. Metal
Tips.
Sizes:
OOO,
OO,
O,
1, 2
Code HT410



SCREWDRIVER SET

6 piece Swivel tops
Flat Plastic Handle. Metal Tips.
Blade: 1.2, 1.8, 2.4, 2.9mm
Phillips: O, 1
Code HT420



MICRO-DRIVERS SET 6 PIECE

BLADE & CROSS-HEAD
Deluxe heavy-duty made
Soft rubber comfort grip
Twist thumb swivel back
105mm long shaft driver
Heavy-duty storage case
Cross-Head 00, 0, 1.
Blade 2.4, 1.8, 1.4mm.
Code STD711



MICRO-DRIVERS SET 6 PIECE

STAR DRIVER HEAD
Deluxe heavy-duty made Soft rubber
comfort grip Twist thumb swivel back
105mm long shaft driver Heavy-duty
storage case Star head (Like Torx®)
T5, T6, T7, T8, T9, T10
Code STD712



MICRO-DRIVERS SET 15 PIECE

COMBINES ABOVE KITS+
Deluxe heavy-duty 100mm Kit contains
15 drivers Cross-Head 00, 0, 1. Blade 2.4,
1.8, 1.4mm Star head (Like Torx®) T5, T6,
T7, T8, T9, T10 Hex H1.5, H2.0, H2.5mm.
Code STD713



MICRO-DRIVERS MIN SET 4 PIECE

POCKET FIT
Jewellers screw driver
Changeable tips to suit
Includes handy case Mini screw
container Blade 1.5, 2.4, 3,
3.5mm Cross-Head 0 and 1.
Length 100mm
Code HT390



MICRO-DRIVERS KIT 21 PIECE

CHANGEABLE TIPS
Compact case includes
Deluxe soft grip 100mm
120mm extension shaft
Exchangeable tips Inc:
Blade, cross-head, hex,
and star-drive (Torx®)
Bonus Small magnifier.
Code STD6110



MICRO-DRIVERS KIT 33 PIECE

CHANGEABLE TIPS
Compact case includes
Deluxe soft grip 100mm
120mm extension shaft
150mm flexible shaft
Exchangeable tips Inc:
Blade, cross-head, hex,
and star-drive (Torx®).
Code STD6133



MICRO-DRIVERS KIT 27 PIECE

CHANGEABLE TIPS
Compact case
includes Deluxe soft
grip 120mm 105mm
extension shaft
and a flexible shaft
Exchangeable tips Inc:
Blade, cross-head,
hex, star-drive and
sockets.
Code STD5820



MICRO-DRIVERS RATCHET 12 PIECE

CHANGEABLE TIPS
Deluxe comfort grip.
Internal storage of tips.
Push-button open chamber
Includes 11 tips total
Blade, cross and star.
Ratchet head mechanism
Compact toolbox solution.
150mm total length.
Code STD6511





↓ Screwdrivers Micro

20 PIECE UNIVERSAL TOOL SET

ONE-DRIVER MULTI-BIT

Flat (blade) and nut drivers as well as hex keys and open wrenches in a case. Inserts into common handle (twist lock).

Blades: 1.5, 2.5, 3.5 mm
Cross: No.0, 1 & AWI
HEX: 1.5, 2.0, 2.5mm
Nut: 4.0, 4.5, 5.0, 5.5, 6.0 mm

Code
HT440



NUT DRIVER SET

5 piece nut driver Metric HEX Socket set

Sizes
3.0mm,
3.5mm,
4.0mm,
4.5mm,
5.0mm

Code
HT430



CERAMIC ALIGNMENT DRIVERS

ESD Safe Long-Life tips

Zirconium fine ceramic tips are durable, non-conductive, anti-static and anti-magnetic.

Description	Code
Phillips #0	DA88
0.4x2.4mm TIP	DA82
0.4x1.8mm TIP	HT418
0.4x1.3mm TIP	HT413
0.4x0.9mm TIP	HT409



TRIMMING ADJUSTMENT SET

10 PIECES

A set of ten piece hand tools 115mm Assorted tips for alignment & adjust
Made from ABS Non-inductive
Made in Taiwan

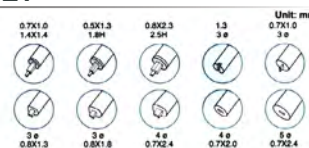

Code 1PKA001



LONG REACH SCREWDRIVER KIT

Consists of 3 Phillips head & 3 blade type screwdrivers. An extra long shaft allows you to reach difficult screws.

Code
HT535



ALIGNMENT SCREWDRIVER

Plastic body for insulation with a metal tip for extra strength. Ideal for alignment and adjustments.

Code
HT525

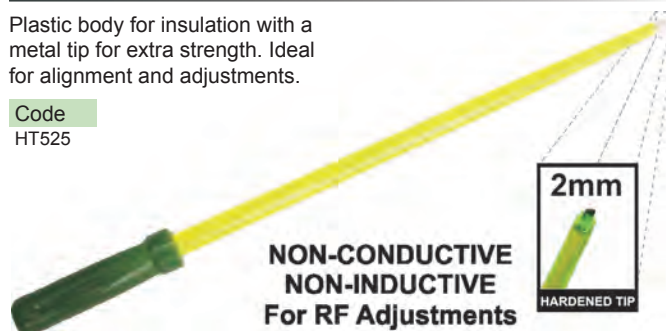

**NON-CONDUCTIVE
NON-INDUCTIVE
For RF Adjustments**



21 PIECE COMBINATION TOOL SET

METAL BODY JEWELLERS

5 SPANNERS: 4.0-6.0mm
5 NUT: 5.0-3.0mm
4 BLADE: 1.4-3.0mm
2 PHILLIPS: 0, 1
5 HEX: 3.0-5.0mm

Code
HT450



**21
JEWELERS
Metal**

MINI SECURITY DRIVER SET

Actually fabricated specifically for cellular phone servicing. Includes Phillips, Blade, Torx tamper proof drivers, and others for antenna release, etc. 8 drivers +more.

Code
HT880



TRI-WING MINI-DRIVER

3mm Mini Driver

Suit Nintendo-WII
Nokia and others.
Security driver
Professional grade
Made in Japan tool
Sunflag 17-C

Code
HT888





↓ Tweezers

TWEEZERS - STAINLESS STEEL

Surgical quality tools, Anti-acid, Anti-Magnetic, Non-serrated. Polished. Non-slip. Long Life. Won't distort. Premium grade. Force = Pressure at normal finger position to close (Approx.).

Length	Weight	Force	Code
138mm	30g	85g	HT940



Length	Weight	Force	Code
123mm	22g	150g	HT908



Length	Weight	Force	Code
120mm	18g	220g	HT903



Length	Weight	Force	Code
120mm	17g	100g	HT914



Length	Weight	Force	Code
115mm	16g	150g	HT906



Length	Weight	Force	Code
120mm	18g	260g	HT915



PEARL CATCHER PARTS PICKER

For removing small screws and other parts from hard to get at places. Spring loaded, all metal construction. Approx. 100mm long.

Code
PU5



CABLE TIE GUN

Tightens cable ties with trigger action. Then twist to cut-off excess cable tie end

Code
HT381



TWEEZERS - ANTISTATIC ESD

Poly carbonate non-twisting plastic Precision tweezers suitable for electrostatic electronics too. Chemical and heat resistant (+220C).

SHARP NOSE

Code
HTJ207



ROUND NOSE

Code
HTJ203



3MM NOSE

Code
HTJ205



7MM NOSE

Code
HTJ206



12MM NOSE

Code
HTJ202



SCISSOR CLAMP HEMOSTAT

MEDICAL GRADE INSTRUMENT
Clamps closed to hold firmly Locks in to closed position Stainless steel instrument 100mm long hand tool



SMOOTH JAWS

Code
HT32H

CABLE TIES

100 Pieces assorted Long/short, coloured and Stick-N-holds

Code
NCT500



VELCRO

More affixing and adhesive solutions including Velcro, Cable ties and more...

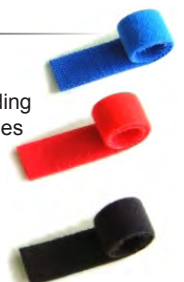

SEE SECTION 13 CABLE For More Cable Ties...



→ Hand Tools

ALLEN KEYS MINI-KIT

EXTENDED RANGE 0.7mm
Miniature keys not usually found in standard sized kits. These unique keys are required for guide posts, heads, motor pulleys, etc.
Kit includes 7 pieces
0.7, 0.9, 1.3, 1.5, 2.0, 2.5, 3.0mm.

Code
HV70



HEX KEY SET - METRIC

8X ALLEN KEY SET
8x steel allen keys
Metric value HEX
1.5, 2.0, 2.5, 3.0
3.5, 4, 5 and 6mm

Code
HT7542



HEX KEY SET - METRIC

7X FOLD-UP KIT
Metal handle with
7x steel allen keys
Metric value HEX
1.5, 2.0, 2.5, 3, 4,
5 and 6mm

Code
HT6371



HEX KEY SET - IMPERIAL

8X ALLEN KEY SET
8x steel allen keys
Imperial value HEX 1/16",
5/64", 1/8", 3/32", 5/32",
3/16", 7/32" and 1/4" Heat
treated long life

Code
HT7540



HEX KEY SET - IMPERIAL

9X FOLD-UP KIT
Metal handle with 8x steel
allen keys Imperial value
HEX Size 0.05" to 3/16"

Code
HT6292



↓ Miscellaneous

HAND ASSIST TOOLS

A collection of assorted hand tools
Scribes, hooks, blades, brushes, etc.
designed to assist technicians in repair
and servicing.

Code
SA10



MINI NEEDLE FILES SET

MINI FILE KIT
Five assorted 140mm different
tip profiles: Round, square, flat.
Insulated handles.
High tensile steel
Suit hobby work
Close & fine detail.

Code
NF140



MEDIUM NEEDLE FILES SET

6 PIECES 190mm
Excellent selection of
useful sizes & shapes.
Medium hand tool sized
Rubber grip handles
Medium/Fine grit files
Convenient storage case
Handles have hook holes

Code
HT2500



ENGINEER SCRIBER

HIGH-TENSILE STEEL
All metal hand tool for
scribing many surfaces
Sharpened point ends One
straight, other bent 175mm
total length Non-slip grip

Code
HT1824



VCR ALIGNMENT TOOLS

For adjusting audio/control heads,
tape guide path and other transport
mechanism parts. 3 types.

Code
HT36
HT87
HT89

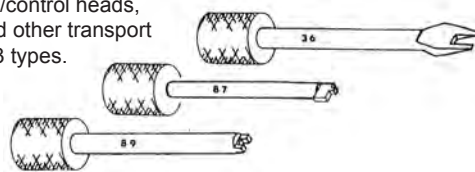

VIDEO HEAD EXTRACTOR

Adjustable to suit
many brands.

Code
HT800



VIDEO HEAD NOT INCLUDED

EXTRACT VIDEO HEADS
SAFELY AND ACCURATELY



→ Hand Tools

PLCC IC EXTRACTOR

For those delicate ICs with pins on all sides. This extractor first hooks under the diagonal corners then pulls upward evenly, removing the package without damage.



Code
CY850

IC TOOL SET ESD

Consists of three insertion tools and one extraction tool for static free handling of sensitive IC's

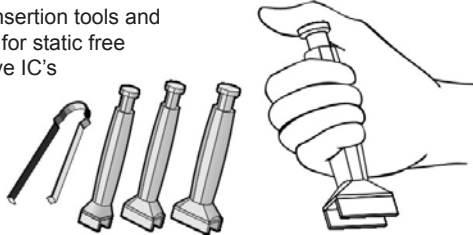

Code
ICT4

IC STRAIGHTENER ESD

Double sided for LSI and ICs. Bends vertical so pins align. Ground terminal.



ANTI-STATIC

Code
ICS01

WIRE-WRAP TOOL

WRAP/UNWRAP WIRE POST

Manual wire wrap hand tool
Old-school type electronics
Wraps 22-28AWG solid-core wire around square posts 0.017"
Offers a secure connection
Some prefer. No soldering.
Twist thumb-screw tool

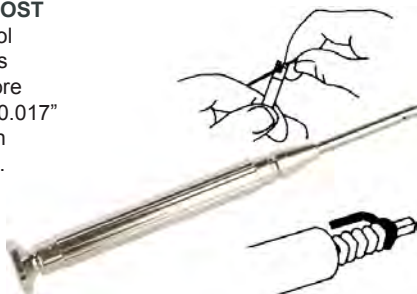

Code
HTWR1

FUSE REMOVER

Remove and insert fuses with ease. Compatible with most fuse sizes.

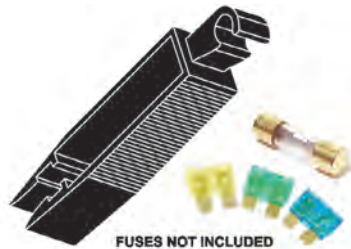

FUSES NOT INCLUDED

Code
FRT3



FUSE & RELAY REMOVER

10" COMPONENT GRIP

Box joint adjustable
9mm/35mm (Parallel) Grips components for safe and controlled extraction of items Excellent for tightly packed PCBs, etc.



Code
YF6254

↓ Tools Sets

ELECTRONIC TOOL WALLET

25 PIECE REPAIR KIT

An excellent variety of common electronic repair tools for the technician Soldering/De-Soldering, Screw drivers, Cutters, all manner of handy items. Zip-Case 285x195x50mm

Code
GTK030B



ELECTRONIC TOOL WALLET

12 PIECE REPAIR KIT

An excellent variety of common electronic repair tools for the technician Cross, Blade, Nut drivers IC Extractor, tweezers, etc. Great kit for Computer techs' Zip-Up case.

Code
GTK012



ELECTRONIC TOOL WALLET

23 PIECE REPAIR KIT

An excellent variety of common electronic repair tools for the technician Multi Tip driver w/ Torx IC Extractor, tweezers, Cutters, needle nose, etc. Handy little Zip-Up case.

Code
GTK026





14 TOOLS & TEST EQUIPMENT

14 TOOLS & TEST EQUIPMENT

↓ Crimpers

mm	0.71	0.99	1.07	1.10	1.19	1.72	1.90	1.98	2.54	3.25	3.50	3.85	4.52	4.75	5.41	6.50	6.65	7.06	8.10	8.23	8.90	9.12	10.9	12.06		
Inch	.028"	.039"	.042"	.043"	.047"	.068"	.075"	.078"	.100"	.128"	.137"	.151"	.178"	.187"	.213"	.255"	.262"	.278"	.320"	.324"	.350"	.360"	.429"	.475"		
HT336T1																										
HT336J																										
DL801V																										
DL801G																										
HT336A																										
HT336G4																										
HT336C2																										
HT336K																										
HT336D2																										
DL801K																										
DL801F																										
HT106H																										
HTH116M																										

HEAVY DUTY CRIMPING TOOL

RG178 RG179 RG180 RG187 RG316

Heavy duty construction and is designed to apply the correct amount of pressure so as to obtain a perfect result. Replaceable jaws.

Code
HT336T1



0.71mm (.028")
0.99mm (.039")
1.19mm (.047")
2.54mm (.100")
3.25mm (.128")
3.84mm (.151")

REPLACEMENT JAW

Code
JAW336T1

HEAVY DUTY CRIMPING TOOL

F N BNC UHF SMA & ST SC

Popular HEX Crimp ratchet From 1.07mm to 4.52mm HEX Suits coax and optic cable also "Beldin 8218" crimp Replaceable jaws.

Code
HT336J



1.07mm (.042")
1.72mm (.068")
1.98mm (.078")
3.25mm (.128")
3.85mm (.151")
CRIMP 4.52mm (.178")

REPLACEMENT JAW

Code
JAW336J

PROFESSIONAL CRIMPING TOOL

GENERAL PURPOSE CRIMP TOOL

Heavy Duty ratchet tool. Suits the more popular crimp PLUGS 5.4 & 6.5mm RG58U RG59U BNC TNC "F".

Code
HT336A

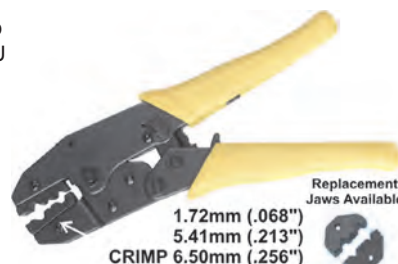

Replacement Jaws Available

1.72mm (.068")
5.41mm (.213")
CRIMP 6.50mm (.256")

REPLACEMENT JAW

Code
JAW336A

HEAVY DUTY CRIMPING TOOL

8.7" RATCHET CRIMPING TOOL

RG59, RG62 and RG174. Crimp sizes 1.07mm (.042"), 1.73mm (.068"), 4.52mm (.178"), 6.48mm (.255"), 7.06mm (.278").

Code
HT336G4



REPLACEMENT CRIMP JAW

Code
JAW336G4

RATCHET CRIMPING TOOL

RG174 SMA/SMB

Special SMA/SMB version Pin and Outer collar crimp 0.187 / 0.178 / 0.151 & 0.128" Shallow crimp for 0.068 & 0.042" 1.07, 1.72, 3.25, 3.50, 3.85mm 4.52 and 4.75mm HEX Crimp

Code
DL801V



REPLACEMENT JAW

Code
JAW801V

HEAVY DUTY CRIMPING TOOL

RG58 RG59 RG62 & RG6

Heavy duty construction tool designed to apply the correct amount of pressure so as to obtain a perfect result. Replaceable jaws.

Code
HT336C



1.72mm (.068")
5.41mm (.213")
6.50mm (.256")
8.10mm (.319")

REPLACEMENT JAW

Code
JAW336C

HEAVY DUTY CRIMPING TOOL

RG58, 59, 62, 140

Plus fibre-optic crimp tool!
Sizes 6.48mm (.255"), 5.41mm (.213"), 3.50mm (.137"), 2.54mm (.100"), 1.72mm (.068"), 1.10mm (.043")

Code
DL801G



6.48mm (.255")
5.41mm (.213")
3.50mm (.137")
2.54mm (.100")
1.72mm (.068")
1.10mm (.043")

REPLACEMENT JAW

Code
JAW801G

HEAVY DUTY CRIMPING TOOL

CATV "F" for RG59 and RG6

Heavy duty construction and is designed to apply the correct amount of pressure so as to obtain a perfect result. Replaceable jaws.

Code
HT336C2



1.72mm (.068")
6.65mm (.262")
8.23mm (.324")
9.14mm (.360")

REPLACEMENT JAW

Code
JAW336C2



HEAVY DUTY CRIMPING TOOL

RG58, 59, 62, RG8, 11, 213
Heavy duty construction and is designed to apply the correct amount of pressure so as to obtain a perfect result. Replaceable jaws.

Code
HT336D2



REPLACEMENT JAW
Code
JAW336D2



HEAVY DUTY CRIMPING TOOL

RG59 & RG6
HEX Crimp with 3 large sizes
Heavy duty construction tool correct amount of pressure to obtain a perfect result
8.90mm / 8.13mm / 6.48mm,
0.350" / 0.320" / 0.255"

Code
DL801F



REPLACEMENT JAW
Code
JAW801F



RG213 RATCHET CRIMPING TOOL

9" SUPER HEAVY DUTY
Pin and Outer collar crimp
0.075 / 0.100 / 0.128 / 0.425"
1.9mm / 2.54 / 3.25 / 10.9mm
Suit RG8, RG9, RG11,
RG174, RG316,
BLDEN9913

Code
DL801K



REPLACEMENT JAW
Code
JAW801K



HEAVY DUTY CRIMP

F6, F59, RG6, etc.
Our parts eg.; F322,
F325, P545 P541,
S521, etc. Strong
construction for these
larger cable crimping.
Easy double-action
lever, low fatigue.
HEX 1 8mm(0.322")
HEX 2 9mm(0.359")

Code
HT106H



**F59
F62
F6**



CRIMP TOOL EXTRA HEAVY DUTY

F N BNC TNC UHF SMA etc.
Professional Ratchet type.
2.54mm & 9.12mm & 12.06mm.
Suit RG F59, F6, F11 Cable.
Adjustable ratchet adjust.
225mm long. Double lever.

Code
HTH116M



**F59
F6
F11**



MULTI-PURPOSE CRIMPING TOOL

This combined multi-purpose tool will crimp non-solder type insulated terminals. Ideal for every tool box. Screw cutter, stripper, crimper all-in-one.

Code
OT400



Section 7

TERMINAL KIT
300 Pieces of Plug
Terminals (No tool)

Code
TMK300



MULTI-PURPOSE CRIMPING TOOL

PROFESSIONAL VERSION
This combined multi-purpose tool will crimp non-solder type insulated QD terminals. Heavy-duty, non-twist hand tool. Screw cutter, stripper, crimper all-in-one.

Code
HTS502



MULTI-PURPOSE CRIMPING TOOL

HEAVY-DUTY RATCHET TYPE
Applies the correct pressure for the perfect result

Code
HT301

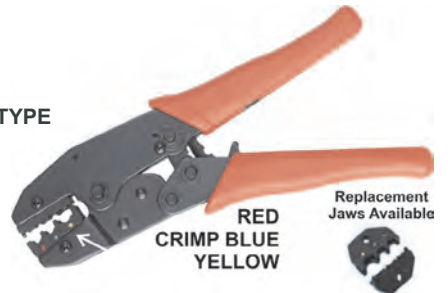

REPLACEABLE JAW TYPE
Code
HT236H

REPLACEMENT JAW
Code
JAW236H



INTERLOCKING SOLDERLESS CRIMP

QUICK DISCONNECT TYPE
Non-insulated terminals
This tool Curl-Crimps for use with Split-Crimp ends
AWG20-18, AWG16-14,
AWG12-10

Code
HT236C



REPLACEMENT JAW
Code
JAW236C

MICRO CONNECTOR CRIMP

CURL-CRIMP NON-INSULATED
Suits Non-Insulated terminals Curl Crimp 1.25mm to 2.5mm pitch connectors & pins. AWG32 to AWG20 Cable. Comfortable soft handle oil-resistant elastomer (TPR) Coiled spring jaws with locking latch. Length 175mm Made in Japan

Code
PA09





↓ Crimpers

COMPRESSION CRIMP TOOL "F"

20.3mm SUIT "F" ONLY
 eg. F333 & F334 plugs.
 See Plugs Section 7
PLUGS & SOCKETS
 ie. "F" Types ONLY.
 RG59 & RG6 Cables
 Suit Dual, Triple or Quad
 shielded coax. Compress
 distance 20.3mm +/-0.15mm
 All metal tool Easy action.



Code
 HTH518A

COMPRESSION CRIMP TOOL

UNIVERSAL F/BNC/RCA
 Quick adaptor change for
 different plugs See Plugs
 Section 7 **PLUGS & SOCKETS**
 RG59 & RG6 Cables Suit Dual,
 Triple or Quad shielded coax.
 Compress distance is Trim
 adjustable (locks) All metal
 hand tool Easy action.



Code
 HT509

COMPRESSION CRIMP TOOL

PROFESSIONAL UNIVERSAL
 Fully adjustable with
 adaptors for crimping
 any of the plugs in our
 range (Section 7 **PLUGS**
 & **SOCKETS**). Adjustable
 crimp length. Professional
 quality. Tension adjustable.
 Suit Dual, Triple or Quad
 shielded coax.



Code
 HTH510B

COMPRESSION CRIMP KIT

RG6 PLUG TOOL CASE

This kit includes three tools for custom building cables for cable TV, satellite, communication equipment. Heavy duty tools for reliable service. Round cable cutter for coax cable. Universal stripping tool for cutting, and trimming to correct portions. Adjustable for assorted coax cables. Compression plug crimping tool. Kit includes 6 RG6 "F" crimp plugs. Suits RG7, RG11, RG59, RG6 & QUAD

Code
 HT6923



F CONNECTOR INSTALLATION TOOL

CABLE ASSIST

One end to enlarge space
 between shield and
 insulation for RG59, the
 other RG6. Another end to
 lock "F" connector allows
 hold so as to assemble



Code
 HT224D

TELEPHONE CRIMPING TOOL

Professional crimping tool.
 All metal construction with
 stripping blades & spring
 load lever action.

4 PIN SMALL 7.5mm

Code
 OT245

**CRIMP PLUGS - Section 7
 PLUGS & SOCKETS**



MODULAR CRIMPING TOOL

Professional crimping tool.
 All metal construction with
 stripping blades & spring
 load lever action.

6 & 4 PIN STANDARD

Code
 OT250

8 PIN RJ45

Code
 OT256

**CRIMP PLUGS - Section 7
 PLUGS & SOCKETS**



MODULAR CRIMPING TOOL

DUAL CHAMBER 6P/8P

Professional crimping
 Single lever action All metal
 construction with stripping
 blades & spring load lever
 action. RJ45 RJ11 RJ12 6P/8P

Code
 OT258

**CRIMP PLUGS - Section 7
 PLUGS & SOCKETS**

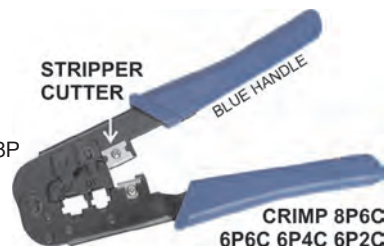

MODULAR CRIMPING TOOL ALL-IN-ONE

PROFESSIONAL DESIGN

Low fatigue hand grip
 Wire stripper & cutter
 Premium quality tool
 Suit RJ45 RJ11 RJ12,
 4, 6, 8 pin.

Code
 HT345RA

**CRIMP PLUGS - Section 7
 PLUGS & SOCKETS**



MODULAR CRIMPING TOOL ALL-IN-ONE

HEAVY-DUTY DESIGN

All metal RATCHET tool
 Professional lever action
 Low fatigue hand grip
 Single action stripper
 Cut & strip to length
 6mm / 12mm UTP / STP
 Premium quality tool
 Three crimp chambers

4P/6P/8P/10P

Code
 DL3460R





↓ Strippers

WIRE STRIPPER DELUXE

SELF-ADJUSTING

Heavy duty Crescent brand
Used for stripping wire &
Crimping Insulated and
non-insulated terminals
Cuts & strips in 1 action
24-10AWG (0.5-6mmØ)

Code
CWS1



GAUGE WIRE STRIPPER

SINGLE ACTION AUTO

Several Gauge slots Insert cable into
correct slot and squeeze the handle.

24-12AWG [0.5-2.0mm]

Code
KUS4A



20-8AWG [1.0-3.2mm]

Code
KUS4

WIRE STRIPPER & CUTTER

SINGLE ACTION AUTO

Suit cable 0.5-6.0mm Grips
and strips in one hand grip
press Adjustable pressure.
Adjustable cable stop Suit bell
wire, CAT5 Telephone, etc..

Code
GTA002



UNIVERSAL CABLE STRIPPER

Patented device for stripping
the covers off todays modern
cable styles, eg. STP/UTP
4P/6P/8P Speaker, Coax, etc.

Code
HTS501A



COAXIAL CABLE STRIPPERS

Suits most crimp plugs
Adjustable blade depth
Suits RG6 (5C2V)
RG58 (3C2V)
RG59 (4C2V)

Code
HT377

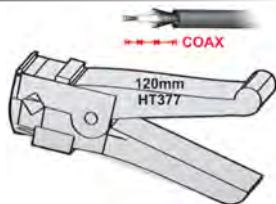

COAXIAL CABLE STRIPPERS

Suits most crimp plugs
Adjustable blade depth
Suits RG6 (5C2V)
RG58 (3C2V)
RG59 (4C2V)

Code
HT332



COAXIAL CABLE STRIPPERS

Suits most crimp plugs
Adjustable blade depth
Suits RG6 (5C2V)
RG58 (3C2V)
RG59 (4C2V)

Code
HT-322



↓ IDC Punch-Down

IDC TOOL

Disposable type
tool for IDC cable
insertion. Quick n'
easy saves time!

Code
HT-IDC1



IDC PUNCH DOWN TOOL - PROFESSIONAL

Crimps and clips in
one action. Compatible
with the standard
"Krone®" type. Quality
constructed.

Code
HT-IDC2



↓ Miscellaneous

RETRACTABLE KNIFE MINI BOX CUTTER

PLASTIC BODY 140mm

Lockable pocket size With Snap Off Blades

Code
HT310

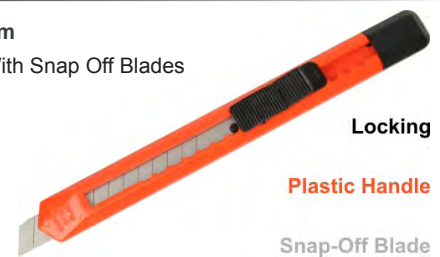

Locking

Plastic Handle

Snap-Off Blade

RETRACTABLE KNIFE BOX CUTTER

Zinc alloy Metal body.
Retractable blade locks
Blade storage in handle
Hand comfort 140mm long

Code
HT8003

10 PACK OF BLADES

Common trapezoid blades
Order one to receive 10

Code
HT8066



x10

GYPROCK SAW

SMALL HAND SAW

Made in Japan with 2 blades.
Each blade has two faces of
differing gauge teeth for Metal
or Wood. Retractable. Tipped
sharp for piercing. Blade one
is cut Away (Push) Other blade
is Cut Toward (Pull)

Code
HT300



PULL BLADE

Code
BLD301

PUSH BLADE

Code
BLD302



↓ Saws

CONDUIT SAW 12"

PVC, WOOD & METAL

Suitable for cutting most materials including wood, metals, plastic, laminates and plaster. The handle is easy to hold and adjusts to 9 positions for sawing in confined spaces. The blade is hardened and tempered for long life and is coated in polyester, reducing friction for faster sawing action.

Code
CSC12



HACKSAW CLOSE-QUARTER

12" BLADE HANDLE

Metal handle holds a 300mm hacksaw blade for close-quarter work

Code
HT7963



300mm REPLACEMENT BLADE

24tpi Bi-HSSE-Cobalt Germany*
Suit metals, alloys, plastics.

Code
FH1224



*Supply may vary. Same specifications

HACKSAW DELUXE FULL SIZE

12" BLADE SOFT-GRIP

Metal handle locks blade
90° or 45° cutting angle

Code
HT2103



300mm REPLACEMENT BLADE

24tpi Bi-HSSE-Cobalt Germany*
Suit metals, alloys, plastics.

Code
FH1224



*Supply may vary. Same specifications.

HACKSAW MINI SIZE

6" BLADE SOFT-GRIP

Professional hand tool Metal handle
locks blade 360° at any cutting angle

Code
H2107

150mm BLADES X10

32tpi High-Carbon Steel for
Soft metals, alloys, plastics

Code
FT0632

*Supply may vary. Same specifications.



CONDUIT CUTTER

PVC PIPE CUTTER 42mmØ

Double action lever action.
Heat treated cutting blade.
Cuts cleanly No burring reg.
Heavy duty design & made.
Cuts plastic hose or pipe up
to maximum 42mm

Code
CCC42



↓ Cutters

MICRO NIPPERS 115mm JAPAN

Extra small cutters
Premium grade S58C
Optimum designed for
electronic applications.
With insulated handles
and spring return.
Copper 1.0mmØ
Strand 1.6mmØ

MICRO NIPPER JAPAN

Size Code
115mm NS04

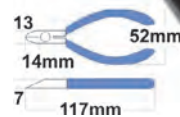

MICRO NIPPERS 115mm TAIWAN

MICRO NIPPER TAIWAN

Premium grade tools
Optimum designed for
electronic applications.
With insulated handles
and spring return.

Size Code
115mm HT205

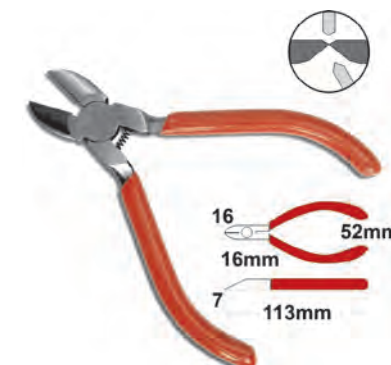
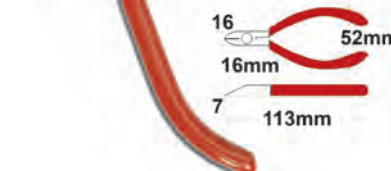

CUTTING NIPPERS 125mm JAPAN

NIPPER JAPAN

Premium grade tools
Optimum designed for
electronic applications.
With insulated handles
and spring return.

Size Code
125mm NS03

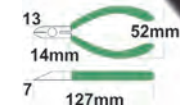

CUTTING NIPPERS 125mm TAIWAN

MICRO NIPPER TAIWAN

Excellent General purpose
electronics and hobbyist
cutting nippers. Taiwan.
With insulated handles
and spring return.

Size Code
125mm HT109

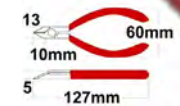

CUTTING NIPPERS 125mm CHINA

MICRO NIPPER CHINA

Excellent General purpose
electronics and hobbyist
cutting nippers. Economy.
With insulated handles
and spring return.

Size Code
125mm HT206

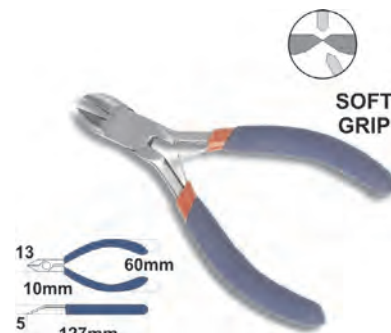
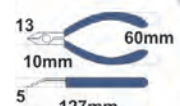



↓ Cutters

MICRO NIPPERS 115mm SWISS

Professional Cutters

Made in Switzerland by EremTM for Precision and long life. 115mm Soft Grip Small oval head Full-flush action. The Best available.

Size	Code
115mm	HT522N

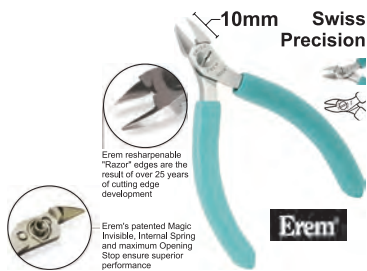

FLUSH CUTTERS 125mm

MICRO-SHEAR 170

Superior high quality cutters with flush scissor action for low fatigue and a close flush cut. Spring return. Brand supplied may change. Scope, Edsyn, Plato, etc.

Size	Code
125mm	HT170



SAFETY CUTTERS 125mm XURON

MICRO-SHEAR 170-II

Premium grade tool cutter with flush scissor action for low fatigue and a close flush cut. Spring return. Safety wire catch. Made in USA

WITH CATCHER

Size	Code
125mm	HT1175



SAFETY CUTTERS 125mm XURON

MICRO-SHEAR 9200

Durable Alloy Steel Super heavy duty Micro-Shear cutters with lead retainer. Low fatigue cutting with ultra-durability. Soft non-slip grip. Cut 14AWG copper Length 125mm Blade 9mm

Size	Code
125mm	HT9200



MICRO-NIPPERS 125mm XURON

USA MADE 170-II

Micro-Shear® US Pat 3774301 "Blade by-pass Shear cutting". Xuro-rubber grip. Drop forged and computer cut. Cut 20AWG copper Length 130mm Blade 9mm

Size	Code
125mm	HT1702



FLUSH CUTTER 150mm SCOPE

HEAVY DUTY 2178

Extra-Hardened Machined Tempered Steel Cutters Long life blades for larger cable work. Spring return lever Large cushion grip Premium grade tool Long life. Sure action.

Wire 1.5mmØ

Size	Code
150mm	HT178



FLUSH CUTTER 150mm XURON

MAXI-SHEAR HEAVY-DUTY 2175

Tough shear action cutter for general electronic applications like cutting Harnesses & cables, etc. Xuro-rubber grip handles. Low fatigue design for longer working use. Cut 14AWG copper

Length 150mm

Blade 12mm

Size	Code
150mm	HT2175



WIRE CUTTERS 150mm JAPAN

CUTTING NIPPER JAPAN

Extra strong cutters Premium grade S55C Extra hardness HRC 58±4 Cuts steel wire to 2mmØ Sharp and durable cutting for precision wiring work

Size	Code
150mm	NK16



HEAVY DUTY DIAGONAL CUTTERS 200mm

CRESCENT USA 10"

Large cutters for heavy cutting of cable, etc. High leverage design. Long 20mm jaws. Hardened/Toughened. Made in the USA by Crescent/Cooper-Tools. Insulated handles.

Size	Code
200mm	HT5428



HEAVY DUTY CABLE CUTTERS 240mm

T&E 10"

Large cutters for heavy cutting of cable, etc. High leverage design. Hooked 30mm jaws. Hardened/Toughened. Insulated handles.

Size	Code
240mm	HT338





↓ Pliers

CUTTER AND PLIER KIT

Premium Grade Xcelite® (USA) from Cooper Tools. Superior high quality hand tools reduce fatigue with sharp strong action and comfortable grip. Save by purchasing both together!

170M Shear Cutter 125mm
Tweezer nose Plier 150mm

Code
HT1300



NEEDLE NOSE PLIERS 125mm JAPAN

Premium tool designed for electronic applications Insulated handle Non-slip grip Serrated teeth Cutting nipper

Size Code
125mm HT305



LONG NOSE PLIERS 150mm JAPAN

Premium tool designed for electronic applications Insulated handle Non-slip grip. Serrated teeth Cutting nipper. Heavy duty

Size Code
150mm HT306



PLIERS GENERAL PURPOSE 115mm

MINI BULL NOSE PLIERS

Hobby & electronic use. Hardened steel polished Serrated multi-grip teeth tip and nut grab pliers. Double molded handles. Non-slip soft grips. Wire cutting blades. Spring return.

Size Code
117mm HT213



PLIERS GENERAL PURPOSE 160mm

DOUBLE MOLD HEAVY DUTY

Hobby "Bull Nose" Pliers Hardened steel polished Serrated multi-grip teeth tip and nut grab pliers. Double molded handles. Non-slip soft grips. Wire cutting blades. Excellent value

Size Code
160mm HT215



TWEezer NOSE PLIER 150mm SCOPE

Long narrow reach. Serrated jaws are Strengthened to resist crossover. Spring return. Cushion grip. Light in weight, strong in quality. Premium grade Professional tool.

Size Code
150mm HT378



PLIERS GENERAL PURPOSE 205mm

8" GRIP/CUT INSULATED

Large "Bull Nose" Pliers Drop-forged vanadium steel Serrated multi-grip teeth tip and nut grab pliers. Double molded handles. 1000V Insulated. Non-slip soft grips. Wire cutting blades. Excellent value.

Size Code
205mm HVEP205B



TWEezer NOSE PLIERS XURON

SMOOTH JAW TYPE

Precision, ergonomic, durable hand tool. Strong carbon steel extra thin profile. Length 129mm Nose 20mm

Size Code
129mm HT485

SERRATED JAW TYPE

Size Code
129mm HT486



TWEezer NOSE PLIER 115mm JAPAN

Flat 1mm Tip with spring return. Premium tool designed for electronic applications Insulated handle. No serration (flat).

Size Code
115mm PS04



NUT REMOVER PLIERS

REMOVE DAMAGED SCREWS!

This unique plier will grip with its elaborate vertical & horizontal serrated jaw and remove Engineer Japan

Length Code
150mm PZ55
175mm PZ56





↓ Miscellaneous

ADJUSTABLE WRENCH 6"

20MM SPANNER

High-Carbon Steel Precision tool.
Doped soft grip. Adjustable to 20mm.
150mm long compact.

Code
STP710



MADE IN TAIWAN

ADJUSTABLE WRENCH 8"

STANDARD SIZED 30mm

The jaw is adjustable 30mm
Drop forged chromium steel
Rust resistant chrome finish
Thumb screw for adjustment
Total length is 205mm (8")
Comfort "Grip-Well" handle

Code
HT17187



PANAUISE JR

A THIRD HAND!

Workbench assistant.
Made in the USA.
Kg Cast Iron base.
Reinforced fibre plastic fingers
Jaws open 73mm.
Ball joint lock pivots & rotates
Base bolts down "A helping hand"

Code
PV201



CLAW HAMMER

14" 20oz

Extra-strengthened.
Carbon steel head
drop-forged with
Poly-fibre mast.
Rubber grip handle
345mm total length
560g (½Kg) weight
Extra long life
Minimal vibration
With hook hole.

Code
PAO5000



CLAW HAMMER STUBBY

6" 10oz

Short handle hammer Solves
awkward nails Magnetic head
holds nail initially too! Extra-
strengthened Carbon steel head
drop-forged with Rubber grip
handle 155mm total length 280g
(¼Kg) weight

Code
PAO5308



155mm

NIBBLING TOOL

PUNCH CUTTER

Cuts up to 18AWG ~1.2mm
soft steel and aluminium, etc.
Drill a 9.5mm hole Insert head
and squeeze handles
5mm Square punch.

Code
HT204



RATCHET GUN

CAULKING GUN

Standard friction type
Dripless. All metal. 5:1
thrust ratio. Smooth ratchet
Suit standard ~8" Caulking
cartridges

Code
HT816



POP-RIVET GUN

4 RIVET NOZZLES

Kit comprises hand tool
260mm suit 4 sizes
and bonus 60 piece kit
of various sized rivets

Code
PA26448

POP-RIVETS

3.0x9.5mm Rivets
Receive 100 pieces

Code
SCPR1





→ Miscellaneous

MIGHTY-MARKER INK PEN

PERMANENT MARKER

Pen for Indoor or outdoor use Permanent water-proof quick dry Xylene-free, alcohol based ink works on metal & most surfaces highly visible, fade resistant Patented valve controlled tip This pen will never dry up! Manufactured in the USA

Colour	Code
Black	IM17BK
Blue	IM17BU
Green	IM17GN
Red	IM17RD

SPECIFICATIONS

Valve tip protects contents
To re-ink, press tip down.
Stroke width: 1.6mm
bullet. Metal barrel
contents 13ml

NOTE: Industrial use only
Not for use with children



INK MARKER



**...LEFT THE LID OPEN?? NO WORRIES!
WITH ITS UNIQUE "VALVE TECHNOLOGY",
IT WILL NEVER DRY UP!!!**

MIGHTY-MARKER PAINT PEN

CABLE PAINT MARKER

Pen for Indoor or outdoor use Paints on metal & most surfaces Permanent water-proof quick dry Highly visible bright colours Oil based liquid paint opaque Fade and abrasions resistant Patented valve controlled tip Manufactured in the USA

Colour	Code
Black	PM16BK
Blue	PM16BU
White	PM16WH
Yellow	PM16YL
Gold	PM16GD
Green	PM16GN
Purple	PM16PU
Red	PM16RD
Silver	PM16SL

SPECIFICATIONS

Valve tip protects contents
To re-ink, press tip down.
Stroke width: 2.3mm
bullet. Metal barrel
contents 10ml



CABLE PAINT MARKER



**...LEFT THE LID OPEN?? NO WORRIES!
WITH ITS UNIQUE "VALVE TECHNOLOGY",
IT WILL NEVER DRY UP!!!**

→ Safety Equipment

RIGGER GLOVES PIG GRAIN

Leather safety gloves
Comfort & protection Front
and back glove Beige in
colour Large universal size.
Supplied in pairs.

Code
PPGL-PIG



RIGGER GLOVES COW GRAIN

Leather safety gloves
Comfort & protection Front
and back glove Grey in
colour Large universal size.
Supplied in pairs.

Code
PCGL-COW



GLOVES GENERAL PURPOSE COTTON

100% COTTON SOFT
Stretch comfortable. Protect
hands and equipment from
finger prints, etc. Re-usable,
cleanable. One size fits all!
Supplied in pairs.

Code
GLV2



GLOVES ESD REUSABLE NYLON

STATIC DISSIPATIVE COATED
Elastic wrist cuffs Palm and finger
coated with antistatic urethane for
a non-slip grip.

Size	Code
Small	GLV2ESDS
Medium	GLV2ESDM
Large	GLV2ESDL



EASY GRIP

GLOVES ESD DISPOSABLE

100% NITRILE "SAFE"
Powder free Nitrile examination gloves.
Special formula without allergens,
silicone, etc. (1V). BSEN455:2000
ISO9002.EN46002. Hypersensitive feel.
50 pairs supplied in a dispenser box.

Size	Code
Small	GLV100S
Medium	GLV100M
Large	GLV100L





→ Safety Equipment

EAR PLUGS

FOAM EARPLUGS

Super comfortable malleable foam 3x separate pairs in sealed bags

Code
ABA106



RE-USABLE CORDED

2 Pairs of reusable earplugs Washable & comfortable to use Orange with soft nylon cord

Code
ABA102

PASSIVE EARMUFFS

REAR METAL BAND

Designed to fit comfortably while wearing a safety helmet the band fits behind the neck. Quality made light-weight Weather resistant long-life Soft cushion full earpads Bright yellow and black.

Code
ABA101



NOISE CANCELLING EARMUFFS

ACTIVE EAR PROTECTION

Inbuilt electronics actively reduce noise levels over 85dB! Excellent noise fatigue reduction improvement Sound Level Conversion SLC80 Class 1 AS/NZS 1270:2002 Noise reduction ear protection Requires 2x "AA"

Code
ABA268



MULTIMEDIA EARMUFFS

Noise reduction ear protection With built in AM/FM Stereo Radio Requires 2x "AA" Batteries

3.5mm input

Listen to iPods®, MP3, etc.

Code
ABA330S

USB READER

Listen to MP3 Flash Drive

Code
ABA858

BLUETOOTH

Answer your mobile phone

Code
ABA830



*Style may differ to illustration.

AM/FM WORKSITE RADIO W/ AUX

SUPER RUGGED IP66

Water resistant & Tough AM/FM Radio. Backlit digital dial plus bonus LED torch. Water resistant unit with protective storage compartment & 3.5mm Aux Input for iPods® Loud 5" 15W output. USB port for charging. 8x "C" Batteries or 240Vac. Tough stuff.

Code
ABA86WR



VENTED HARD HAT

SAFETY HELMET

6 Point Harness. Adjustable strap. Light in weight. Plastic Hard Hat Ventilation holes. One size fits all. Available in High visibility Colours:

Colour	Code
White	PHHV-WH
Yellow	PHHV-YL
Flouro	PHHV-FY



SAFETY GLASSES

CLEAR GOGGLES

Protecting your eyes is most important! All clear plastic Non-scratch poly. Folds for storage fits over spectacles One size fits all.

Code
HT7331



VISITOR GOGGLES CLEAR

Protect your eyes Inside or outside. Comfortable wear Hinged glasses. Light weight. They are worn over prescription glasses or by themselves. Free of distortion. Medium impact anti-scratch Clear lens.

Code
WWP3000



SAFETY GOGGLES CLEAR

Protect your eyes Inside or outside. Attractive styled Hinged glasses. Tsunami. Safety Specifications AS/NZS 1337 LIC 2144. Medium impact anti-scratch 99.9% UVP

Code
WWP1600



SAFETY GOGGLES TINTED

Protect your eyes Inside or outside. Attractive styled Hinged glasses. Tsunami. Safety Specifications AS/NZS 1337 LIC 2144. Medium impact anti-scratch 99.9% UVP

Code
WWP1620





↓ Cable Puller

PUSH-PULL RODS [CMS]

Run Cable in Ceilings and Walls Easily with this Fibreglass Rod System. Collapsible for easy portability. Premium quality professional.

- * Fibreglass rods with thick polypropylene coating attach together by screw thread. Dismantle for easy storage & transportation.
- * Ideal for running multi-purpose cable behind walls, up through crawl spaces and under floors Perfect for every hard to reach place.
- * Non metal/non-conductive bright yellow polypropylene coated rods protect delicate wires and to protect user from lethal wires.
- * Faster and easier than old fashioned electrical fish for running cable, now you can push or pull cable inside or outside of conduit.
- * Easily connected rods offer controlled flexibility of length required for each application.
- * Supplied WITHOUT TIPS (Sold Separately) or Purchase as a Kit with Bonus Carry Bag.

These 6mm diameter flexible rods are made of non conductive fibreglass with a polypropylene coating, and are flexible enough to go around corners and up and down walls through small openings, yet are strong enough to withstand virtually any test you may out them to. Each length is fitted with threaded attachments at each end. Connect as few or as many rods together as needed to attain whatever length necessary. CMS Push Pull Rods are sold as a set of 4 x 1.5mtr rods These rods replace the old fashioned electrical fish formerly used for running and retrieving cable. Push Pull Rods are equally useful to push or pull cable inside or outside conduit. Requires hooks listed below...

Set of 4 Push-Pull Rods

Code
PPP6



Set of 4 x 1.5mtr rods. Requires Tips. See below... or as a kit. See PPK8 Below...

Push-Pull Rods and Selected Accessories Kit

Includes set of 4 x Push Pull Rods, 1 x Grabit Hook, 1 x Standard hook, 1 x Magnet Locator (Rare Earth), 1 x Pulling Eye, and 1 x Convenient Carry Bag.

Code
PPK8



PUSH-PULL RODS [CMS] ACCESSORIES

PPG6 Grabit Hook

The Grabit hook is self-directional with a floating head which seeks out the target wires and pulls them together for easy retrieval. The serrated hook face pursues, grabs and holds inaccessible loose wires.

Code
PPG6

PPM6 Magnet L oicator

When you need serious pull, get the magnet locator, so strong it even picks up tools!

Code
PPM6

PPE6 Pulling Eye

Code
PPE6

PPH6 Standard Hook

Code
PPH6

PPB6 Bullet Tip

Code
PPB6

PPF6 Pulling Eye

with 75mm Flexible Extension

Code
PPF6

PPA6 Hook Wire (All purpose)

The 'Hook Wire' seeks out the target wires and pulls them together for easy retrieval. The serrated hook face & curved nose pursues, grabs and holds inaccessible loose wires.

Code
PPA6

PPU6 Universal Tip

This product is to be used when pulling cables (such as fibre) that you would like to spin or rotate in conduit or ceilings. It should often be used with the Pulling Sock (PPS6), The Whisk (PPW6) or the Pulling Eye (PPE6). Rotates 360 degrees so wires can spin while being pulled.

Code
PPU6

PPFM Magnet with 75mm Flexible Extension

Code
PPFM

PPC6 Carry Bag

Strong yellow nylon.

Code
PPC6

PPL LED Light Tip

LED Light Tip is a torch that broadcasts a strong light to guide users to the correct position in dark areas. It eliminates the need for glow rods. Supplied with a small replaceable battery, the 1/2 inch diameter LED lights up when screwed to tip.

Code
PPL

PPR6 Replacement Tip Kit

Spare parts for repairing broken end tips to the fibre-glass rods. Includes 1x male 1x female + glue

Code
PPR6

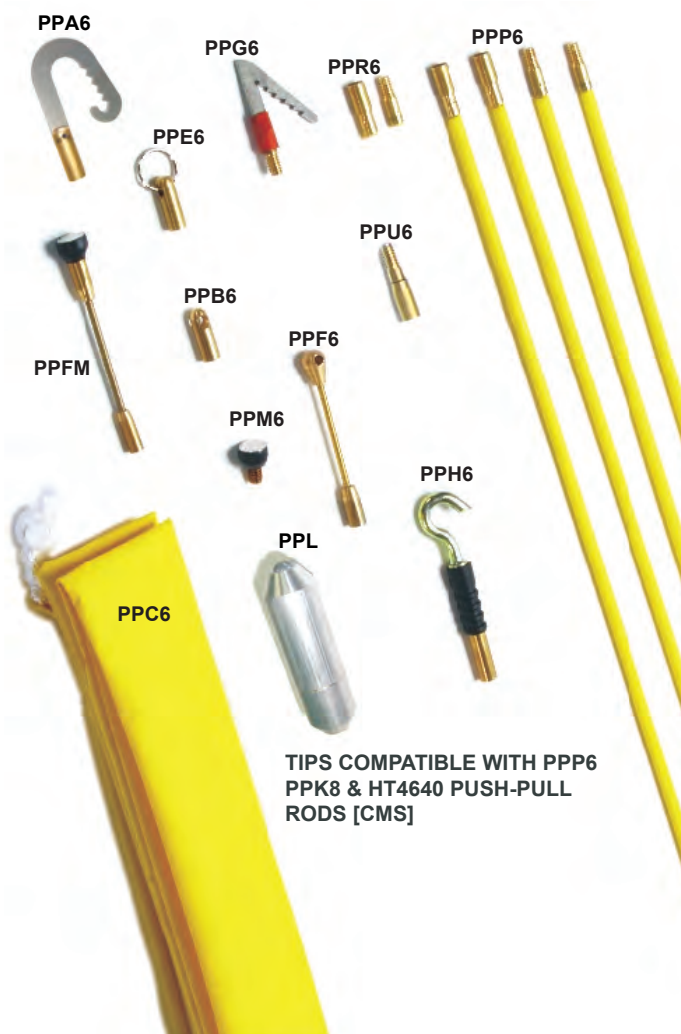

TIPS COMPATIBLE WITH PPP6 PPK8 & HT4640 PUSH-PULL RODS [CMS]



↓ Cable Puller

TELESCOPING PULLING POLE [CMS]

4.8mtrs fully extended but only 0.6mtr long collapsed - Includes 1x Hook - More Available*

EXTENDS TO 4.8 METRES

For use in long spans and in hard to reach areas in ceilings, under floors and crawl spaces. Ideal for use when running cable across suspended ceilings. Extends from 0.6M out to 4.8M and is fitted with a unique flexible hook end which is suitable for gripping the outer cable sheath securely. Constructed from lightweight non-conductive fibreglass material. Overall weight is just 2Kgs!

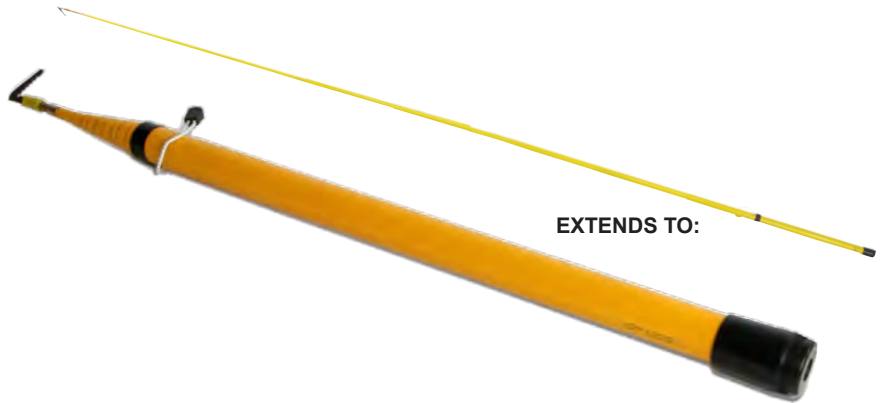

EXTENDS TO:

Code
HT4640

10M CABLE PULLER KIT

10 x 1M FIBREGLASS RODS

Easily connected rods offer controlled flexibility of length required for each application. Kit contains :- 10 (1000mm) rods(Φ5mm). 1 pulling eye(36mm). 1 standard hook (65mm). 1 flexible extension(190mm).

Code
PPK13



Note :- Accessories/Rods not available separately.
This kit is not compatible with other push/pull kits.

CABLE PULLER

20M COIL TYPE

Professional quality Steel Coil/spring. Allows push & pull. Metal aglet ends. Suit electricians, installers, etc. Ideal for pulling cables through walls ceilings & roof runs.



Length Code
20 Metres PTS20M

FISH TAPE 30M

SINGLE FIBRE GLASS

Large reel professional 2/3rd tube storage Non-conductive safety Single 5.6mm diameter Smooth movement cable High 250Kg capacity "Rattle-Snake" leader

Code FTP30



FISH TAPE REEL

15M FIBRE GLASS

Professional grade tool non-scraps Fibreglass cord 280Kg load, 330Kg break. Windup reel saves tangle Non-conductive safety 5.2mmØ Oblong shape easy control smooth coat "Rattle-Snake" leader metal spring aglet. Fluorescent coloured. for easy viewing OPT Taiwan

Case 300mmØ
Length 15 Metres
Code FTP15



FISH TAPE 50M

TRIPLE FIBRE GLASS

Large reel professional 2/3rd tube storage 660mmØ Non-conductive safety High visibility orange and black contrasted. Three composite cables forms one super strength 7mm diameter cord with High 500Kg capacity "Rattle-Snake" leader, metal aglets OPT Taiwan quality.

Length 50 Metres
Code FTP50





→ Storage Boxes

TACKLE BOX COMPONENT TRAY (04)

7 COMPARTMENTS

175x145x35mm
Plastic tray storage bin for holding small items.

Code
PSC1003



TACKLE BOX COMPONENT TRAY (04)

17 COMPARTMENTS

275x180x40mm
Plastic tray storage bin for holding small items.

Code
PSC1005



TACKLE BOX COMPONENT TRAY (04)

32 COMPARTMENTS

290x220x75mm
Double sided.
With removable walls.
2 Lids. Carry handle.

Code
PSC1006

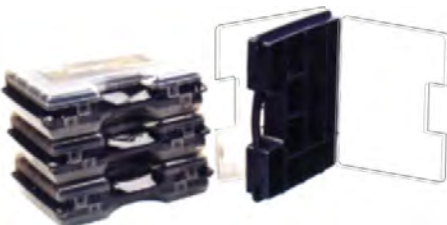

SCREW KIT

1400 SCREWS IN A CASE

14 Styles popular types
Button, Pan, Bugle heads
Attache case included

Code
SCR14

SCREW RANGE

A selection of Screws
Available See the last few pages, this section



TOOL BOX

19" WITH TRAY

480x230x210mm Plastic. Lockable. Internal tray is removable. Suit compact power drills, hammers, most hand tools. Water corrosion resistant box.

Code
TC1007



MINI-ATTACHE TOOL CASE

SOFT SIDED TEAR-PROOF VINYL

Size: 400 x 300 x 60mm

Elastic tool grips, large & small. For screw drivers, hand tools, etc. Inside pockets and removable pallet. Heavy duty construction & zippers. Black and Dark green in colour. Reinforced edges and stitching. Plastic perimeter for strength. Comfortable Briefcase handle. Includes optional carry strap.

Code
AT963



TOOLS NOT INCLUDED

ATTACHE TOOL CASE

Tough aluminium case. Professional type like photographers, etc. Black with silver knock panels & edges. Removable dividers. Adjustable dividers. Suits meters, etc. Removable lid pouch that suits hand tools. 458 x 300 x 140mm

Code
AT458



Jiffy Boxes

COMPACT PLASTIC CASES

Comprehensive range of project boxes from the genuine manufacturer for optimum quality and reliability with a premium finish.

See Section 02





→ Measurement Tools

TAPE MEASURES

LOCKING METAL TAPE

Drop resistant design Belt clip & Hand strap Dampened retraction Left/Right handed Hold buttons and a Locking button

Length	Code
3M	HT6940
5M	HT6941
8M	HT6942



12" STEEL RULE

300mm STAINLESS

Premium stainless steel Markings in Imperial & Metric on the flip-side

Code
HT6991



MULTI-SQUARE & LEVEL

8" ADJUSTABLE ANGLE

180mm stainless steel rule Rule is Metric & Imperial Adjustable protractor angle head with wing-nut locking and three spirit levels 0°/45°/90

Code
MO10



COMBINATION SQUARE & LEVEL

12" ALL METAL WITH 45°

300mm metal rule with slide Accurate 45° and 90° angles Spirit level built-in Suit metal & wood work Excellent mitre joints, etc. Adjustable slide with lock All metal quality made for long life and accuracy Professional tool Rule is Metric & Imperial.

Code
MO12



ELECTRONIC CALIPERS

STAINLESS STEEL

Precision electronic Measurement instrument 0.01mm to 155.00mm LED Display shows metric or imperial Thumb guide adjust Tension adjuster Internal / External and Step-Depth. Plastic storage case.

Code
CLP111

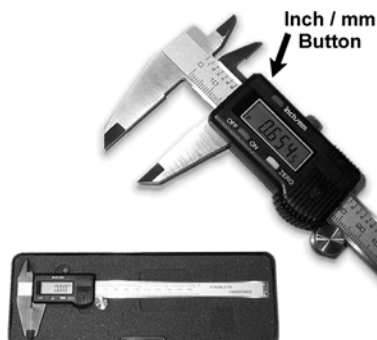

BULLS EYE SURFACE LEVEL

FLAT SPIRIT LEVEL

Temporary or permanent Shows level in 2x planes Base diameter is 45mm

Code
HT6451



ORTOFON SPIRIT LEVEL

Deluxe Turntable Type Base diameter is 25mm As used on plinths, etc.

Code
PCT230



LEVEL MEASURING TOOL

Key ring leveller is a great solution for level problems. Very handy, Small size, Unbreakable material and Light weight. Multipurpose more useful due to small size. Size: 40x15x15mm

Code
TL-KC01



TRIPLE SPIRIT LEVEL 9"

"TORPEDO" MAGNETIC

Made of tough ABS plastic Aluminium long-life edges Bottom edge is magnetic Holds to Iron/Steel surfaces for hands free Pipe groove & top window Three spirit levels for Level, plumb and 45° Quality build tool

Code
HT90216



TRIPLE SPIRIT LEVEL 12"

I-BEAM ALUMINIUM

Made of tough Aluminium Unbreakable spirit levels Painted industrial yellow Bottom edge polished flat Three spirit levels for Level, plumb and 45° Quality build tool

Code
HT90210



AUTO LEVEL LASER CHALK

LASER LIGHT GENERATOR

Auto levelling - Projects a laser cross line. Vertical and horizontal laser line (2134mm from the wall projects 1980mm of straight beam light). 4 positions switch, OFF / Vertical / Horizontal / Cross line. Lock switch to protect the mechanism of the level when during transportation. Out of auto-levelling range indication. Base screw for tripod operation. Magnetic base. 1.5V x 2 pcs. (AA) batteries [not included]. Size: 93x78x57mm

Code
MS771





↓ Mirror

DENTIST MIRROR

"Say Ahh!"
Excellent assistant for inspecting components, etc. in hard-to-reach places. Plastic.
20mm mirror.
150mm handle.
135 angled.

Code
HT922



TELESCOPIC DENTIST MIRROR

METAL PROFESSIONAL

32mm Mirror. Extends
140mm to 535mm !
Chrome. Bendable neck.
Glass mirror.

Code
HT8567



GOOSE-NECK MIRROR

50mm ON A BENDABLE 0.5M ARM

Aluminium flexible neck 480mm long. Manoeuvre, bend, twist into position 2" Square glass mirror.

Code
HT8570



→ Lighting & Torches

INSPECTION MIRROR ILLUMINATED

LARGE 40x80mm MIRROR

Larger tool for better viewing
Includes Lamp on end of shaft
Any angle neck adjust (Locks)
Bendable Aluminium Goose-Neck
Full 430mm long extends reach
Silver/Glass mirror 41x86mm
Requires "AA" x2 batteries

Code
HT8575



GOOSE-NECK LAMP

MAGNETIC BASE

Third hand spy lamp High
brightness LED Flexible
400mm neck Wrap-around
to hold Strong Magnetic
base attach to any metal
Button cells included.
Great assistant White LED

Code
HT8898



→ Magnifiers

50mm ILLUMINATED MAGNIFIER

Lens is NOT Acrylic but
proper coated glass!
Illuminated. Ideal for
component identification,
etc. Requires 2 x 'AA'
batteries. Glass Lens 3.5X

Code
IMG50



REPLACEMENT GLOBE

Code
653-3SB

75mm ILLUMINATED MAGNIFIER

Large, easy grip handle.
Easy to clean, scratch
resistant glass lens.
Suitable for reading and
component ID, etc.
Illuminated. 4 x 'AA' Req'

Code
IMG75



REPLACEMENT GLOBE

Code
653-3SB

110mm HANDS-FREE MAGNIFIER

Hangs around your neck so your
hands are free to work. Ideal
for intricate work, reading, etc.
Quality Construction, large coated
glass lens. Easy to clean, Scratch
resistant. Clip-on illuminator
included for optional assisted
viewing. Requires 2 x AA' batteries.

Code
IMG110



HANDS-FREE HEADSET MAGNIFIER

Cushioned headband Reduce
eye strain Worn with/without
your eye-glasses. Light weight,
comfortable. 2.0x Medium
Magnification lenses included.
Interchangeable lens.
Flips up out of the way.
Acrylic no-scratch lens.
Made USA www.mageyes.com

Code
IMG384



MAG-EYES LENS ONLY

Upgrade your magnification.
Original USA made MagEyes.
Optical quality acrylic.
Suit IMG384 MagEyes above.

2.25x MEDIUM STRONG MAG'

Code
IMG255

2.75 STRONGEST MAG'

Code
IMG257

ADDITIONAL LENS ONLY





→ Magnifiers

HANDHELD MAGNIFIER

WITH LED LIGHT

Expanding handle for desk top free-standing folding adjustable

Length	200mm
Lens	90mm
Mag.	Main 2.75x Small 6.00x
Code	IMG8090



BENDABLE MAGNIFIER

DESK STAND

Metal goose-neck adjustable with stable weighted stand Built-in LED lighting

Neck	150mm
Lens	110mm
Mag.	Main 2.0x Mini 4.0x
Code	IMG4110-DT



BENDABLE MAGNIFIER

DESK CLAMP

Metal goose-neck adjustable with desk clamp 40mm max. Built-in LED lighting Neck 150mm Lens Diameter 110mm Mag Main .0x Mini 4.0x

Neck	150mm
Lens	110mm
Mag.	Main 2.0x Mini 4.0x
Code	IMG4110-CL

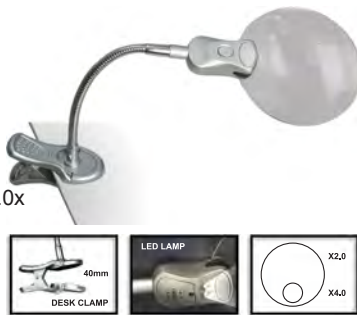

HELPING HANDS 65MM

Hold tiny objects and magnify them for precision work. 6 Ball Joints for all angles. 65mm 2x Magnifying glass. Heavy cast-iron base. Alligator spring clips. Locks to any angle.

Code	HTA65
------	-------



HELPING HANDS 90MM

Sturdy Heavy-Duty design Assists with holding objects and magnifies for precision work Fully adjustable angles Heavy cast-iron base with sponge or parts holder tray (60mm) 90mm 2x Magnifying glass 2x Alligator spring clips

Code	HTA90
------	-------



MAGNIFYING LAMP DESK

ELECTRONIC BALLAST

Compact desk-top lamp with magnification as used for meticulous detailed work 95mm magnifying lens with a 5 diopter scratch resistant lens surrounded by a round 12W fluoro tube or 32x Super bright LEDs for excellent illumination. Adjustable angle mast 400mm max Ball-In-Socket head joint. 240Vac. Weighted base.

LED ILLUMINATED

32x Super Bright LEDs

Code	IMG2012B-LED
------	--------------

FLUORESCENT TUBE

Desk Lamp with 12W Round Tube. Energy efficient electronic ballast.

Code	IMG2012B
------	----------

REPLACEMENT GLOBES

28W 200mm Suits IMG2012B

Code	LMP2012
------	---------



4 pin 12W



97mm I/D
120mm O/D

MAGNIFYING LAMP PROFESSIONAL

5 DIOPTER



Professional laboratory grade magnifier and lamp assembly. Work bench edge clamp base. Excellent construction and superior adjustability unit with 3 articulation joints. Heavy duty, hidden springs, easy to manoeuvre assistance. Glass lens surrounded by a 22W round fluorescent tube or 56x Super bright LEDs for illumination and vision. Includes clamp base. Optional stands stable for 300mm arm version only.

LED ILLUMINATED

56x Super Bright LEDs.

Arm	Code
300mm x2	IMG6016LED-12
400mm x2	IMG6016LED-16

FLUORESCENT TUBE

Desk Lamp with 22W Round Tube.

300mm x2	IMG6016-12
400mm x2	IMG6016-16

REPLACEMENT GLOBES

22W 205mm 4 Pin

Suit	Code
IMG6016	LMP6016



DESKTOP BASE

Weighted base for a non-scratch desk-top. Base only. Requires 6016 Series Lamp. Suitable for shorter 300mm arms only.

Code	IMG01
------	-------

TROLLY STAND

Four caster-wheel trolley stand 600mm tall. Base only. Requires 6016 Series Lamp. Suitable for shorter 300mm arms only.

Code	IMG04
------	-------



→ Lighting & Torches

LED SPOTLIGHT KIT

MAGNETIC BASE OR DESK CLAMP

Goose Neck to Focus bright, clear light exactly where it's needed, anywhere it's needed!

With a powerful magnetic base, a clamping metal sub-base and a flexible Gooseneck, this 14 LED-bulb lamp anchors down on power tools, workbenches and more, then bends and flexes its way into perfect position while staying out of your way. Great for delicate cuts, precise drilling, under the bonnet, in the field or whenever you need to brighten up your view.

- **THREE INTERCHANGEABLE LAMPS** Three lamp options are fully interchangeable with each other.
- **1/ LED LAMP** Included in the kit is a 35mm diameter Spotlight Head with 14 LEDs for excellent work space illumination.
- **2/ FOCUS BEAM** A super high brightness single LED bulb with adjustable lens for focusing the light beam to precision viewing.
- **3/ MAGNIFIER LAMP** Magnifying lens 110mm coated glass surrounded with 18 LEDs. Five times (5x) magnification.
- **DESK CLAMP** Bracket is great for adding light to operations on wooden tables, drill presses, and benchtops, magnet base clips to this bracket.
- **BATTERY OR MAINS** Includes power pack for 240Vac mains operation. Includes 3x AAA batteries for portable solution, use of LEDs provide excellent battery life.
- **LED ILLUMINATION** LED bulbs last longer, use less energy than incandescent or fluorescent bulbs. Extends battery life and resists knocks and vibrations, etc.
- **WEATHER RESISTANCE** Ingress protection for dusty and dirty environments. Metal gooseneck is plastic coated. Light heads are sealed in protective casings.
- **PREMIUM GRADE** Excellent build quality and full options for a lighting solution to suit many situations.
- **LAMP KIT** 14 LED Lamp, Focus Beam Lamp, Mag Lens Lamp, Goose-Neck Base, Power pack mains, 3x AAA Batteries, Desk Clamp Bracket, Base 60mm Diameter, Length 600mm Total.



Code
IMG6429

MINING LAMP

HANDS FREE LIGHTING

Adjustable elastic strap for wearing of your head hands-free light pointing Adjustable angle & brightness



Type	Code
12 LEDs	SNHD12

LED CAP LIGHT

HAT RIM CLIP

Fits to front rim for hands free illumination. Suit hands-free working. Night safety bike-riding. Thin curved style for popular base-ball caps. 5 super-bright LEDs. 12,000mcd brightness. 2x CR2032 batteries. 80x50x10mm.



Code
TORCHL79

FITS ANY CAP
[CAP NOT INCLUDED]

DROP LIGHTS

12V FLUORO TUBE 13W

Bright fluoro lamp with hook for under bonnet, camp sites, etc. 12Vdc. Includes 3.0M cable to accessories plug. 370mm Long.

Code
TT1104

LED WORK LIGHT

26X Super Bright LEDs. Charge from mains or Car 12V. 435mm

Code
WL3



TORCHES

Too many to list here!

For our comprehensive range of Torches including standard flash-lights, LED torches and our Fronta Diver Torch range See Section 12...



Section 12



→ Power Tool

↓ Hot Glue Gun & Glues

GLUE GUN KIT

HIGH POWER 60W

Professional portable Nicholson brand tool Mains powered gun Bonus plastic case and storage for the included glue sticks Trigger action gun 11mm glue sticks (x6)

Code NGG60D



HEAT GLUE STICKS

10 PIECES

Quality product Nicholson brand Suit Glue guns dries clear Order One to Receive ten 11mm x 100mm Pack of 10

Code NGS10



↓ Blow Torches

POCKET BLOW-TORCH

USES A COMMON LIGHTER

Use a common disposable lighter or the included Refillable Gas Cartridge Allows up to 20 Minutes of Continuous Use Up to 1300°C Peak Flame Temperature Wind-Proof Flame & Water-Proof Ignition Compact and Easy to Use torch solution Workshop, Tool Box, Work Bench etc.Suitable for Heavy Duty Soldering,Brazing, Silver Soldering, hobbies,with piezo push button ignition Compact focused flame solution

Code MJ300



GAS CARTRIDGE

Looks like a common lighter but is actually a REFILLABLE cartridge Replacement (Included with MJ300)

Code A7L2

GAS FLAMELESS HEAT GUN

USES A COMMON LIGHTER

Designed to provide flameless heating,not a direct flame, for reducing heatshrink insulation without burning it.Once started, the tip generates instant heat regulated at the correct temp for reducing heatshrink tubing (650C).Powered by a refillable gas cartridge,and with trigger-actuated piezo starter,it makes heatshrinking a breeze! Includes a refillable gas cartridge suitable for 20 minutes operation.

Code MJ600



GAS CARTRIDGE

Looks like a common lighter but is actually a REFILLABLE cartridge Replacement (Included with MJ600)

Code A7L2

70W GAS SOLDERING IRON

IRON ONLY

The advanced IRODA Soldering Iron offers go-anywhere soldering convenience,with an equivalent heat capacity 70 Watts.It features an adjustable heat control (210-450C),cap mounted flint igniter, long life catalyst tip and a 20ml gas reservoir for up to 2 hours use.

Code PRO70



70W GAS SOLDERING IRON

IRON & KIT

The kit comprises the IRODA Gas Soldering Iron supplied in a handy carry case with a range of tips and accessories including safety stand,cleaning sponge, solder dispenser, blow torch,hot air blower and hot knife cutter.

Code PRO70KIT





→ Soldering

↓ Blow Torches

MINI-BLOW TORCH

KEY-RING SIZED

"Magna Lite Blow Torch"
 Butane refillable
 Applications include
 Heatshrink tubing
 Fusing rope ends
 Unfreezing locks
 Piezo ignition Acute focusing
 Flame adjustable Weller branded



Code
 WML100

↓ Soldering Irons - Hand Iron

25 WATT SCOPE SOLDERING IRON

240 VAC with long life
 plated tips for electronic
 soldering at around 380°C
 Stainless steel barrel.
 Impact resistant handle.

Code
 MH25

REPLACEMENT TIPS

Type	Code
TIPS	MH25ZF
TIPS	MH25SF
TIPS	MH25DF
TIPS	MH25DFB

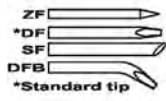

25 WATT SOLDERING IRON BARGAIN PRICED

GENERAL PURPOSE HOBBYIST

Excellent economical solution
 for general purpose soldering.
 240Vac. Cool grip handle.
 Stainless steel barrel.

Watt Code
 25W ESI25

TIP TO SUIT

Code
 ESI25TIP



40 WATT SCOPE SOLDERING IRON

240 VAC with longer plated
 tips for sustained heating at
 around 380°C Stainless steel
 barrel. Impact resistant.

Size Code
 40W MH40

TIPS

Type	Code
TIPS	MH40ZF
TIPS	MH40SF
TIPS	MH40DF
TIPS	MH40DFB



40 WATT SOLDERING IRON BARGAIN PRICED

GENERAL PURPOSE HOBBYIST

Excellent economical solution
 for general purpose soldering.
 240Vac. Cool grip handle.
 Stainless steel barrel.

Watt Code
 40W ESI40

TIP TO SUIT

Code
 ESI40TIP



80 WATT COOPER TOOLS SOLDERING IRON

High power for those
 temperature hungry jobs.
 Special Price! Includes two
 tips: Blunt conical (pen) &
 Flat wedge (Screw driver)

Size Code
 80W SI-N80D

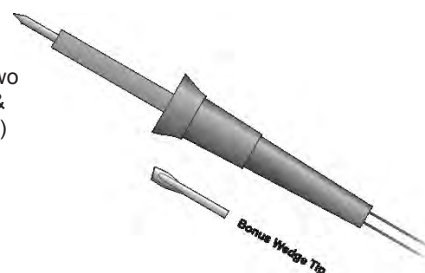

80 WATT SOLDERING IRON BARGAIN PRICED

HEAVY DUTY HOBBYIST

Excellent economical solution
 for larger solder work like
 Lead-Light, metal work, etc.
 240Vac. Cool grip handle.
 Stainless steel barrel.

Watt Code
 80W ESI80

TIP TO SUIT

Code
 ESI80TIP



175 WATT WELLER HEAVY DUTY IRON

SUPER HIGH POWER!

16mmØ tip iron plated.
 320mm long. 450g +Cord.
 Australian Made.

Size Code
 175W SP175D

REPLACEMENT TIP

Description Code
 Chisel 16mm MTG40





↓ Soldering Irons - Hand Iron

20 WATT HAKKO SOLDERING IRON

High quality Light Weight (40g) Suitable for all general applications Ideal Hobby Iron or spare in the tool box, etc.

Size	Code
20W	HK500W

Tips

Code
500-BB3



60 WATT HAKKO SOLDERING IRON

Size	Code
60W	HK503W

Tips

Code
503-BB6



www.wescomponents.com/datasheets/hakko/

55 WATT / 110 WATT HAKKO MACH-1

Super Fast Thermal Recovery! Professional Hand Held Soldering Iron

Compact, comfortable, foam handle grip, light weight (50g), flexible 240V cord. Hollow tip ceramic heater technology. 120W heatup, 55W idle for 370°C. Thermal IC controlled. The best!

Size	Code
55W	HK921

SOLDER STATION IN A HAND HELD !

Description	Code
Heater	921HV24
Tips	920TB



More tips are available: www.wescomponents.com/datasheets/hakko/

↓ Soldering Irons - 12V & Battery

12V SOLDERING IRON

12 volt DC soldering iron
40 watt with 4.5M cord to
Accessories plug. Ideal
for in-field work on the
car or boat, etc.

Code
SI4

TIPS

Code
SIT40



12V PORTABLE WELLER IRON

42W WITH BATTERY PACK

Portable hand tool solution
Long life operation soldering
Carry case with 12V 7.2Ah SLA
Recharges from car accessories
Premium Weller soldering iron
Temperature controlled tip
Standard sized light weight
Rugged carry case w/ stand
Made in Australia

Code
WPSI12V



BATTERY SOLDERING IRON

COMPACT SOLDER SOLUTION.

A lightweight and compact 8W battery powered soldering iron for use in areas where mains power is not conveniently available. Operates on 3 "AA" size alkaline batteries (not supplied). Size: 197x37x21mm. Two models are available with wedge tip or with Conical tip. Heats up only in 15 seconds. Cools down in only 30 seconds. Can be used for offices and home. Continuous run time of up to 1 hour with Alkaline batteries.

Type	Code
Wedge Tip	SI8WED
Conical Tip	SI8-CON

REPLACEMENT TIPS

Type	Code
Wedge	SIT8WED
Conical	SIT8CON





14 TOOLS & TEST EQUIPMENT

14 TOOLS & TEST EQUIPMENT

↓ Soldering Irons - Gas

WELLER WSTA-6 PYRO-PEN POCKET IRON

Don't be caught without an iron again!
Truly compact, fits in your shirt pocket!
Quality product that
Solders & Hot-blows.
Spare parts available.

Code
WSTA6

TIPS TO SUIT

Description	Code
Taper 1mm	WPT01
Bevel 2mm	WPT03



WELLER PSI-100K PORTASOL

125W BUTANE IRON

Professional kit.
Self igniting ESD safe.
Safety shut-off. Fuel
window. Stainless steel.
Adjustable temp. Solder
& Blow. 4 Tips included.
Carry Case holder

Code
SPIK



WELLER WPA-2 PYRO-PEN SOLDERING IRON

Runs up to 3Hrs on one fill
of lighter fluid. Lightweight.
Comfortable. Metal storage
box. **Piezo Ignition.** Includes
Soldering & Hot-Blow tips.
Spare parts available.

Code
WPA2

TIPS TO SUIT WPA2

Description	Code
Taper 1mm	WPT1
Chisel 2mm	WPT2
Spade 2mm	WPT3



WELLER WSTA-3 PYRO-PEN SOLDERING IRON

Professional service tool.
This iron is identical to the
WPA2 butane iron with
solder & hot-blow but with
a controllable **Flame-torch**
instead of the piezo ignition.

Code
WSTA3

TIPS TO SUIT WSTA3

Description	Code
Taper 1mm	WPT1
Chisel 2mm	WPT2
Spade 2mm	WPT3



WELLER WSTA-5 JUMBO PYRO-PEN

1 Ft SELF IGNITING IRON

Large Heavy-Duty Butane.
300mm long with 10mm tip.
For high temp applications.
Temp Range 250°C to 500°C.
Includes 72-01-02 tip. Hot-blow
torch nozzle. Heatshrink shield
cup. Metal storage case. Spare
parts available. Made in Japan.

Code
WSTA5

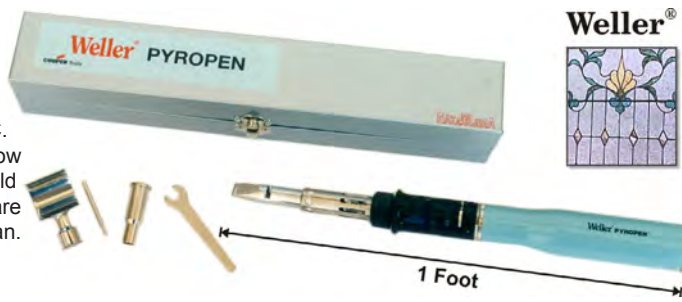

WELLER PSI-100K TIPS

SINGLE FLAT

Size	Code
1.0mm	PSI-1
2.4mm	PSI-2
3.2mm	PSI-3
4.8mm	PSI-4

DOUBLE FLAT

Size	Code
1.0mm	PSI-5
2.4mm*	PSI-6
3.2mm	PSI-7
4.8mm*	PSI-8
Blower*	PSI-9
Knife*	PSI-10

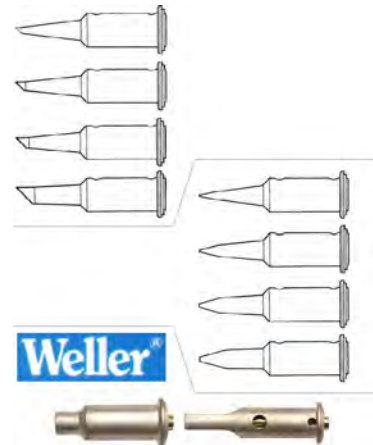

WELLER WPA-2 PARTS

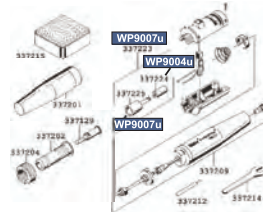

Description	Code
Ejector	WP9007
Burner Unit	WP9004U
Ejector Unit	WP9007U

Code	Description	Tp Size
WPT-1	Taper	
WPT-2	Chisel	2.0
WPT-3	Spade	2.0
WPT-4	Spade 40°	3.0
WPT-5	Spade Bevel	3.0
WPT-6	Blow Tip	2.0
WPT-7	Spade Taper Bevel	3.0
WPT-8	Spade 30°	3.0
WPT-9	Blow 30°	3.0
WPT-10	Other Taper Bevel	3.0
WPT-11	Chisel	3.0
WPT-12	Blow 45° Bevel	3.0
WPT-13	Long Taper Bevel	3.0
WPT-14	Truncated Py Bevel	3.0
WPT-15a	Spade	7.0
WPT-15b	Hot Blow	0.5 B
WPT-15c	Hot Blow	0.5 B
WPT-15d	Hot Blow	4.0 B
WPT-15e	Hot Blow	7.0 B
WPT-16	Hot Blow 45° Bevel Long	
WPT-17	Hot Blow 45° Bevel Long	

WELLER WSTA-3 PARTS

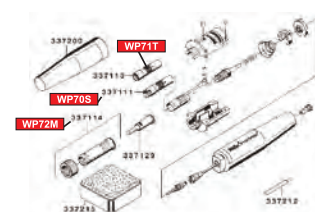

Description	Code
Torch Ejector	WP71T
Solder Ejector	WP70S
Tip Housing	WP72M

Code	Description	Tp Size
WPT-1	Taper	
WPT-2	Chisel	2.0
WPT-3	Spade	2.0
WPT-4	Spade 40°	3.0
WPT-5	Spade Bevel	3.0
WPT-6	Blow Tip	2.0
WPT-7	Spade Taper Bevel	3.0
WPT-8	Spade 30°	3.0
WPT-9	Blow 30°	3.0
WPT-10	Other Taper Bevel	3.0
WPT-11	Chisel	3.0
WPT-12	Blow 45° Bevel	3.0
WPT-13	Long Taper Bevel	3.0
WPT-14	Truncated Py Bevel	3.0
WPT-15a	Spade	7.0
WPT-15b	Hot Blow	0.5 B
WPT-15c	Hot Blow	0.5 B
WPT-15d	Hot Blow	4.0 B
WPT-15e	Hot Blow	7.0 B
WPT-16	Hot Blow 45° Bevel Long	
WPT-17	Hot Blow 45° Bevel Long	

Weller®



WSTA5 WELLER TIPS

Description	Code
Conical 3mm	720101AU
Chisel 4mm	720102
Spade 4mm	720103
Conical 2mm	720105
Spade 4mm	720106
Pyramid 2mm	720107AU
Flat 3mm	720113
Hot Blow 4mm	720151
Hot Blow 6mm	720152
Hot Blow 10mm	720153



↓ Soldering Irons - Weller

WELLER 42W MAGNASTAT SOLDERING STATION

Weller Magnastat system is a ferro-magnetic sensing device which switches on specific temperature is reached. Using a magnet system is more reliable. In this way power to the heating element can be quickly switched on or off to either provide extra power for soldering or reduced power when idling. Working temperature selection is achieved by changing the Magnastat tip. These are available in temperature ratings of 315C, 371C and 427C. The tips are made of pure copper for effective heat conductivity. The heating element has an optimal heating effect on the tip. Kit includes TC201B 42 Watt 24V Standard sized pencil iron TC202DT2 Base station and separate iron stand with sponge. Professional unit with 1.6mm 371°C "PT" Series tip

Size	Code
42W	WTCPTD

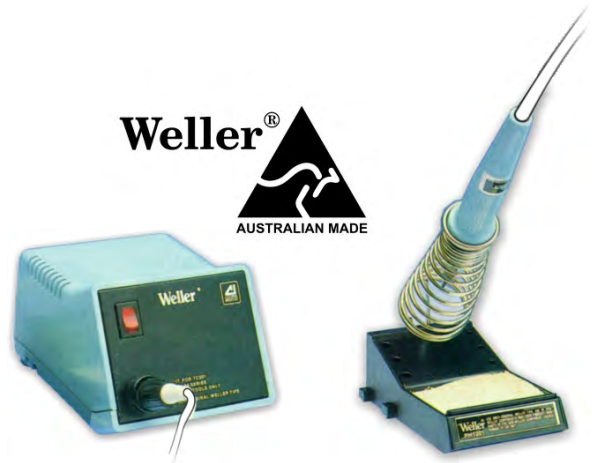

WELLER 50W ADJUSTABLE SOLDERING STATION

ANALOGUE TEMPERATURE CONTROLLED & ADJUSTABLE

The tip temperature is electronically controlled by thermal circuitry. Adjustable directly from the front panel dial 150°C to 450°C (+/-3%). Basic design affords a professional station at an economical price. Kit includes WES51DPU power unit with separate deluxe iron stand PES51 is a slim comfortable light-weight 50 Watt soldering pencil. The ET series tips have a quick recovery time and long life. Reduce operator fatigue. Ideal for continuous operator soldering. Temperature lock-out. Auto switch off if left unused. High-end performance station assembled in Australia. Spare parts available. ET series tips (ETA supplied)

Size	Code
50W	WES51D



WELLER 50W DIGITAL SOLDERING STATION

DIGITAL TEMPERATURE CONTROLLED & ADJUSTABLE

The tip temperature is precision Micro-processor monitored & controlled. Temperature adjustable directly from the front panel dial 150°C to 450°C. Direct iron tip temperature monitored by 3 digit LED readout in °C or °F. The kit includes WESD51DPU digital power unit with a separate iron stand PES51 is a deluxe slim comfortable light-weight 50 Watt soldering pencil. The ET series tips have a quick recovery time and long operational life. Suits soldering of sensitive electronics susceptible to over temperature. Excellent rework station, production, Thru-hole SMT boards, Multi-Layer boards, etc. Base has wireless Temperature lock-out and Auto switch off. Assembled in Australia. Spare parts available. ET series tips (ETA supplied)

Size	Code
50W	WESD51D



WELLER 80W PROGRAMMABLE SOLDERING STATION

MICRO-PROCESSOR TEMPERATURE CONTROLLED & ADJUSTABLE

The higher reserve power vastly improves tip temperature recovery time. The tip temperature is precision Micro-processor monitored & controlled. Temperature adjustable digitally 50°C to 450°C and has 3 direct presets. Programmable stand-by time, Auto-Off, Temp window, Temp offset, Lock-out. Direct iron tip temperature monitored by 3 digit LCD readout in °C or °F. WP80 is a deluxe slim short neck-to-tip light-weight 80 Watt pencil. A new concept in soldering iron design offers low operator fatigue, Greater control, Improved performance, ease of use, a pleasure to use! The small foot print switchmode base unit uses less desktop bench space. LT series of tips available (LTB supplied). Made in Germany. ROHS & WEEE.

Size	Code
80W	WD1000





WELLER SOLDERING IRON PARTS

For part listings, be sure to keep the units manual!

Older parts are available.....



More are available

If we don't have stock we can order them in with minimal delay. for Hakko or Scope, etc. parts are available.



WELLER STATION

WT-CP,
WT-CPL,
WT-CPN,
WT-CPS,
WT-CPT,
WT-CPT-D
WT-CPZ,
etc., TC-P1
& TC-P12.



WELLER WT-CP PENCIL

Iron Complete

Code
TC201



WELLER HEATER SUIT TC201

Volts	Watt	Code
24V	60W	HE60-24



WELLER HEATER-SWITCH SUIT TC201

Code
SW60D

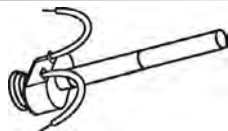

WELLER BARREL-NUT SUIT TC201

Code
BA60



WELLER HANDLE ONLY SUIT TC201

Code
HO60A



WELLER CORD SET & HANDLE

Code
TC203A



WELLER PLUG & RECEPTACLE

Code
TC369A

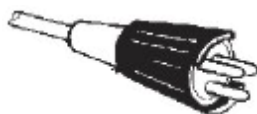

WELLER SPONGE

Sponge Only
Suit Weller
Iron Stand

Code
TC205

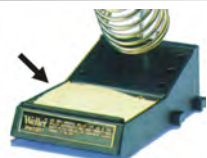

WELLER WT201 WT-CPT-D

PTA - WEDGE 1.6

Temp.	Code
371°C	V10-700
427°C	V10-800



PTH - WEDGE 0.8

Temp.	Code
371°C	V16-700
427°C	V16-800



PTK - LONG 1.2

Temp.	Code
371°C	V17-700
427°C	V17-800



PTP - CONICAL 0.8

Temp.	Code
371°C	V20-700
427°C	V20-800



PTCC - WEDGE 3.2

Temp.	Code
371°C	V23-700
427°C	V23-800



PTO - SHARP 0.4

Temp.	Code
371°C	V26-700
427°C	V26-800



WELLER TIPS TO SUIT EC STATIONS

Temperature Controlled Stations EC1000, C1001, EC1002, EC2000, EC2001, DS1003, WEC-P, WEC-24, etc.



ETA - WEDGE 1.6mm

Code
E40



ETK - LONG 1.2mm

Code
E47



ETO - SHARP 0.8mm

Code
E56



ETP - CONICAL 0.8mm

Code
E50



TETS - SHARPER 0.4mm

Code
E57





SCOPE SUPERSCOPE SOLDERING IRON

SUPERSCOPE FAST POWERFUL LOW VOLTAGE

Adjust heat instantly whilst soldering. 200-500°C 20-100 Watt. For medium to heavy duty soldering. **Requires PSU10**

Code
SI75

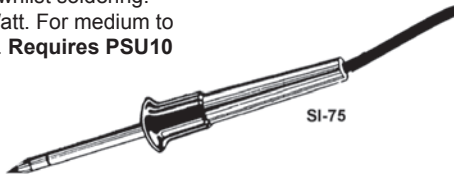

SCOPE POWER SUPPLY

3.3 volts high current.

Code
PSU10

SCOPE MINISCOPE SOLDERING IRON

Light weight Pencil iron for push button instant heat with adjustable temp' whilst soldering. 200-500°C. 10-70 Watt. For light to medium duty Precision soldering.

Requires PSU10

Code
SI85

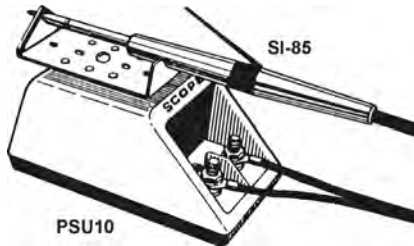

SCOPE POWER SUPPLY

Code
PSU10

SCOPE MINISCOPE & SUPERSCOPE SPARE PARTS

Description	Code
10x SuperScope tips, 6.4mm, 1A	SS1A
10x SuperScope tips, 3.2mm, 1B	SS1B
10x SuperScope heater elements.	SS3
3x tips & 2x elements Kit 1A/1B	05PS
1x SuperScope barrel	SS02
1x Ceramic Bead SuperScope	SS05



Description	Code
10x MiniScope tips, 6.4mm, 1A	MS21A
10x MiniScope tips, 2.5mm, 1B	MS21B
MiniScope Barrel	MS22D
10x MiniScope heater elements.	MS23
1X Ceramic Bead MiniScope	MS25

SCOPE TIPS TO SUIT OLDER SOLDERING IRONS

Iron	Type	Code
ETC30W/8	S	ZF0.8/59
ETC30W2	H	DF1.6/504
ETC30W2	H	DF2.0/505
ETC60W/8	S	DF0.4/23
ETC60W/8	S	SF0.8/21
ETC60W/8	S	DF1.2/26
ETC60W/8	S	SF1.2/27
ETC60W/8	S	DF1.6/24
ETC60W/8	S	SF2.0/57
ETC60W/8	S	DF3.2/25
ETC60W9	H	DF0.4/03
ETC60W9	H	DF0.8/02
ETC60W9	H	DF1.2/06
ETC60W9	H	DF1.6/04
ETC60W9	H	DF3.2/05
ETC60W9	H	DF5.0/10
PX10	H	DF1.0/B
PX10	H	DF2.0/2D
PX10	H	DF5.0/5K
TC60		DF32
TC60		DF64
TC60		SF16
TC60		SF32
TC60		SF64
PX10	H	SF1.0/BC
PX10	H	SF2.0/2C
PX10	H	SF3.0/3C
PX10	H	SF5.0/11
PH20, MH25		SF2475
PH20, MH25		DF3475
PH20, MH25		SF4475
PH20, MH25		ZF0475

Superseded Soldering Irons still require replacement tips! Here are the tips we have stock of. If you require a tip not listed, please enquire!

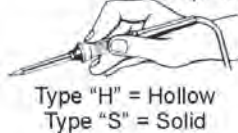

ETC60W/8 is for ETC60W & ETC60W8



SCOPE PARTS

SUPER-SCOPE and MINI-SCOPE

For parts to suit older or other Scope products. Please enquire.

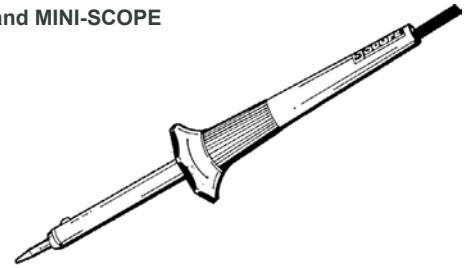

SUPERSCOPE HEATER ELEMENT

SUPER-SCOPE

10 pcs

Code
SS3



SUPERSCOPE 3.2mm

Conical

10 pcs.

Code
SS1B



SUPERSCOPE 6.4mm

Chisel

10 pcs.

Code
SS1A



MINI-SCOPE HEATER ELEMENT

MINI-SCOPE

10 pcs

Code
MS23



MINI-SCOPE 2.5mm

Conical

10 pcs.

Code
MS21B



MINI-SCOPE 6.4mm

Chisel

10 pcs

Code
MS21A



SCOPE - ZERO FLAT

Size Code
4mm MH25ZF
5mm MH40ZF



SCOPE - SINGLE FLAT

Size Code
4mm MH25SF
5mm MH40SF



SCOPE - DOUBLE FLAT

Size Code
4mm MH25DF
5mm MH40DF



SCOPE - BENT

Size Code
4mm MH25DFB
5mm MH40DFB





↓ Soldering Irons - Hakko

HAKKO FX888 SOLDERING STATION

LEAD-FREE & OUTSTANDING PERFORMANCE

Electrostatic Device safe soldering station. Update to the very popular Hakko stations with improvements to tip design & performance. Super quick heat-up and fast thermal recovery. Enables high quality soldering at lower tip °C. Built-in ceramic heater sensor inside the tip. Maintains temp quickly, within +/-1°C of setting. Manually adjustable temperature 200°C g 480°C. Supplied with a 65W rubber grip pencil & Stand. Specialised tips available.

Code
FX888



HAKKO FX888 PARTS & ACCESSORIES

REFER TO MANUAL FOR DETAILS

Description	Code
65W Pencil	FX8801-01
Iron Holder	FH800-01BY
Cleaning Sponge	A1559
Cleaning Wire	A1561
Rubber Cleaner	B3474
Heating element	A1560
Tip Enclosure	B3469
Nut	B1785
Nipple	B2022
Screwdriver	B3466

Tips

Code	Code
T18-B	T18-CSF25
T18-C3	T18-C3
T18-I	T18-CF3
T18-K	T18-C4
T18-SB	T18-CF4
T18-C05	T18-D08
T18-C1	T18-D12
T18-CF1	T18-D16
T18-CF15	T18-D24
T18-C2	T18-D32
T18-CF2	

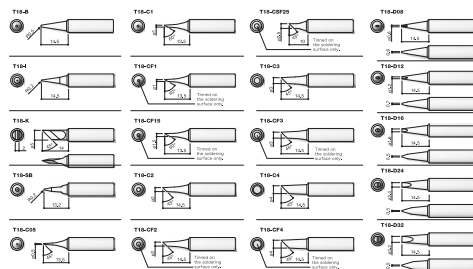

REMEMBER: HOLD ON TO YOUR MANUAL! http://www.hakko.com/english/products/hakko_fx888.html

HAKKO 936 SOLDERING STATION SPARE PARTS

REPLACEMENT IRONS 50W

Type	Code
Small	HK900S
Medium	HK900M
Medium	HK907
Large	HK908

IRONS TO SUIT 936 STATIONS

Type	Code
Small	HK900S-ESD
Medium	HK900M-ESD
Medium	HK907-ESD
Large	HK908-ESD

TWEEZERS

Code
HK950

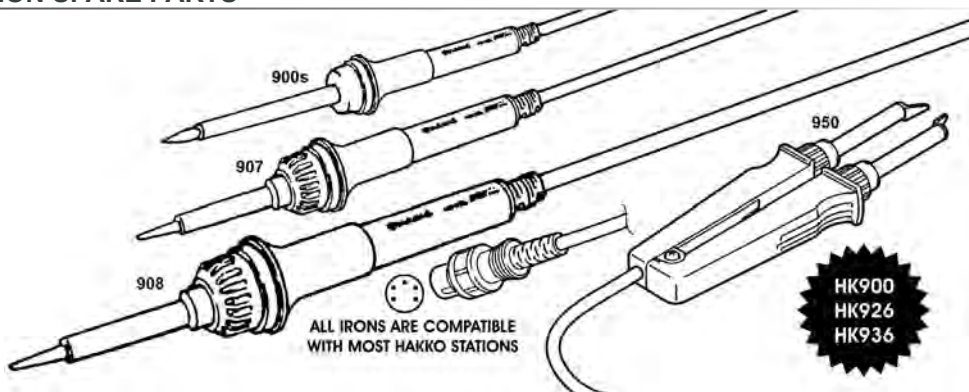

ALL IRONS ARE COMPATIBLE WITH MOST HAKKO STATIONS

HK900
HK926
HK936

HAKKO 936 SOLDERING STATION SPARE PARTS

MINI IRON HK900S & ESD

Description	Code
Nut	900S-006
Heater Element	900S-H

REPLACEMENT HK907 & ESD

Description	Code
Tip Enclosure	B1786
Nut	B1784
Nipple	B2022
Heater Element	900M-H

LARGE IRON HK908 & ESD

Description	Code
Cleaning Sponge	A1042
Heater Element	900M-H

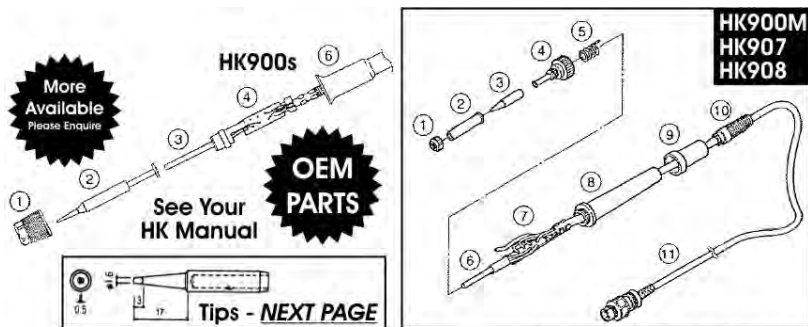

More Available
Please Enquire

OEM PARTS

See Your HK Manual
Tips - NEXT PAGE

MORE AVAILABLE! www.wescomponents.com/datasheets/hakko/

HAKKO 950 SMD HOT TWEEZER ACCESSORIES

SPONGE TO SUIT STAND

Code
A1386

REPLACEMENT TIPS (2 Supplied)

Size	Code
2.0x1.0	A1378
1.0x1.0	A1379
8.0x1.0	A1380
10.0x1.0	A1381
13.0x1.0	A1382
18.0x1.0	A1383
20.0x1.0	A1384
25.0x1.0	A1385

REPLACEMENT HEATING ELEMENT

Description	Code
One Supplied	A1377

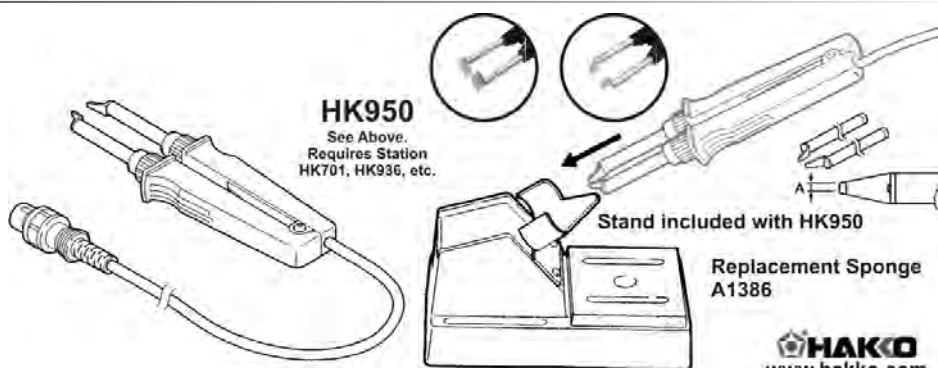

HK950
See Above.
Requires Station
HK701, HK936, etc.

Stand included with HK950

Replacement Sponge
A1386

HAKKO
www.hakko.com



HAKKO ORIGINAL TIPS

Please refer to your instruction manual for more tips available.

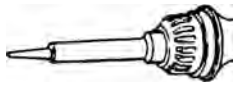

www.wescomponents.com/datasheets/hakko

HAKKO TO SUIT

HK900S Mini-Iron
HK900M eq. HK907
HK900L eq. HK908



If not listed, Please Enquire

HAKKO 900S TINY CHISEL

Code
900S-T-1.2D

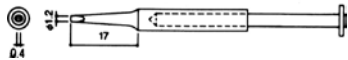

HAKKO 900S SMALL CHISEL

Code
900S-T-1.6D



HAKKO 900S TINY BEVEL

Code
900S-T-1C

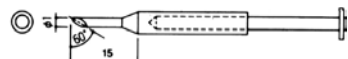

HAKKO 900S SMALL BEVEL

Code
900S-T-2C

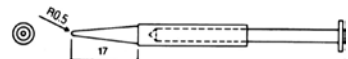

HAKKO 900S BLUNT CONICAL

Code
900S-T-B

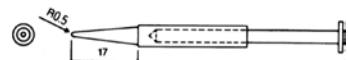

HAKKO 900S SHARP CONICAL

Code
900S-T-I

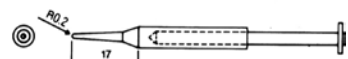

HAKKO 900S HEATER 50W

Code
900S-H

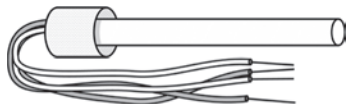

HAKKO 900M HEATER 50W

Code
900M-H

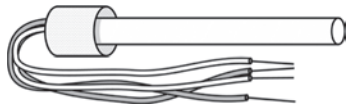

SPARE PARTS AVAILABLE

Please retain your manual!

Please refer to your original Spare parts diagrams as found in your HAKKO Instruction manual. or... www.wescomponents.com/datasheets/hakko

HAKKO 900M SMALL CHISEL

Code
900M-T-1.2D

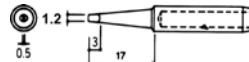

HAKKO 900M SMALL CHISEL

Code
900M-T-1.6D

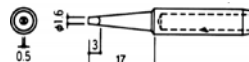

HAKKO 900M MEDIUM CHISEL

Code
900M-T-2.4D

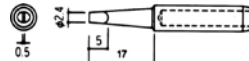

HAKKO 900M LARGE CHISEL

Code
900M-T-3.2D

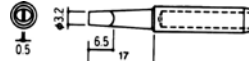

HAKKO 900M BLUNT CONICAL

Code
900M-T-B

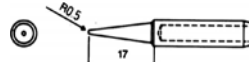

HAKKO 900M LONG CONICAL

Code
900M-T-LB

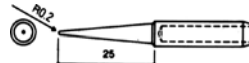

HAKKO 900M SHARP CONICAL

Code
900M-T-I

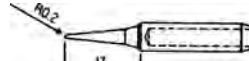

HAKKO 900M TINY BEVEL

Code
900M-T-1C



HAKKO 900M CHISEL SPECIAL

Code
900M-T-K



HAKKO 900M BENT SPECIAL

Code
900M-T-H

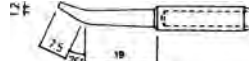

HAKKO 900M BEVEL (X=Size)

Size	Code
2mm	900M-T-2C
3mm	900M-T-3C
4mm	900M-T-4C

HAKKO 900M CUP STYLE TIP

Size	Code
3mm	900M-T-VK50
5mm	900M-T-VK51

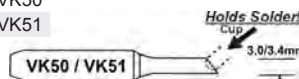

HAKKO 900M SMD BARREL

Required for the SMD tips listed below.

Code
900M-1000



HAKKO PLCC/MP 9x9mm SMD

Code
924-T-1002

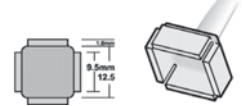

HAKKO PLCC/MP 12x12mm

Code
924-T-1003

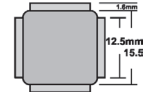

Req' 900M-1000

HAKKO PLCC/MP 13x13mm

Code
924-T-1004

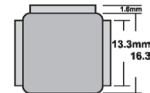

Req' 900M-1000

HAKKO PLCC/MP 14x14mm

Code
924-T-1005



Req' 900M-1000

HAKKO PLCC/MP 20x14

Code
924-T-1006

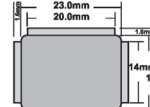

Req' 900M-1000

HAKKO PLCC/MP 17x17

Code
924-T-1007



Req' 900M-1000

HAKKO DIP/DIL 6mm SMD

Code
924-T-1010

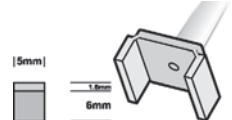

Req' 900M-1000

HAKKO DIP/DIL 6mm

Code
924-T-1011

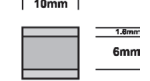

Req' 900M-1000

HAKKO DIP/DIL 7mm

Code
924-T-1012

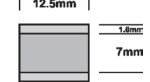

Req' 900M-1000

HAKKO DIP/DIL 9mm

Code
924-T-1013

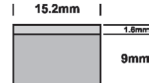

Req' 900M-1000

HAKKO DIP/DIL 9mm

Code
924-T-1014

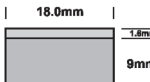

Req' 900M-1000



↓ Soldering Irons - Hakko

HAKKO FX951 SOLDERING STATION 70W

ESD SAFE DIGITAL TEMPERATURE CONTROL & COMPOSITE TIP IRON

Digital soldering station ideally suited to lead free soldering processes. Advanced technology. Vertical bench space saving design. Modern styling. Features programmable functions including power saving sleep settings to greatly extend the irons tip life. The stand detects iron placement and will stop energising the iron after the set sleep period of 1 to 30 min. T12 Series of composite tips are soldering tip, heater & thermal sensor all in the one compact design. This greatly improves thermal recovery Coupled to a powerful 70W source ensures superior performance.

Code
FX951



NO TIP SUPPLIED - See Listing Below...
[eg. 0.2B T12-B] or www.hakko.com



HAKKO TIPS NOZZLES & SPARE PARTS - PLEASE REFER TO PRODUCT MANUAL

FX951 T12 SERIES Active tips See manual for details

Description	Code
0.2mmØ Composite Tip	T12-B
0.5mmØ Composite Tip	T12-B2
1.2mmØ Composite Tip	T12-D12



HAKKO FR801 SMD REWORK STATION

HOT AIR BLOWER WITH GAUGE

New improved model featuring an updated mechanism and heating system Consistent temperature of hot air is afforded by this new design Adjustable airflow volume control with direct analogue airflow meter This improved performance provides easier, quicker, professional results New automatic cool-down function improves the heater elements life time The new modern design unit is also more compact and fully ESD safe Air blow capacity is adjustable from 5 to 20 Litres per minute Hot Air Temperature is adjustable from 100°C to 420°C (using A1126B) A comprehensive range of air nozzles and parts are available separately.

Code
FR801

NO NOZZLE SUPPLIED www.hakko.com
[Too many to list here.]



FR801 BLOWER

Same Nozzles as 850 See manual for details

Description	Code
Replacement Heater Element	A1522
2.5mmØ Standard Nozzle	A1124B



ALL PARTS, TIP, NOZZLES AND ACCESSORIES ARE AVAILABLE WITH SHORT DELAY

HAKKO FX301 SOLDERING POT

LEAD-FREE COMPATIBLE

Four heating programs for optimum temperatures to suit most solder types Sn-Pb (Tin/Lead), Sn-Ag-Cu (Tin/Silver/Copper), Sn-Cu (Tin/Copper) Sn (Tin) Microprocessor Temperature controllable with digital temperature display High performance Ceramic heating element with two sized pots available Pot size included 50mm². Additional pots and 75mm² pots are optional extras Suits terminal treatment of wires, removal of electronic components, etc. Convenient programmable timer function helps keep tabs on how long the solder has been in use making it easy to judge when to replace the pot New improved performance tool gives excellent thermal recovery Displays °C or °F. ESD Safe. 400°C to 840°C Max

Code
FX301





↓ Soldering Irons - Induction

THERMALTRONICS SOLDERING STATION - INDUCTION TYPE

13.56 MHz RADIO FREQUENCY INDUCTION CURIE HEAT SOLDERING SYSTEM

A new generation of soldering stations now using induction technology. The TMT-9000S2 is based on "Curie Heat Technology" which responds to the thermal demands of each solder joint by adjusting the power instantaneously at the tip, not through the barrel as conventional irons do, thereby meeting the exact requirements of the substrate component and solder material. This new technology saves tips by not over heating them, saves components from damage and saves operator fatigue due to efficiency, speed and ease of use. The kit comprises a 13.56 MHz Power Supply with LCD display, a slim soldering handpiece with comfort grip, workstand and an unique tip cartridge. Additionally, two switchable soldering ports are offered with the System for expansion (SHP-1). ESD safe. Certified in accordance with TUV, CE, GS & NRTL standards.



ONE TIP SUPPLIED. MORE AVAILABLE www.thermaltronics.com/tipcartridge.php

Code
TMT9000S2

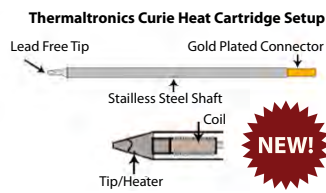
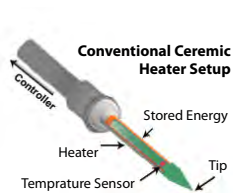

TMT9000S REPLACEMENT ACCESSORIES

Description	Code
TMT9000S Holder	SHH-1
TMT9000S Handle	SHP-1
TMT9000S Brass Curls	BC-10
TMT9000S Sponge	SPG-5



TMT9000S Tips 350°C - 398°C www.thermaltronics.com/tipcartridge.php

Type	Size	Code
Bent 30°	0.4mm	M7B325
0.4mm	Conical	M7C300
2.5mm	Chisel	M7CH175
Chisel	1.78mm	M7CH176
Chisel	1.5mm	M7CH177
Chisel	1.0mm	M7CH178
Chisel	5.0mm	M7CH250
Wave	3.0mm	M7WV300
Conical	0.4mm	M7CS152
Conical	0.5mm	M7CS155
2.03mm	Knife Tinned	M7K100
Sharp Bent	0.5mm	M7SB276

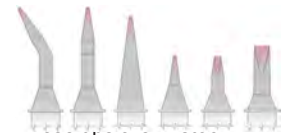

Other temperatures are available but not listed.
M6 (325°C - 358°C)
M8 (420°C - 475°C)
Tips ordered in on request.
See website for more...
www.thermaltronics.com

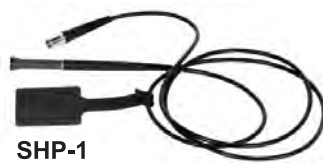

↓ Soldering Irons - Hakko

HAKKO DESOLDERING HAND-HELD

The unique Hakko design places the pump and motor above the handle, not inside the grip, so vibration is minimal and the grip easy to hold. The new miniature high-performance diaphragm pump is housed in the pump chamber at the rear of the unit. So pump maintenance is quick and easy. Simply remove the cover of the pump chamber. Extra filters are available. Heater is 70W for 380-480°C. Double cylinder 6.5W 10L/Min diaphragm pump ESD Safe tip to ground less than 2ohms. 1mmØ A1005 Nozzle supplied. 420g.

Code
HK808



CERAMIC PAPER FILTERS
(Small) X10

Code
A1033

HK808 DESOLDER

More available See manual for details

Description	Code
0.8mm+1.8mmØ Nozzle	A1002
0.8mm+2.3mmØ Nozzle	A1004
Ceramic Filter S (x10)	A1033
Set of 5 pre-filter (alum)	A1267

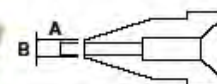
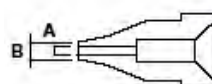



14 TOOLS & TEST EQUIPMENT

↓ Soldering Irons - Hakko

HAKKO DUAL SOLDERING & DESOLDERING STATION



ESD SAFE REPAIR SYSTEM DUAL STATION

Combining a powerful desoldering gun with a high performance soldering pencil in one station for convenient & accurate control and more effective and efficient workshop production & rework situations. Premium Professional Reliable Equipment. HK907ESD Solder Iron (200 g 480°C) HK809 Desolder Gun (380 g 480°C) With Stands, Tools, Manual, etc.



Code
HK700

Parts and accessories are available.



HAKKO 474 DESOLDERING/REWORK STATION ESD SAFE

VACUUM PUMP TYPE "SOLDER SUCKER" GUN

Powerful 50W Temperature controlled fast-recovery Gun. Completely ESD safe, Zero-cross switching Low V, etc. HK809 Desoldering Gun with quick filter access and easy cleaning maintenance design reducing work time. Base station air compressor type for superior vacuum pressure and also lighter, more comfortable hand control. Excellent Rework and repair solution that saves time. Hakko quality means long term service reliability. Includes tip, filters, cleaners, stand, manual, etc.



Code
HK47410

Spare parts and other tips available, see manual.

HAKKO HK474 HK701 HK809 DESOLDERING TOOL SPARE PARTS

HK474 & HK701 SPARE PARTS

Description	Code
Diaphragm	A1013
Valve Plate	A1014
Ceramic Filter S (x10)	A1033
Ceramic Filter L (x10)	A1009

HK809 CLEANING

Description	Code
Clean Heating	B1215
Cleaning Pin 0.8mm	B1086
Cleaning Pin 1.0mm	B1087
Cleaning Pin 1.3mm	B1088
Cleaning Pin 1.6mm	B1089

HK809 SPARE PARTS

Description	Code
Gun Complete	HK809
O-Ring P-12 (x5)	A1012
Spring Filter (x10)	A1030
Ceramic Filter S (x10)	A1033
Ceramic Filter L (x10)	A1009
Heating Element	A1313
Front Holder	A1314
Packing	A1319
Element Cover	B1723
Nut	B1724
Filter Pipe	B2073

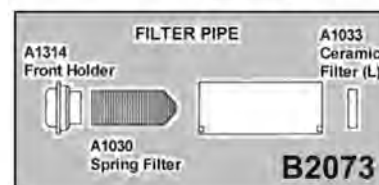
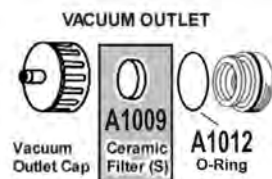
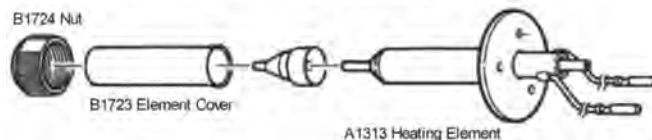



↓ Desoldering

SC7000Z MOTOR ACTUATED DESOLDERING PISTOL

The SC7000Z. It is a light weight, compact, pistol shaped device incorporating a built-in diaphragm type vacuum pump and 60 watt soldering iron. It is designed for general purpose field and workshop applications. (For heavy duty rework and production, see Hakko Re-work stations.) The combination of suction nozzle and trigger action increases efficiency and productivity. Also very effective on PCB's with through holes due to the direct heat and high suction power. The high power, ceramic heated tip is remote temperature sensed to give fast recovery and exact temperature control to prevent damage to IC, LSI and PCB tracks. Can also be used as a hot blow gun. Hot blow is suitable for removal of SMD components, heat shrink, etc.

Code
SC7000Z



Replacement Tips

See Manual

CODE NO.	SPEC.	STAMPED	φφ#	φD1	φD2	Lmm
50-01-11	0.8Std	0.8	0.8	2.5	7.0	12.5
50-01-12	0.8SLIM	0.8S	0.8	2.0	6.0	14.0
50-01-13	0.8U SLIM	S8	0.8	1.5	5.0	11.5
50-01-14	1.0 Std	1.0	1.0	2.5	7.0	12.5
50-01-15	1.5Std	1.5	1.5	3.0	7.0	12.5
50-01-16	1.0 SLIM	10S	1.0	2.0	6.0	14.0
50-01-17	1.5 SLIM	15S	1.5	2.2	6.0	14.0



SC7000Z TIPS, ACCESSORIES & SPARE PARTS

Description	DIAG	Code
Stand to suit	-	ST800
Tip assembly 0.8mm	1	SIT80
Tip assembly 1.0mm	1	SIT100
Tip assembly 1.5mm	1	SIT150
Heater holder	3	70-03-00
Heater assembly	6	70-06-50
Heater protector	6A	70-06-10
Pipe setter	7	5000A-7
Filter Cartridge(5pcs)	8	70-08-00
Rear Seal	10	70-10-00
Rear Pipe Setter	11	70-11-00
Diaphragm		70-26-00
Isolation Rubber		70-29-00
Gasket	19	70-19-00
Set Valve	22	70-22-00
MAIN PCB	37a	70-37-50
Power PCB	37b	70-37-51
Cleaning Pin	40	5000-51
Cleaning Pin Set	51	70-51-00

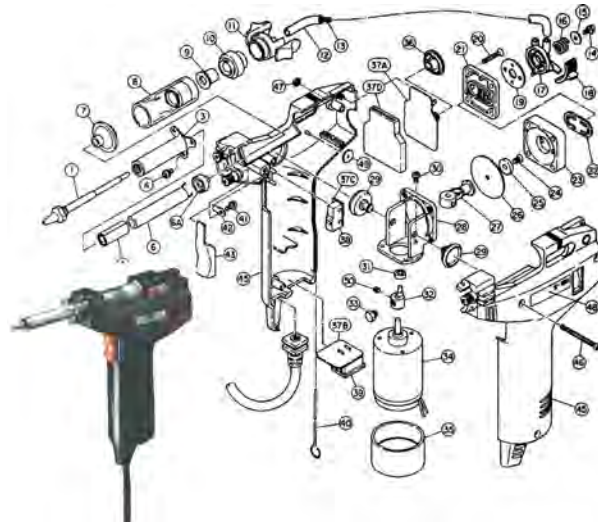

SC7000Z SURFACE MOUNT DESOLDERING AND REMOVAL KIT

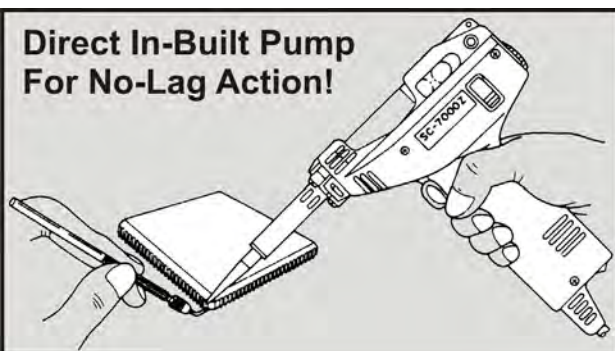

Surface Mount Device Removal Kit. Special Tip and assorted tools to suit SC7000Z.

Code
DICSMDBKIT



↓ Accessories

HAKKO SMOKE ABSORBER

PROFESSIONAL GRADE FUME EXTRACTOR

Safe work environment. Remove toxic fumes, etc. Suitable for commercial use. Electrostatic-Safe. Low noise fan. Stands upright or low-profile flat. Replaceable Filter: Urethane foam with refined activated carbon filtering. Removes toxins & particles for a cleaner & safer working environment at 1M³/min. Premium grade unit. Quality Made Hakko. 165x215x115mm

Code
FA400



EXTRA CARBON FILTERS

Order one to receive five. 130mm² Carbon Filters.

Code
A1001

DUAL OUTLET SOLDER FUME EXTRACTOR

HAKKO FAN & FILTER UNIT

Removes 99.97% of Hazardous Fumes. Low Noise Level, Lightweight. Portable with Flexible Ducting. Long Life Dc Brushless Motor. 3 Speed Air Flow Selector. 3 Stage Filtering, Pre-filter, Main and Carbon Filter. Led Indication, Pre-Filter and Main Filter Condition. Included: Main Unit, Pre-filter pkt of 10 and Main filter

Code
FA430

Requires Nozzle:



DUCTING KIT RECTANGULAR NOZZLE

Code
HK1571

DUCTING KIT ROUND NOZZLE

Code
HK1572



FUMINATOR - FUME EXTRACTOR

10cm Ultra-Quiet Fan with a two filter system. Activated carbon filter plus and a unique second rotating particle filter for a "8 times better filtering than a stationary only". Ultra-quiet in operation. Creates a safe and healthy working environment. Fully adjustable neck. Large 147mm metal base with solder holder. Premium grade made in the USA.

**DUAL CARBON FILTER SYSTEM
With Rotating Particle Filter**

Code
FXF11

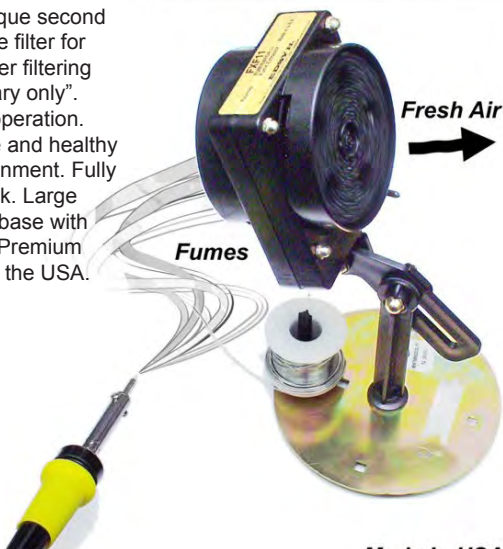

Made In USA

REPLACEMENT FILTERS X5

Ø	Code
88mmØ	XF02
92mmØ	XF03



↓ Solder

LEAD-FREE SOLDER

Made from a patented formula alloy that is environmentally friendly and without harmful toxins. Also uses a natural rosin core flux. Use lead-free solder and look after the environment and yourself! Melts 227°C. No performance loss.



Ø	Weight	Code
.3mm	200g	LFS203
.3mm	500g	LFS503
.5mm	200g	LFS205
.5mm	500g	LFS505
.7mm	200g	LFS207
.7mm	500g	LFS507
1mm	200g	LFS210
1mm	500g	LFS510

SOLDER PENCIL 17g

17g of 1.0mm solder.

Code
LFS171

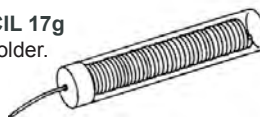

GENERAL PURPOSE 60/40 SOLDER ROSIN CORE

0.5mm 100g

Code
RS105

0.8mm 200g

Code
RS208

0.8mm 500g

Code
RS508

1.0mm 200g

Code
RS210

1.0mm 500g

Code
RS510



SOLDER PENCIL 17g

Resin cored solder in handy dispenser.

Code
RS171

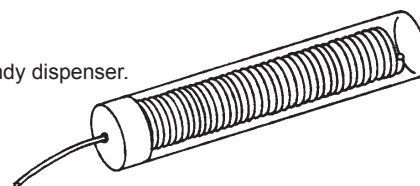

SOLDER PENCIL

Solder in a handy dispenser.

Type	Size	Weight	Code
Lead-Free	1.0mm	17g	LFS171
Rosin Core	1.0mm	17g	RS171





↓ Accessories

SOLDERING IRON STAND

Metal Base & Spring.
Standard Iron Size.

Code
HTA5



HTA5 Sponge

Code
SPG3455

SOLDERING IRON STAND

Heavy cast Base.
Standard Iron Size.

Code
HTA10



HTA10 Sponge

Code
SPG5052

IRON TIP CLEANER

Metal bin with a metal alloy sponge. Clean tips without losing temperature and as a result, tips last longer.

Code
HK599B



REPLACEMENT WIRE

Metal Sponge

Code
RW599

CLEANING SPONGE

Formulated to suit this application.

Size 34x55mm

Code
SPG3455

Size 50x52mm

Code
SPG5052

Hakko HK900+

Code
A1042

Hakko HK950

Code
A1386

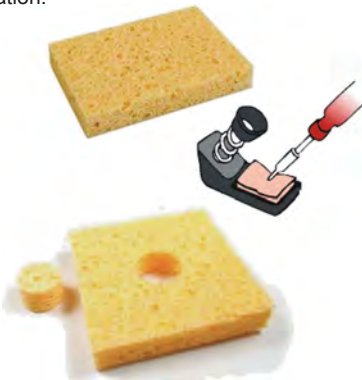

HAKKO ESD SOLDER HOLDER

SOLDER REEL STAND

ESD Safe. Weighted 650g.
All metal construction.

Code
HT1504



HAKKO OEM REEL

Code
HK611-1

DOUBLE OEM REEL

Code
HK611-2



MENDA FLUID DISPENSERS

Designed to be used with evaporative or dangerous fluids. Simply push down & a measured amount is transferred to the top to use as required. Made of high density polyethylene and is suitable for alcohol, ether, acetone, M.E.K, polish remover, flux remover, stripper, thinner, etc., etc. Stable. Sturdy. Available as standard cap or with locking cap for easy transportation. H80 X W50 X W50mm. (200ml)



Description	Code
Standard	MENDA612
Locking	MENDA712

SYRINGE BOTTLE - EMPTY

Squeeze to "eye drop". Suitable for non-volatile, flux, cleaner fluids, etc. Opaque plastic bottle Squeezable to inject Metal tip syringe top
Supplied empty

Holds	Code
55ml	BOT55E

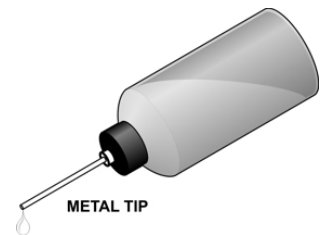

FELT-TIP DISPENSER

Just like a felt tip pen! Supplied empty with a push-to-release flow tip. Re-usable, cleanable tip. Suitable for accurate dispensing of flux, etc.

Size	Code
140x14mm	PEN200



FLUX TO SUIT

Size	Code
55ml	BS550

FIBRE PCB TRACK CLEANING PEN

ABRASIVE ENAMEL PCB CLEANER

Clean PCBs at the track level eliminating micro-fractures and other general repair diagnosis and inspection. Removes enamel covering leaving the bare copper.

Code
PEN220



REPLACEMENT TIPS

Code
PRF221

SOLDER PENCIL

LEAD FREE

No Toxic Soldering
Environmentally and Human friendly.
Handy dispenser &
No touch clean.

Size	Roll	Code
1.0mm	17g	LFS171

RESIN SOLDER

Handy dispenser.

Size	Roll	Code
1.0mm	17g	RS171





↓ Accessories

SOLDERING AID HAND TOOLS

Contains 6 double sided hand tools designed to help solder re-work professionally & quickly. Suitable for SMD, etc.

Code
SA10



SMD PICKUP TOOL

HAKKO ESD HAND TOOL

Helps lift & remove SMD ICs, etc. ESD Handle with Small wire.

Code
B1438



B1438 Pick Tool
Small Wire Inc.



B1439
Small Wire

B1440
Large Wire

REPLACEMENT WIRE

Type	Code
Small	B1439
Large	B1440

SMD REMOVAL KIT

LOW TEMPERATURE SOLDER

Kit includes enough solder for about 8 to 10 removals. Patented formula solder for Low Temperature Soldering offers less stress on delicate devices and due to a longer molten time, makes work easy. Economical solution compared to Air Blow Rework Stations. Flux and Instructions Inc.

Code
SMD1



Chip-Quick®

PASTE WITH SOLDER

AIM NO-CLEAN SN63 293+

Excellent wetting alloy paste Suits airflow solder rework Easy applicator 30g syringe Mildly activated resin based 63% Tin / 37% Lead formula Suits standard air reflow Enhanced printing & stencil use with improved idle times Low residue. Aqueous cleaner. Premium Australian made.

Code
293SN63



CONDUCTIVE PEN

Draws fine lines of conductive silver for design & repair of surface mount, standard & membrane type circuits. Self cleaning tip for smooth, highly conductive silver traces.

Standard Tip

Code
CW2200STP



FLUX IN A BOTTLE

"NO CLEAN LIQUID FLUX"

Assists with soldering For refilling dispensers Solvent rosin activated Non-corrosive residues Non-hygroscopic residues (removes with saponifier) Tested MIL-STD-F14256

Size Code
55ml BS550



SOLDERING PASTE [FLUX]

Paste in a metal tin Excellent solution for SMD Rework to General Heavy-Duty soldering work. Thick N pasty.

Weight Code
100g ZD170



FLUX SYRINGE

SOLDERING FLUX

Resin paste flux Multi-core 450-01 Rework SMD with this easy apply 10cc syringe. Contains resin. High grade quality.

Size Code
10cc FLX450

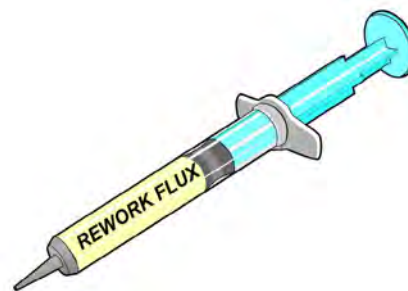

SILVER CONDUCTIVE PAINT

Dries to leave a conductive path. Suit PCB repair & connections to non-solderable materials, repairs rear demisters, etc. Excellent adhesion & conduction properties. Simply paint on!

Size Code
3g Phial SCP03B



CONDUCTIVE EPOXY GLUE

SILVER ADHESIVE

Provides strong, highly conductive silver connections for solderless component bonding, trace repair, grounding & shielding.

Two-part application for curing to high strength bonding.

Code
CW2400

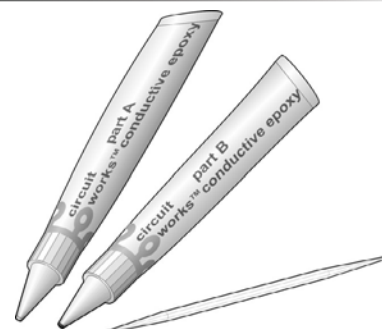



↓ Desoldering

COPPER WICK

NO-BRAND COPPER WICK

Width	Size	Code
2.5mm	1.5M	CW5

SCOPE DISPENSER WICK

Windback dispenser. 2M
Wick. Save fingers.
Metal tipped nose.
Scope brand quality

Size	Code
2mm wide	SB2
3mm wide	SB3

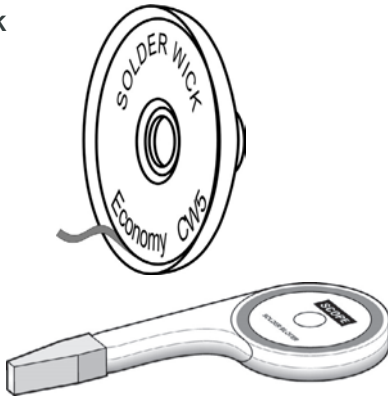

SCOPE TECH-WICK® DESOLDERING BRAID

Width	Length	Code
1.5mm	1.5M	STW1.5
2.0mm	1.5M	STW2
3.0mm	1.5M	STW3
3.5mm	1.5M	STW3.5

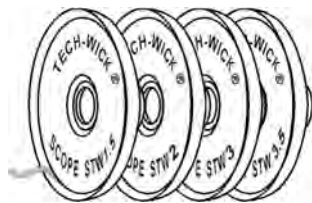

CHEM-WIK® LITE DESOLDERING BRAID

Quality Desoldering Braid Manufactured in USA

Width	Length	ID Colour	Code
1.3	1.5M	Yellow	CHEM5-5L
2.0	1.5M	Green	CHEM7-5L
2.5	1.5M	Blue	CHEM10-5L
1.3	7.6M	Yellow	CHEM5-25L
2.0	7.6M	Green	CHEM7-25L
2.5	7.6M	Blue	CHEM10-25L

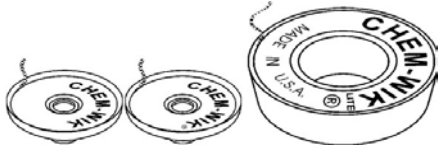

SODER-WICK® DESOLDERING BRAID

Quality Desoldering Braid manufactured in USA

Width	Length	ID Colour	Code
1.5mm	1.5M	Yellow	SOD50-2-5
2mm	1.5M	Green	SOD50-3-5
3mm	1.5M	Blue	SOD50-4-5
1.5mm	7.6M	Yellow	SOD50-2-25
2mm	7.6M	Green	SOD50-3-25
3mm	7.6M	Blue	SOD50-4-25

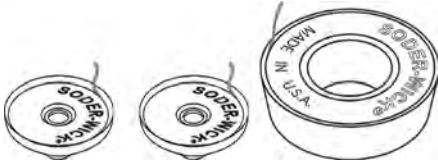

HAKKO WICK DESOLDERING BRAID

HAKKO® Made in the USA

Width	Length	Code
0.6mm	1.5M	HAK100
0.9mm	1.5M	HAK101
1.5mm	1.5M	HAK102
2.0mm	1.5M	HAK103
2.5mm	1.5M	HAK104
3.0mm	1.5M	HAK105
1.5mm	30M	HAK302
2.0mm	30M	HAK303
2.5mm	30M	HAK304

HAKKOWICK



EDSYN SOLDAPULLT ORIGINAL ES SUCKER

Popular original USA, Metal barrel. Lightweight. 250mm.

Code
SS350



REPLACEMENT TIP

Code
LS363

O RING

Code
OS130

SOLDER-SUCKER DESOLDERING TOOL

For general PCB desoldering work. 230mm length.

Code
SS104



REPLACEMENT TIP

Code
SRT104

O RING

Code
ODS100

EDSYN SOLDAPULLT ORIGINAL ES SUCKER

Heavy duty original USA safety sucker. 330mm Long

Code
DS017LS



REPLACEMENT TIP

Code
SRT12

O RING

Code
ODS31

ANTI-STATIC TIP

Code
LS197

ESD DESOLDERING TOOL

Heavy-duty PCB desoldering. 330mm long. Large capacity. Teflon tip. Safety plunger. China.

Code
SS108

TIP

Code
SRT108

O RING

Code
ODS100



DESOLDERING TOOL "O" RING LUBRICANT

Ensure correct action just like new with better suction and reduced solder sticking.

Code
OL111





→ ESD

ESD FIELD SERVICE KIT

PORTABLE SOLUTION FOR REPAIRERS

The tough, long lasting work mat 600 x 600mm with storage pockets and accessories. Folds easily for transportation. This field service kit comprises of one mat, a 5 Metre earth lead, and a Wrist band with 2 Metre cord. Durable, non-rip, portable ESD rework station for protecting the operator and equipment during re-work, etc.

Code
ASK110

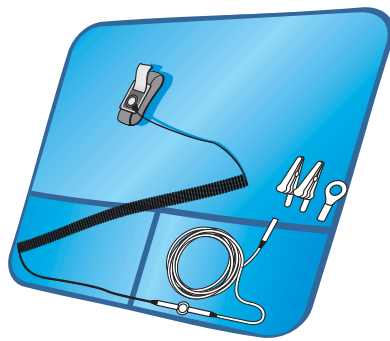

ESD MAT & WRIST STRAP

DESKTOP ESD MAT SOLUTION

Thick, durable high grade mat. Non slip blue-grey rubber ensures the mat and appliance will not move inadvertently. High quality construction. Chemical & heat resistant. Includes wrist strap.

STANDARD 400 x 600mm

Code
ASK120

LARGER 600 x 1000mm

Code
ASK160



ESD MAT BULK

STATIC DISSIPATIVE MAT 10M

As used in the ASK120 / 160 2 Layer Static Dissipative High grade synthetic rubber. Non-slip, Non-tear, Anti-glare, Chemical, heat and abrasion resistant structured surface. Excellent desktop and bench workshop fit solution. Save. EOS/ESD-#4.1 EIA-625 MIL-HDBK263 STD-1686

Size Code
60cm ASM610



Stud Connect NOT Included See Below

ESD WRIST BAND

SOFT CLOTH TYPE WITH CORD

Fully adjustable with extra operator comfort. Built in protective 1MΩ resistor and press stud. Includes a 3M coil cord terminates to a banana plug with alligator clip. Connects to ESD mats or chassis, etc.

Code
ASW115



ESD MAT ACCESSORIES

MALE STUD & SCREW

10mm snap for ground cord. Screws. No crimp required.

Code
ASM10

COMMON GROUND CORD

Benchtop ESD mat solution. 10mm female snap for stud. 4.5M long. Built-in 1MΩ. Accepts 2x 4mm banana.

Code
ASG452



STUD ONLY
Mat Not Included

LEAD & CONNECTOR
Mat Not Included

ESD HEEL STRAP

Conductive ribbon shoe grounding system to accommodate all sorts of footwear using fully adjustable velcro straps. Connection is made via the tough black conductive rubber under the heel and a comfortable conductive cloth strap that is simply tucked into your sock. 1MΩ resistor is in the loop for safety. Convenience. Requires floor ESD mat

Code
ASH120



ESD - EARTH

ESD EARTH PLUG

Suitable for eliminating Electro-Static from units during repair, earthing a work bench, etc. Approved. Green.

PIGGY-BACK PLUG

Code
ACP463AS

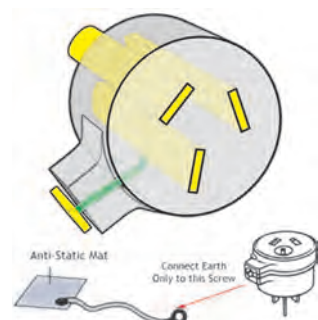

Anti-Static Mat
Connect Earth Only to this Screw



↓ Television and Monitor

HIGH VOLTAGE PROBE

Allows voltages up to 40KV to be measured. Its main purpose is to measure the anode voltage of picture tubes or microwave oven magnetrons, etc. Input impedance 1 GigaOhm (Approx.) Output impedance 1.1 MegaOhm. Meter should be 10M input at least. Max V 40KVdc, 40KVac, 28KVrms. Accuracy 1KVg20KVdc ±1%
 20KVg40KVdc ±2%
 1KVg15KVrms ±2%
 15KVg28KVrms ±3%

1000:1 Ratio.

Code

HV40



CRT DEGAUSSING WAND

This powerful wand does the job right the first time, every time. Manufactured in Australia and it plugs straight into 240V.

Code

XT8150

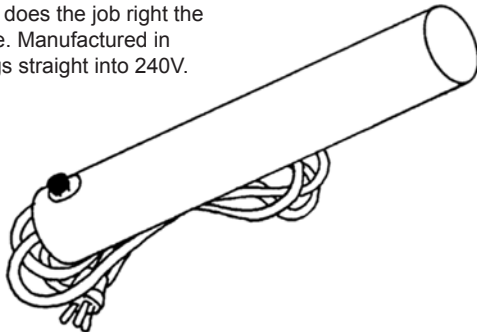

L.O.P.T. TESTER

This handy instrument will simulate the horizontal output section of a TV to accurately test LOPT's and Diode Split Flyback Transformers. 90 & 110°. By connecting two leads to the primary and monitoring the HV lead output, a reading in Kilovolts is given.

An LED will alert to any problem and a fault code will appear on the display to confirm your diagnosis. A fully professional unit, comes with instructions and the Diemen CD-ROM cross-reference for pin outs, etc.

Code

STVDST01



LCD BACK LIGHT TESTER FOR CCFL LAMPS

Make servicing large LCD TV's and monitors easier and faster using the new DIEMEN's CCFL Lamp Analyser. Test the panel-mounted lamp without having to dismantle the entire PANEL and without having to unplug the different connectors that are interacting between the inverter plate and lamps. The Analyser will then indicate whether the Lamp is faulty and needs replacing or if the LAMP is working or other fault in most cases the inverter board will be the cause of the fault and needs to be replaced. Includes 12V DC power supply.

Code

TL1040



↓ Isolation Transformers

POWER MAINS ISOLATOR

Isolation transformer for protecting yourself from the 240Vac mains. Ideal for TV repair of mains chassis units. Allows connection of CROs to equipment. Essential for the technicians bay.

Current Code

1 AMP TDB240-240

2 AMP TDB240-500

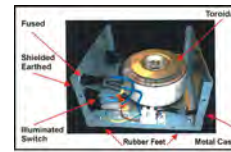

FOR TECHNICIANS
HIGH VOLTAGE
 PROTECT YOURSELF



High Efficiency Low Noise Toroidal Transformer

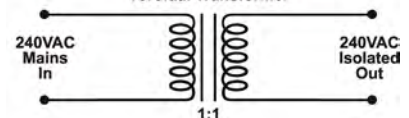

VARIAC

VARIABLE AC SUPPLY

Adjust the output of your mains for testing and diagnostics, etc. !! WARNING !!

This is not an isolation transformer. Mains thru. Neutrals are common. "Auto-Transformer"

PROFESSIONAL VERSION

For bench hard wiring, etc.

Current Code

2A VRC2

4A VRC4

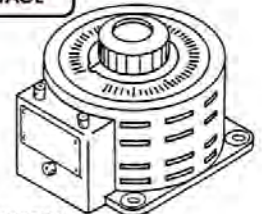

FOR TECHNICIANS
HIGH VOLTAGE
 TEST PLATFORM FOR REPAIRING

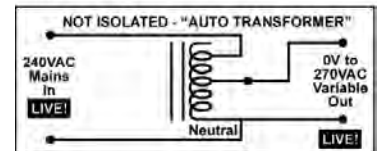

VARIAC

AUTOTRANSFORMER

Not an isolation type!
 If repairing Live Chassis An isolation transformer should be used for safety. Variable mains transformer. Outputs 0Vac to 260Vac. Maximum power is 500V/A. Toroidal transformer with mechanical wiper that will vary the AC Voltage output. Includes fuse and switch. Includes voltage meter. Input/output mains lead.

Current Code

2A MP3080





↓ Pattern Generators

PC & HDTV ANALOGUE PATTERN GENERATOR

HD-15 VGA & COMPONENT OUTPUTS

27 Test patterns selectable by OSD for monitor testing. Analogue RGBHV or YUV out. Refresh 50, 60, 72, 75, 85Hz. VGA g S-XGA 1280x1024 Res HDTV 480p 576p 720p 1080i Component RCAX3 Lead inc. D-Sub Lead inc. Compact metal cabinet. Suits LCD, PDP, CRT, Monitors or projectors. Includes 5Vdc P/Pack.

Output	Code
VGA & YUV	CPA-1

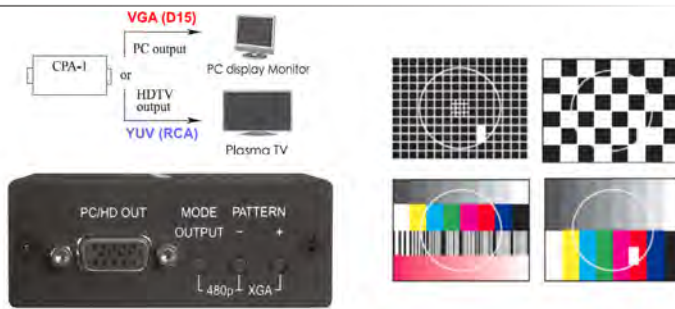

PC & HDTV DIGITAL & ANALOGUE PATTERN GENERATOR

DVI INTEGRATED

27 Test patterns selectable by OSD for monitor testing. Digital only output DVI-D. Refresh 50, 60, 72, 75, 85Hz. VGA g S-XGA 1280x1024 Res HDTV 480p 576p 720p 1080i Compact metal cabinet for portability or desktop. DVI Connector & Lead inc. Powerpack Inc. Suits LCD & Plasma Monitors or projectors. Excellent solution for installation & repairs, etc.

Output	Code
DVI-I	CPA-2

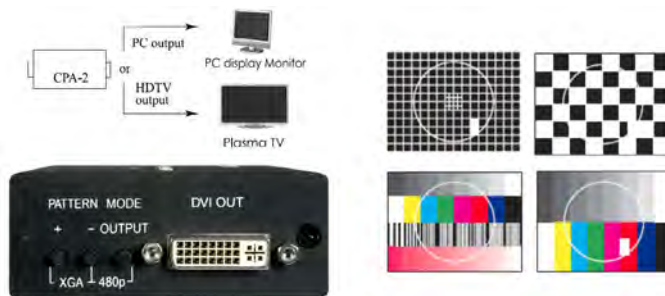

VIDEO PATTERN GENERATOR DIGITAL

HDMI PC & HDTV TIMING

Supports HDCP signal verification pattern.
 On-panel LED display and LED indicators. Remote control.
 • HDMI v1.2, HDCP1.1 and DVI1.0 compliant 1.65Gbps (single link).
 • Output Resolution: 720p50 / 720p60 / VGA60
 • Output Signal: DVI / HDMI / Auto Detect
 • Patterns: 8 Groups with 35 patterns
 • Audio: Internal 1 kHz Sinewave Stereo
 • Audio: Internal 1 kHz Sinewave Stereo
 • Audio: Internal 1 kHz Sinewave Stereo
 • EDID support: VESA EDID v1.3 and EIA/CEA 861 Version 3.
 • Output: HDMI female port (type A connector) x1

Output	Code
HDMI 1.2	CPA-3



VIDEO PATTERN GENERATOR DIGITAL MOTION

HDMI WITH MOTION BLOCK

This is a wide variety of PC and HD pattern for stable test signals. Use the keypad or remote control to select patterns and timing.
 • On-panel LED display and LED indicators.
 • Remote control.
 • HDMI v1.2, HDCP1.1 and DVI1.0 compliant 1.65Gbps (single link).
 • PC Mode: VGA60, SVGA60, XGA60, SXGA60, UXGA60, WUXGA60.
 • HD Mode: 576p-50, 480p-60, 720p-50/60, 1080i-50/60, 1080p-50/60.
 • Output Signal: DVI / HDMI / Auto Detect.
 • 8 Groups with 36 patterns. With Motion block.
 • Audio: Internal 1 kHz Sinewave 48kHz Multiple Channel (up to 8)
 • HDCP Verify. EDID support: VESA EDID v1.3 and EIA/CEA 861 V3.

Output	Code
HDMI 1.2	CPA-4

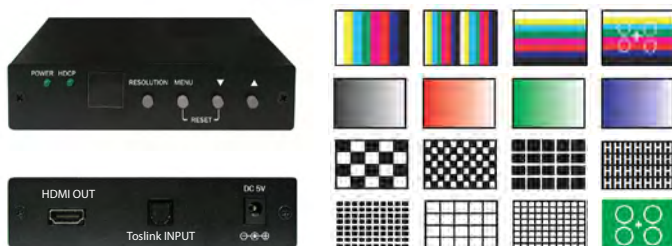

ANALOGUE RF OUTPUT PATTERN GENERATOR

PORTABLE SOLUTION

Compact unit includes full field colour bar, stair case & cross-hatch patterns for convergence.
 1KHz Audio tone.
 RCA Audio/Video and "F" RF CH36 output.
 625 lines/50Hz Pal.
 15625Hz Interlaced.
 7.5Vdc Power Pack & RF & RCA cables INC.
 PAL RF & RCA OUT

Output	Code
RF	CG-200R

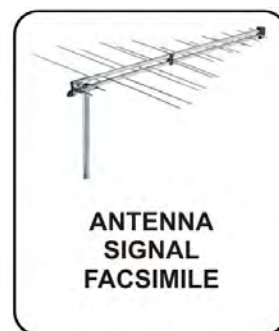



↓ Pattern Generators

3D MINI HDMI ANALYZER

HDMI SOURCE ANALYZER

Checking both source and display devices. LED can show status of both input and output device. The major purpose is to analyze input source info-frame and output sink EDID.

Another purpose is to use built-in pattern to test output device.

- Supports Timing include SD, HD up to 1080p, PC up to WUXGA and 3D
- Provides 25 timings and 6 patterns
- Deep color video up to 36 bits (12bits/color), 1080p@60Hz
- Lossless compressed (Dolby TrueHD/Plus and DTS-HD master Audio)
- Supports internal pattern audio LPCM 2.0/5.1/7.1CH 48/96/192KHz
- Analyze input source info-frame and output sink EDID
- Touch button control function
- OLED show Input / Output timing information.



Output	Code
HDMI 3D	CH-A1

MULTISYSTEM TV PATTERN GENERATOR

MULTISYSTEM TV PATTERN GENERATOR

- Built-in On Screen Display indicates the TV system of the output pattern.
- Fourteen test patterns; Circle, 8-step Grey Scale, 16-step Grey Scale, Color Bar, Multiburst, Color Difference R-Y, B-Y, Moving white Field, White Pattern, Checkerboard, Crosshatch, Dots, Center Cross, and Purity Patterns.
- Over 100 test patterns are available through the combination of 14 patterns.
- Multiburst pattern comprises full screen definition pattern of 8 vertical bars
- Frequencies of 0.1-1.8-2.8-3.0-3.4-3.8-4.8 MHz.
- Four speeds for the Moving White Field for testing fast motion picture.
- Multi-system output: NTSC 3.58, 4.43, PAL, PAL M, PAL N, and SECAM.
- Output: Composite video, Y/C Separation, Color Difference Y, R-Y, B-Y.

Output	Code
Analogue	LPM55



ANALOGUE & HDMI V1.3 PATTERN GENERATOR

SOPHISTICATED TEST INSTRUMENT WITH SOURCE ANALYZER

This HDMI v1.3 compliant video test pattern generator is the most advance device for your audio & video signals test. With built-in 39 timings and 45 patterns, it outputs both analog and digital signals. LCD screen for easy viewing. Also check the resolution of your devices and record them, check bandwidth and phase behavior of video transmission, verify video amplifiers/color temperature/ video motion plus HDCP verification, data comparison, EDID check and many more other useful functions. Professional grade instrument.

- HDMI 1.3 , HDCP 1.1 , DVI 1.0 compliant.
- Timings include SD, HD up to 1080p, PC up to WUXGA.
- Output format are digital HDMI/DVI, or analog PC/HD(component).
- Deep Color supports 8 / 10 / 12 bits.
- User-friendly interface - LEDs, LCD display, IR remote, RS-232 remote.

Output	Code
HDMI V1.3	CPHD-3



↓ Test Discs and Tapes

VCR TEST TAPES

SEE-THRU CASSETTE

Dummy tape for VCR repair.

Code
VID5041

GP VHS TEST TAPE

Colour bar.

Code
VID50

PRECISION VHS TAPE

Master copy. Premium Q.

Code
VID70

HIFI ALIGNMENT TAPE

Includes picture tests.

Code
VID75





↓ Signal Strength

CB-RADIO VSWR & POWER METER

1.8MHz-525MHz 200W max. Measures SWR and POWER for optimum antenna tuning, etc. Peak-Envelope-Power SSB Mode or Average.

Transmitted & Reflected Power, switched. Requires 12Vdc (DC lead inc.) or Optional 240V PowerPack Two pair of PL259 connections for 1.8 → 180MHz & 140 → 525MHz. Power 5W 20W 200W 400W Ranges Semi-Professional full featured Large scale meter display. 50W 1GL 1Bz 50F 150x65x100mm Benelec 0301

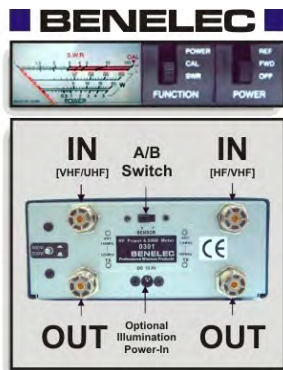

Code
VSWR0301



SATELLITE FINDER - PRO

PROMAX with TONE
950MHz to 2050MHz Meter
Audio tone for eyes-free
Analogue -30dBm to +5dBm
Power-Thru "F" to "F" With
Voltage meter too Premium
Promax device

Code
MS250



SATELLITE FINDER

DAI-1CHI
Connects inline with the cable.
Has 2 x "F" connector sockets
Frequency range 1GHz-1.6GHz.
Dai-1chi brand general purpose.

Code
SAT2100



TV SIGNAL LEVEL METER

GRAETZ HAND-HELD
Digital display analogue TV Signal levels to 0.1dB. Pre-programmed to AU/NZ. Measures Audio & Vision DCP, A/V Ratio, noise ratio CATV trunk-line voltage. Tunes Channel or Freq. 30 to 115dBµV or dBm. Freq Range 46-870MHz. RF Input "F" connector. Internal rechargeable. Inbuilt loudspeaker. Audio demodulation. Heavy-duty protected. Not for DVB.

Code
TC870C



DVB-T TERRESTRIAL METER

ANALOGUE & DIGITAL
Optimize test and measurement of complete Digital and Analogue television reception systems. Useful in the field or a laboratory, from antenna alignment through MATV systems to broadcast.

- Modulation Error Ratio (MER) total quality quantification.
- Bit Error Ratio (BER) before Viterbi corrector.
- Bit Error Ratio (BER) after Viterbi corrector.
- Damaged packet count, after Reed-Solomon
- A powerful signal evaluation tool.
- Lock signal sync. indicates service found.
- Digital channel Signal Level in Power.
- Analog Video and Audio Carrier Levels,
- Vision to Audio / Carrier to Noise ratios.
- PC Software provides extensive graphical and operational functions:
- Spectrum Analysis, Data Logging, Signal monitoring and detailed Constellation diagram. Export graphics etc. into Excel and Word.

Code
DAT102



DVB-S SATELLITE METER

MAXPEAK SAM-LITE
Battery powered hand held satellite alignment meter. It powers the LNB and is pre-programmed from the web via built in USB. All difficult tasks like programming and difficult menu or operation is eliminated. Extremely fast and accurate with high sensitivity. Worlds first low cost satellite identifying meter.
C, Ku, Ka or L band
Replaceable F-connector
75 Ohm 30 to 100 dBV (-75dBm)
RF level as dBuV displayed with Quality in % (reverse BER)
www.maxpeak.tv

Code
SAM-LITE



DVB-S2 SATELLITE METER

MAXPEAK SAM-PLUS
Battery powered hand held satellite alignment meter. It powers the LNB and is pre-programmed from the web via built in USB. Unique touch wheel to access all functions. All difficult tasks like programming and difficult menu or operation is eliminated. Extremely fast and accurate with high sensitivity. Works with DVB-S as the latest DVB-S2 e.g. QPSK, 8PSK, MPEG2 and MPEG 4. Developed for DTH & the VSAT market. www.maxpeak.tv

Code
SAM-PLUS





↓ Signal Strength

TV SIGNAL STRENGTH METER

TV SIGNAL FINDER

Digital TV signal strength Finder. Powered by 9V batteries (not included) or via set top box. LED display to indicate the strength. F connector to connect the signal cable. Built in amplifier compensates insertion loss. Pocket size and lightweight. Suitable for analogue and digital application.

Code
AITVF



DIGITAL SATELLITE SIGNAL QUALITY FINDER

PORTABLE DIGITAL SATELLITE SIGNAL FINDER

Instrument is designed to Find any AURORA, VAST or SELECTV when selected. Satellite meter is powered via external power supply or set top box. F connector to connect the signal cable. Audible beeper. LED Display for Signal Strength & Quality. Kit includes Compass, battery Box, Charger, Car Charger and Hands Free wrist strap.

Code
SQ701



↓ Communication

BUTTINKSI TELEPHONE

TECHNICIANS TEST PHONE

Safe and protected
Linemans handset
Drop-proof rugged design
Tone (DTMF) dialling.
Pulse (decadic) dialling.
Last number re-dial.
Monitoring (high Z).
Ringer with switch.
Metal Belt hook.
2 x RJ12 sockets
for line connection

Code
TS9000

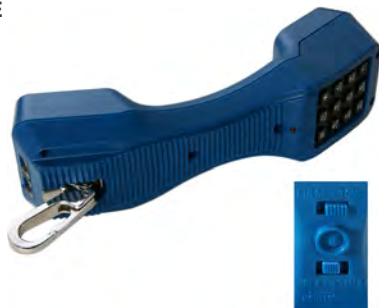

CORD TO SUIT

1 x Double Socket Extension.
1 x 1.0M RJ12–RJ12 lead.
1 x 0.3M RJ12–RJ12 lead.
1 x 0.3M RJ12– Two Pole
Krone style plug.

Code
TS9003



↓ Miscellaneous

MICROWAVE LEAKAGE MONITOR

Detect and measure 2450MHz microwave leaks from door seals, etc. 3 Digit meter 0 to 9.99mW/cm² with a 5mW/cm² alarm. +/-1dB accuracy. 160x60x42mm hand-held instrument. Max-Hold. Zero set. Back light. Includes protective carry pouch. Requires 9V battery.

Code
DT2G



EMF TESTER

ELECTROMAGNETIC FIELD RADIATION TESTER

The EMF tester is a quick, convenient reliable way to determine EMF radiation levels from electrical equipment, power lines, monitors, industrial machines, etc. Measurement ranges 20µ 200µ 2000µ Tesla, max resolution of 10pT (10 milli-Gause). Also known as EMR (ElectroMagnetic Radiation) For specifics on exposure levels please enquire with the EPA (www.epa.nsw.gov.au) or Radiation Protection Agency (www.arpana.gov.au). AU Recommended "Home 100µT" and "Work 500µT". Two styles of meter available. 9V Bat' Req'.



BUILT IN SENSOR

Place the head of the meter on or at the radiation source.

Code
EMF823

EXTERNAL PROBE

Same meter but with a directional probe.

Code
EMF827



DIGITAL THERMOMETER

Portable, and handy pocket sized four digit digital display thermometer. Detachable Stainless steel probe that includes 1M of cable. Ideal for all service applications such as Heating and Ventilation systems, Agriculture, refrigeration and Laboratories. Built in table stand and pocket clip. Fast (1 second) or Slow (15 seconds) temperature measuring cycle options. Adjustable High and Low temperature warning / alert alarm. Wide Temperature reading: -40°C to +50°C Resolution: 0.1, max. 0.3

Code
BC203T



LABORATORY
GRADE
THERMOMETER





↓ Appliance

PORTABLE APPLIANCE TESTER KYORITSU

As part of the OHS laws in Australia (that may vary between states) it is required to regularly check power cables, power boards and appliances such as electric power tools, microwave ovens, plug-in air conditioners, toasters, vacuum cleaners, computers, etc. to ensure that the equipment is electrically safe. The Kyoritsu 6201A is hand-held portable appliance tester that ensures the Safety of Class I and Class II appliances and power leads for Leakage Current. A large LCD displays the mains voltage, plus other functions. 4 LED indicators and buzzer sound identifies if each test has passed or failed. Fuse protected. Includes Mains cord, Test lead with safety alligator clip / probe attachments & Extension lead test cable. Made in Japan. Pass / Fail Stickers Not Included. See Below.



KYORITSU
JAPANESE QUALITY

Code
AT6201A

PASS / FAIL STICKERS

On completion of each test of the appliance / cable it is required to be labelled with a PASS or FAIL sticker that is filled in with identification details. Buy 1 to receive 250.

Code
FAIL-TAGS
PASS-TAGS

PORTABLE APPLIANCE TESTER AEGIS

Class 1 & 2 Approved

Earth bond and insulation tester. Australian designed and manufactured for testing electrical appliances to power electrical safety Standards of AS/NZS 3760. Compact, portable, drop & Weather Proof. Includes Leads, etc. Battery operated portable. 235x190x110mm. 6x "AA" inc.

Code
CZ5000

OPTIONAL LOG BOOK

Code
CZ5074

EXTRA TEST TAGS

Code
CZ5072

FAIL STICKERS

Code
FAIL-TAGS



- Does your business comply with the Australian and New Zealand Standard AS/NZS 3760 Electrical Safety?
- Are your electrical appliances tested and tagged on a regular basis?
- Fully Portable Battery Operated
- Drop Proof
- Weather Proof (IP67)
- Compact with all Leads and accessories, including a set of Test Tags, housed in the instrument case.



PORTABLE APPLIANCE TEST LEAKAGE ADD-ON

USE IN ADDITION TO CZ5000

Upgrades Appliance test to AS/NZS3760:2003 Leakage Current Measurement Tester when used with the CZ5000 unit above. Australian designed and manufactured for testing electrical appliances to power electrical safety Standards. Certified for the use as a Verification of insulation integrity of portable devices. ie, CZ5000 & CZ5500 required for the full AS/NZ3760:2003 Compliance Test. 3 LEDs show the level of the actual return current flowing through the earth conductor. Easy to use and cost effective. Premium grade professional AEGIS. Stickers extra.

Code
CZ5500



CZ5500 Thresholds
Insulation integrity verification, by measuring the return leakage current in the Earth conductor:
Threshold 1: 0 to 1mA
Threshold 2: > 1mA to 2.5mA
Threshold 3: > 2.5mA to 5mA
Threshold 3: > 5mA
 These thresholds are in line with the requirements of AS/NZS3760:2003
Green LED = Leakage Current is at or below 1mA.
Yellow LED = Leakage Current is at or below 2.5mA, but more than 1mA.
Yellow LED = Leakage Current is at or below 5mA, but more than 2.5mA
Red LED = Leakage Current is above 5mA.
 A warning buzzer with also sound when leakage current is above 5mA.



↓ **Miscellaneous**

SOUND LEVEL METER

LUTRON DIGITAL MEASUREMENT

This unit is designed to meet IEC651 type 2 testing standards. A premium audio level instrument Precision calibrated (Certified) with A & C Weighting (Filter), Fast/ Slow time response with Hold. Large 3½ Digit LCD Numeric Display 3.5mm output to analyzer, etc. Camera stand mount socket Includes a plastic carrying case Range: 80dB, 100dB, 130dB max Flat F' Range: 31.5Hz - 8KHz size: 225x70x28mm

Code
SL4011

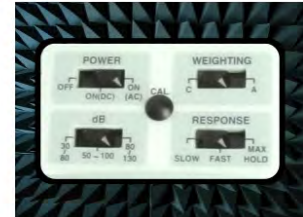

2.4GHz FREQUENCY COUNTER

PROMAX PROFESSIONAL DUAL

High grade test instrument as required for professional workshop repairs and alignments. Advanced circuitry allows precise measurement of signal levels between 10mV to 250V. Over voltage protection. Noise filter circuit (low pass). Gate time switching.

INPUT A

20MHz / 160MHz (switched) 15mV sensitivity 250V max.
1MΩ / 35pF Zin Low-pass switch for 20-20KHz only.

INPUT B

100MHz / 2.4GHz 10mV sensitivity 100V max 10MHz time base

Code
FD252



LASER POWER METER

LASER POWER METER

Konig of Germany. Suitable for the service on CD, DVD laser disc players. A narrow tiltable probe can measure all typical helium-neon & LED type lasers. Integrated load simulation for laser diode power supply.

Measuring ranges : 0.3mW, 1mW and 3mW.
Wavelength : Switchable 33nm, 750-820nm.
Batteries : 2x1.5v batteries (type SUM-3 1.5V).

Code
LPM5673



MOISTURE DETECTOR

2 IN 1 MOISTURE DETECTOR (WOOD AND BUILDING MATERIAL)

An Unique product to measure the moisture in Building material. Measuring range wood : 5%-50%.

Measuring Range Building Material : 5%-33%.

Audible Sound with 8 different Tones level.

Hold Switch : Freeze/Hold the reading.

Operating Voltage : 9V DC Alkaline Battery (Not Included).

Big LCD display.

Low Battery indicator.

Reading: 1.5% - 50%.

Resolution: 0.1%.

Accuracy: ±3%.

Code
MS-98J





↓ Meterman Amprobe Tools

METERMAN - AMPROSE - TEST EQUIPMENT

The Wavetek USA Meterman product line has now merged with Amprobe.

Amprobe, a well-known name in test equipment, offers all the products you used to know as Meterman plus its own full line of test equipment.

We stock a range of meters for their outstanding quality, reliability and accuracy, for the technician who demands total confidence from a measurement device.

All meters include "Safety" leads. Each multimeter has full function voltage, current and resistance, but also offer additional functions important to trouble shooting the electronics you work with.

www.amprobe.com



AMPROSE MINI-MULTIMETER

INDUSTRIAL GRADE 4 DIGIT 6000 COUNT

CAT-III rated Pocket compact 10mm thick mini-meter from the best. 4 Digit Auto-Range full featured. 6000 Count updates 5 times a second. One button function control. AutoTect: Fully automatic. Protected. VolTect: Non-contact high voltage detector for added personal safety. Supplied with protective silicone boot & carry case. Leads attached. The most advanced convenience in metering available today.

Measures:
AC/DC Volts (600V)
AC/DC current (2A)
Capacitance 2000µF
Frequency 30KHz
Resist. Diode. Buzz.

Code
PM55

EF VolTect
Electric
Field
Detection



**SUPER COMPACT
MINI-METER PRO**
113 x 53 x 10mm

AMPROSE POCKET DIGITAL MULTIMETER

Large 0.7" 3.5 digit display
Meterman XP Series combine features and accuracy CAT-III safety rating
2000 Count auto-ranging
Magne-Grip holster
Built-In Non-Contact Voltage detection!
Input warning beeper
Safety test leads
Continuity beeper
17 ranges inc. Diode test.
DCV(+/-0.8%) 200mV to 1000V
ACV(+/-1.2%) up to 500V
DCI(+/-1.2%) 200uA to 2A
And Resistance 200Ω to 2MΩ
155x72x32mm

Code
DM5XP



TRU-RMS PROFESSIONAL DMM - LCR

10,000 count 4 digit backlit display with analogue bar graph. Includes rubber holster, hanging strap, safety leads, etc. Full manual/auto-range. Peak hold, min max avg. Excellent component & logic test instrument. Field, factory or workshop. Relative and dBm ranges for easy CCT analysis. CMOS/TTL Logic test. DCV (±0.25%) 1000V
ACV True-RMS 750V
ACI/DCI 10A Ω (+/- 0.5%)
1KΩ g 40MΩ Frequency 10MHz
Capacitance 40nF g 400µF
Inductance 4mH g 40H
Continuity & Diode test.
Pro Grade from Meterman CAT-III, CAT-IV rated.

Code
DM37XR



Precision
Professional
Electronics

AMPROSE WITH LOGIC & ACI RANGES

Large 0.7" 3.5 digit display
Warning & continuity beeper Meterman XP Series combine features and accuracy CAT-III safety rating 2000 Count auto-ranging Magne-Grip holster
Built-In Non-Contact Voltage detection!
Safety test leads. logic probe, Diode test, AC/DC Current 29 ranges inc. DCV(+/-0.5%)
200mV to 1000V
ACV(+/-1.0%) 200mV to 750V AC/DCI(+/-1.2%)
200uA to 2A Resistance 200Ω to 2000MΩ
155x72x32mm

Code
DM15XP



TRU-RMS INDUSTRIAL DMM - RS232

10,000 count 4 digit backlit display with analogue bar graph. Inc. rubber holster, hanging strap, etc. A truly professional meter. Full manual/auto-range. Peak hold, min max avg. DCV (±0.25%) 1000V ACV True-RMS 750V
ACI/DCI 10A 4-20mA
Loop-I with %
Temp' -20°C g 1300°C Ω (+/- 0.5%) 1KΩ g 40MΩ
Frequency 10MHz
Capacitance 400µF
Continuity & Diode test.
CAT-III, CAT-IV rated.

Code
DM38XR

OPTIONAL RS232 INTERFACE
PC Interface with software.

Code
38SW



PC-LINK
Optional
Extra





↓ Meterman Amprose Tools

LARGE DURABLE WAVETEK CASE

PROFESSIONAL GRADE

Heavy-duty construction. Tough nylon material. Tear proof protection. Double lined and padded. Adjustable hand strap. Meter Leads compartment. Meter & Leads not included. Easily holds 100x40x200mm for Small medium or Large meters.

Size	Code
200x100x40mm	CA05A



OTHER METER CASES

Size	Code
135x65x25mm	CA04
190x90x50mm	CA03

↓ Analog Multimeter

ANALOG MULTIMETER

Large 4" Mirrored Meter. Extra Rugged, Safety Design Overload Protected element. FUSE & Diode Protected. Automatically, Simultaneous Transistor Type & Quality Check. Battery Tester Polarity Reversing Switch Accuracy within +/-3% full scale on all ranges.



AC/DCV 3/10/30/100/300/1000V
Sensitivity, 30KΩ per DCV 10KΩ ACV
DCI 100u/3m/30m/300m/10A
Resistance Rx1.0-1K (10 Ohm Centre)
Rx10 0-10K (100 Ohm Centre)
Rx1K 0-1M (10K Ohm Centre)
Rx10K 0-10M (100K Ohm Centre)

Code	HC3030
------	--------

↓ Other Multimeters

PEN DIGITAL MULTIMETER

PROFESSIONAL GRADE TOOL MADE IN JAPAN BY KYORITSU

Compact in Size, Light in Weight, Simple in Use and Full Featured! Double molding provides comfortable with good feeling in your hand. Built-In LED Penlight illuminates brightly the point to be measured. Backlight LCD display is highly visible, switchable for power save. Economical design & Auto power-off function saves the battery life. Unique wrapping mechanism for test lead in the rear side compartment. Unique retractable probe for tip protection mechanism and safety. EVERY range is fully protected against overload voltage of 600V. Conforms to International safety standards IEC61010-1:2001 CAT-III. 4000 Count For digit display shows a maximum reading of 3999. Autorange with manual select over-ride. Data hold for away reading. Includes Voltage (600Vac/dc) Ohms, Diode, Continuity buzzer, Capacitance (50n-100µF), Frequency (5Hz-200KHz), Duty Cycle (0.1%-99.9%), Battery status indicator, 190x40x30mm 100g (Inc Bat.)

Code	KEW1030
------	---------

↓ AC Clamp Meter

AC CLAMP METER ANALOGUE

KEW SNAP - KYORITSU

Easy to use and dependable, this instrument is designed to incorporate as many safety priorities as possible. Features a clamp meter that measures AC current 3A to 300A. Includes Safety leads for measuring ACV (Up to 600V), DCV (60V) and Resistance. Tear drop shaped jaws for use in crowded cable areas. Easy to read analogue display with locking feature to freeze needle for no-parallax reading. Very sturdy plastic case with a heavy-duty hard protective pouch. 20cm overall length. Requires 1x AA battery. Fuse protected. High quality for years of reliable service.

Code	CM2608
------	--------



AC CLAMP METER DIGITAL

KEW SNAP - KYORITSU

Easy to use and dependable, this instrument is designed to be safe and practical. This professional clamp meter. AC Current 0.1A to 600A. 40g1000Hz with high accuracy. Includes Safety leads for measuring ACV (Up to 600V), Continuity and Resistance. Tear drop shaped jaws for use in crowded cable areas. Easy to read 3.5 digit display with Data Hold feature to freeze the display for easy reading. Sturdy plastic case with a protective pouch. 22cm overall length. Fuse protected. High quality for years of reliable service.

Code	CM2017
------	--------





↓ Lutron Multimeters

LUTRON MULTI-METERS



www.lutron-electronic.com Lutron is an ISO-9001 approved company and was founded in 1976 and has grown to become the leading manufacturer of Test and Measuring Instruments of Taiwan. Various approved and pending patents in Taiwan, Germany, USA, China, etc. make Lutron a World-Classed manufacturer. Exportation to more than 65 countries, Lutron's reputation for stable, durable and reliable products is renowned world-wide. A professional instruments manufacturer with a comprehensive product range at a competitive price.

RS232 MULTIMETER

WITH PC SOFTWARE

Looks and operates like a normal multi-meter, but is actually a computer to technician interface!



The included CD-Rom (Windows) gives you the power of expensive data-logging equipment. Data is sampled (System Sample Rate 2s g 3600s) and stored in a popular database format for easy external application uses. Viewable on screen in digital, analogue and time graph formats. Excellent for intermittent faults, research, development, remote monitoring, or just as a general purpose meter. Includes attache' Case, software, D9 com lead, etc.

Code
DM9680



TRUE RMS 4½ DIGIT MULTIMETER

28 Range with a large display. Bench-top-meter performance. Housed in a tough yellow casing. 15mm LCD ±19999 display. 10MΩ Sample time 0.4~sec. DCV:0.2/2/20/200/1000 ±0.1% ACV:0.2/2/20/200/750 ±0.8% Current:0.2/2/20/200mA (Fused) +10A ±0.5-2% (True RMS AC Tested at 50Hz) Ω:200/2k/20k/2M/20MΩ ±0.5-0.8% Diode check (100µV res.) Continuity buzzer (<250Ω) Transistor NPN/PNP 0-1000 hFE Data hold Switch. Self test & zero.

Code
DM9027T



RUBBER PROTECTIVE HOLSTER SUIT DM9027T, 9680, 9080, 9090

Code
DMPH01

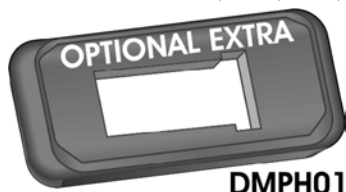

3.5 DIGIT MULTIMETER

This Multimeter offers everything for today's technician. Including 10MΩ in, hFE, up to 20 amp AC/DC current, Large 18mm LCD, beep continuity, frequency, capacitance, temperature, V protection & rugged construction. Safety lead system compatible. Yellow in colour. hFE test leads, Temp probe & Rubber holster are optional extras. DCV (+/- 0.8%) 200mV to 600V ACV (+/- 1.0%) 200mV to 600V DCI (+/- 1.0%) 200uA to 10A ACI (+/- 1.2%) 200uA to 10A Resistance 200Ω to 20MΩ Capacitance 2nF to 20uF Frequency 200Hz to 20KHz Temperature -20 to 750°C and 0 to 1400°F (Optional) HFE and DIODE TEST

Code
DM9090

TEMPERATURE PROBE

Code
TP01



3.5 DIGIT MULTIMETER

This accurate measuring instrument is modern in design & functions. Many features include 10M input, hFE, up to 20 amp AC/DC current, diode test, large 18mm LCD Display, over V protection and rugged compact construction makes this multimeter a valuable instrument. Safety lead system compatible. Yellow colour. Carry case, hFE test lead & rubber holster optional. RANGES; DCV (+/- 0.8%) 200mV to 1000V ACV (+/- 1.0%) 200mV to 750V DCI (+/- 1.0%) 200uA to 10A ACI (+/- 1.2%) 200uA to 10A Resistance 200 to 20M HFE and DIODE TEST

Code
DM9080



AUTO RANGE BAR GRAPH MULTIMETER

3200 DISPLAY COUNT 4 DIGIT

32 Segment Bar-Graph Fast change display housed in a tough yellow casing with safety test leads & auto power off. Sample time 0.5 sec for the digits AND Sample time 0.1 sec bar graph display. Ultra low power consumption (0.6mA) Range hold and Data hold buttons. Size 170x80x30mm DCV, ACV, DCA, ACA, Ω, hFE, Diode/Continuity ranges. Auto or Manual ranges: 320µA-320mA +10A 320mV-750VAC/1000VDC 320Ω-32MΩ

Code
DM9092





↓ Lutron Multimeters

GENERAL PURPOSE COMPACT METER

17 RANGES:

DCV: (1M Ω)2/20/200/600V \pm 0.8%
 ACV: (450k Ω)200/600V \pm 1.2%
 AC/DCI:2m/20m/200m/2A \pm 1.5%
 OHMS: 200/2k/20k/200k/2M/20M Ω \pm 1%
 Diode test Full NPN/PNP hFE
 measure 2.5mA power consumption
 Size: 120x72x37mm

DEPENDABLY RELIABLE

Although this meter is small and inexpensive, the features, accuracy & durability are that of a quality full sized meter. Includes DC and AC current with 2 Amp range (protected) 20M Ω , Diode and hFE. Ideal for use as a second meter for the tool box etc. With Test leads, etc. Fits in your pocket. 3½ Digit 12mm Display.

Code
DM9020



DIGITAL CAPACITANCE METER

LSI-circuit allows high reliability and durability. Accuracy is provided from a crystal time base and fast sampling. Overall a precision instrument in portable form. 3.5 digit. Optional carry case available. CA03. Rubber holster. DMPH01.

RANGES:

200pF 0.1pF \pm /-0.5%
 2nF 1pF \pm /-0.5%
 20nF 10pF \pm /-0.5%
 200nF 100pF \pm /-0.5%
 2uF 1000pF \pm /-0.5%
 20uF 0.01uF \pm /-0.5%
 200uF 0.1uF \pm /-0.5%
 2000uF 1uF \pm /-1.0%
 20,000uF 10uF \pm /-2.0%

Code
DM9023



DIGITAL LCR MULTIMETER

Intelligent microprocessor circuit, professional instrument. 19999 and 1999 counts dual LCD display + bargraph. Auto LCR smart check and measurement.

L : 200.00 uH to 2000.0 H
 C : 2000.0 pF to 2.000 mF
 R : 20.000 ohm to 200.0M ohm
 Series/Parallel modes are selectable.
 Five test frequency are available :
 100/120/1K/10K/100KHz
 Ls/Lp/Cs/Cp with D/Q/ESR Parameter.
 LCD Display with backlight.
 DC 9V battery or optional adapter in.
 RS232/USB computer interface.
 Optional SMD test clips and probe.

Code
LCR9183

SMD TESTER

Code
SMDA-22

SMD TEST CLIP

Code
SMDC21



WITH USB PC INTERFACE

↓ Other Multimeters

UNI-T DIGITAL MULTIMETER

INDUSTRIAL GRADE
 32 Range Auto-Off
 Highly accurate
 Typically \pm 0.5%

Voltage 1KVdc 750Vac
 Iac/dc 20A (1 μ A)
 Resistance 200M Ω
 (0.1 Ω) Capacitance
 20 μ F (2pF) Frequency
 20KHz (1Hz) HFE
 Diode Continuity

Over sized LCD 27mm
 Extra rugged case
 Rubber boot surround
 Black with yellow boot
 190 x 88 x 34mm
 Safety probes

Code
UT54



MASTECH DIGITAL MULTIMETER

COMPACT 28 RANGE
 Full featured meter with a double molded cover, safety leads, Hold Button, Stand, Auto-Power-Off. 1999 count LCD Vdc 1000V (100 μ V) Vac 750V (1mV) Ohms 20M Ω (0.1 Ω) Idc 10A (0.1 μ A) Iac 10A (1 μ A) HFE, Diode Continuity IEC61010-1 220g with 3xAAA 158x74x31mm Quality feel and control, Fantastic Price!

Code
MS8221A



MASTECH DIGITAL MULTIMETER

ECONOMICAL 19 RANGE
 As MS8221a without AC Current Ranges. Dark green protective double molded cover. Inbuilt back stand. Safety lead set, Handy Hold Button, Auto-Power-Off. 1999 count LCD Vdc 1000V (100 μ V) Vac 750V (1mV) Ohms 20M Ω (0.1 Ω) Idc 10A (0.1 μ A) HFE & Diode test 220g with 3xAAA 158x74x31mm Tough, functional, compact multimeter. Exceptional price. Excellent 2nd meter for the tool box.

Code
MS8230B





↓ Cable Testers

NETWORK CABLE TESTER

RJ45/CAT5 ETHERNET

Send-Receive tester Inject at one end and indicates at the other via LEDs.
 Tests 100/10base-T CAT5e. Plugs suit RJ-11 (6P6C) or RG-45 (8P8C).
 Includes carry case. Requires 9V battery.

Code
LANCTEST

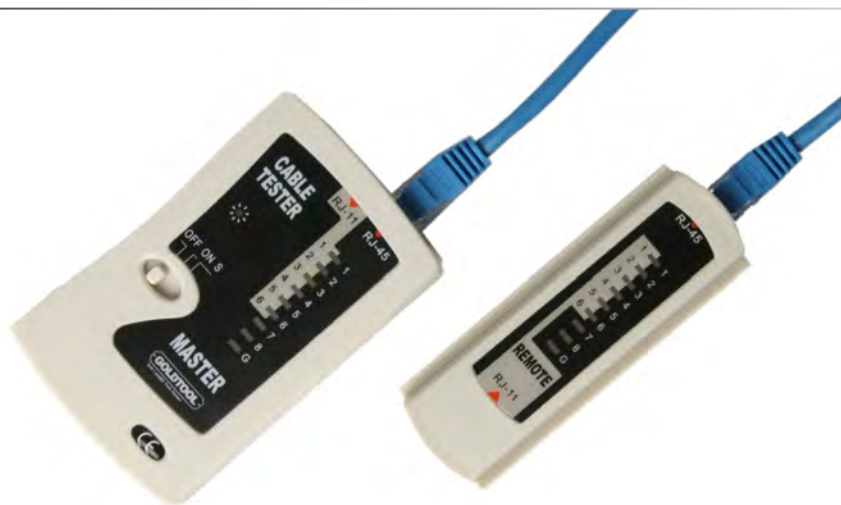

LAN & USB TESTER

RJ45 RJ11 USB COAX

Short/Open/Crossover, etc. BNC (Base10) & USB (A-B) RJ11 Modem/Phone cable RJ45 CAT5 Network UTP/STP each wire (8+) is tested individually & conclusively. Includes pouch. 145x85x25mm

Code
FT68BU

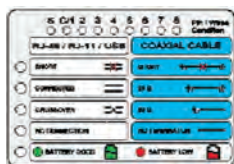

Requires 9V Battery

NETWORK CABLE TESTER

LCD CABLE TESTER WITH 8 LOCATION DONGLES

Network cable tester is a powerful tool to solve cable installation problems. The tester has a number of tests such as cable connection sequence, cable length reading, user-jumper identified and cable connection for continuity and determine any open circuit, short or cross-talk interference. Check wiring error in coax, CAT5e, CAT6e and telephone lines (adaptors req.). Includes 8 dongles, numbered and each with buzzer to identify cable tested for locating ease.

- Length measurement of twin twisted cable:
- Scope: 1350M.
- Calibration accuracy: 3% [+/- 0.5m]
- Locating cable identify function
- 8 pieces far-end passive test jacks [ID 1 to ID 8]
- Tester port: RJ45 meter port and RJ45 Loopback port
- 8 pieces far-end recogniser RJ45 port
- 2 pieces adaptors to BNC for coax Base10 testing
- Display: 4 x 16 character dot-matrix LCD reading
- Carry pouch for meter and adaptors, etc.
- Requires: 4x 1.5V AA batteries (not included)

Code
CT8108





↓ Accessories

RESISTANCE DECADE BOX

1 ohm step in slide switches.
1 ohm to 11,111,111 ohm.(10MΩ)
Professional, easy to use,
convenient desktop case. Suit
experimenters, testing and
repair. 4mm binding posts.
Simply add/subtract to value.
Size 147x117x51mm Yellow ABS.
Resistors are 1% 0.3 carbon.

Code
RBOX408



CAPACITANCE DECADE BOX

100pF to 11,111µF
100pF per step.
Professional, easy to use,
convenient desktop case.
Education, maintenance, and
repair. 4mm binding posts.
Simply add/subtract to value.
Size 147x117x51mm Yellow ABS.
Capacitors are 5% 50Vdc.

Code
CBOX406



INDUCTANCE DECADE BOX

10µH step
10µH to 111.1mH
Professional, easy to use,
convenient desktop case.
Production line, research,
laboratory. 4mm binding posts.
Simply add/subtract to value.
Size 147x117x51mm Yellow ABS.
Values are ±5% at 1KHz/1V/10mA.

Code
LBOX405



DIGITAL MULTIMETER CARRY CASE

SMALL SIZE

Size 135x65x25mm
Code CA04

STANDARD SIZE

Size 190x90x50mm
Code CA03



DIGITAL MULTIMETER PROTECTIVE HOLDER

Manufactured specifically for our Lutron Meter
range but will also suit similar.
Multimeter size Approximately
180x85x35mm with rounded edges.

DM9023
DM9027T
DM9073
DM9080
DM9090
DM9680

Code
DMPH01

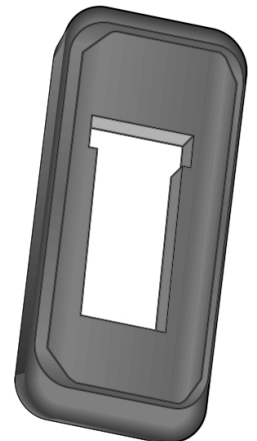

LARGE DURABLE WAVETEK CASE

PROFESSIONAL GRADE

Heavy-duty construction
Tough nylon material Tear
proof protection Double
lined and padded

Adjustable hand strap
Meter Leads compartment
Meter & Leads not included

Easily holds 100x40x200mm
Small medium or Large meter

Code
CA05A

Meter Not Included.





↓ Appliance

AC VOLTAGE DETECTOR

An Unique & Versatile Adjustable Non - Contact AC Voltage Detector. Which combines latest Digital Technology to detect AC Voltage from as low as 5 V AC. Sound and light feedback. Non-Contact AC Voltage Test from 5-1,000 V AC range (Adjustable Sensitive). Continuity check to identify 'Good Or Bad ' like Bulb, Fuse etc. Power full long lasting white LED light flashing torch. Battery- 1.5V x 4 pcs. (LR44, AG13, L1154 etc.) [included]

Code
MS47NS3



MULTI VOLTAGE TESTER

MULTI PURPOSE TESTER (5 IN 1)

Easy, Safe, Quick and Accurate.
AC voltage test: Contact test from 70 V AC to 250 V AC.
AC voltage test: Non-contact from 70 V AC to 600 V AC.
DC voltage test: 0-250 V DC.
Polarity test: 1.5 V DC to 36 V DC.
Continuity check: 0 - 80 M ohms.
Checks operating condition of ionizer.
Detects microwave leakage: ≥ 5 mw/cm² .
Safe Test - Water resistant.
1.5V x 2 pcs. (LR41, AG3, L736 etc.) batteries [included]

Code
MS18



NEON TEST SCREWDRIVER

INSULATED SHAFT BLADE

Steel Blade Tip 5mm
Mini Screw driver
145mm with a clear handle and inbuilt neon lamp that will indicate the presence of AC voltages 125-250Vac
Ideal for tag strips, etc. as it will indicate if the screw is live! Safety 1st.

Code
HT500



↓ Stud Finder

STUD-FINDER

BAR-GRAPH DISPLAY & BEEPER

Locates wooden studs, joists, electrical wires and metal pipes in plasterboard or plywood walls. 20mm deep

REQUIRES 9V BATTERY

Code
SF10285



STUD FINDER (5 IN 1)

MULTI-FUNCTION D.I.Y DETECTOR (5 IN 1)

Wooden Stud Detection up to 15mm thickness of gyprock. Buzzer sounds with red LED blinks slow, Fast or steady.
Detect Φ 20 mm metal pipe depth 30mm.
AC Voltage depth 50mm single sheath wire. Bonus Continuity check for fuse, bulbs, etc. and also a Built-in Polarity check (3V-24V DC).
Auto power off - Low battery warning - 1x AAA Battery [not included].

Code
MS-68-10



DIGITAL STUD FINDER (3 IN 1)

DISTANCE READOUT & BARGRAPH

Locate studs, find metal objects and detect AC voltage. Displays Large 2 digits numeric 99 counts for accurate reading of test result and 9 bar display indicate high sensitively sensing level. Detection of - Stud up to 38mm thick Gyprock with 2x4 inches stud, ACV minimum 30mm and Metal minimum 50 mm when pipe is Φ 20 mm. Measuring accuracy - ± 5 mm Audible multitone. 2x AAA Batteries required.

Code
MS-68-11





Other Multimeters

LOGIC PULSER

INJECTOR PROBE

Assists in logic circuit analysis and diagnostics. Outputs a square wave compatible with most logic families due to using the circuits own power source as reference. 2 speeds switched 0.5pps and 400pps Indicator LEDs.

Code
LP540H



LOGIC PROBE

WITH BURST MEMORY

Logic level detector with single-shot & short-pulse detection and hold. Multi Logic Standards compatible with most; TTL / CMOS / NMOS, etc. Over voltage protected. Indicates logic High, Low, intermediate and High-Z (Open Circuit)

Code
LP2800



Cable Testers

CABLE PAIR IDENTIFIER - TONE PROBE

ELECTRICIAN TELECOM DATACOM TECHNICIANS

The CZ1000 is a modern Cable Pair Identifier used for finding conductors in multi-pair cables, distribution boxes and tag strips. Includes an Oscillator (Transmitter) and Search Probe (Receiver). Connected to the cable to be traced, it provides a signal which the probe can detect. The probe will emit a warble tone when the tip of the probe is over or near the wanted pair. The transmitter is designed to easily fit into confined spaces of connecting pillars, whilst the receiver is ergonomically shaped to alleviate hand strain and easy use. Professional grade from AEGIS Australia. Includes Heavy-Duty protective Case. Requires 1x "9V" and 2x "AA" Batteries.

Code
CZ1000



PROBE WORKS THROUGH INSULATION

Other Multimeters

MEGA-OHM INSULATION TESTER

Made by Kyoritsu. Analogue insulation & continuity tester. Dust & splash proof knock resistant case. Three test ranges: 250V / 100M ohm 500V / 200M ohm 1000V / 400M ohm. Continuity test 3 ohm & 500 ohm. Audible live circuit indication. Overload protected. Meets all regulatory requirements. (CE, IEE, IEC, VDE, etc.) Compact, convenient, competent instrument. 106 x 160 x 72mm Includes leads.

Code
ICT3132

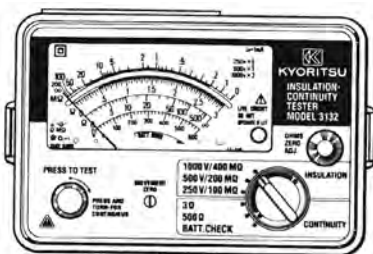

WIRE TRACER

WIRE TRACER / TONE GENERATOR (AUDIBLE & VISIBLE)

Includes transmitter & receiver unit. Ideal for Telephone Line test, Wire identification, Continuity check, Continuous audio sound and visible LED while checking continuity, Compact and pen size receiver. Comes with alligator clip and RJ11 plug, Radio type battery 9V (1Pc), AAA(2 Pcs) and carry pouch.

Code
MS-7847





↓ Accessories

OSCILLOSCOPE PROBES

Professionally manufactured for long reliable service. All probes sold individually with accessories included. 1:1 or 10:1 (1MΩ or 10MΩ) Cable length is 1.4M. 0V nul reference selectable on probe.

DC-60MHz

Code HP9060

DC-100MHz

Code HP9100

DC-250MHz

Code HP9250

REPLACEMENT TIP

Code PA102

ACCESSORIES KIT

Code HP9000



- Includes:
- TIP PA102 x 1
 - A CHANNEL ID CLIPS x 2
 - B SPRUNG HOOK
 - C GROUND LEAD
 - D INSULATING TIP
 - E IC ADAPTOR
 - F ADJUSTING TOOL
 - G BNC ADAPTOR*

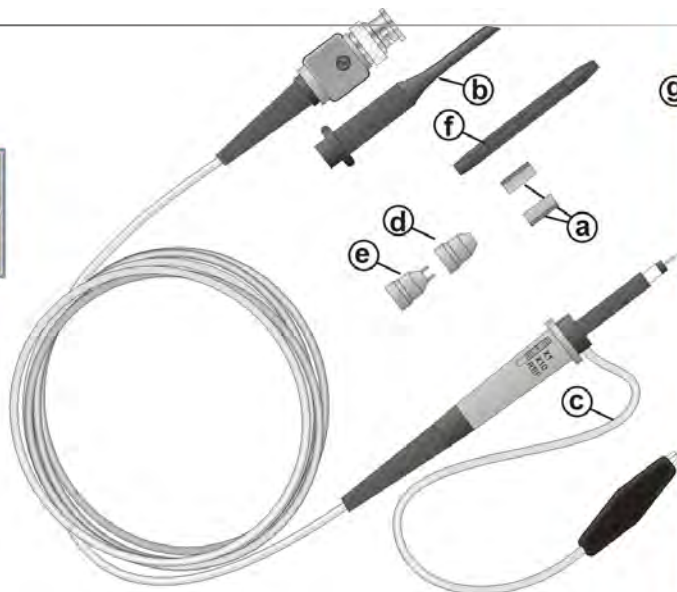

KITS SOLD COMPLETE

*with HP9250, HP9000 Only

BNC Adaptor

PA102



**60MHz
100MHz
250MHz**

STACKABLE 4mm SILICONE CONNECTION LEADS

A well proven connection with the advantage of being stackable. Very strong, highly flexible and soldering iron resistant, these jumper leads are virtually indestructible for total dependability on a reliable connection. There are three lengths available, 0.5, 1.0 and 1.5 metres in six colours for quick I.D. HCK Silicone test leads with Polyamide plugs, silver plated steel lam cage contacts. Highly flexible & impervious. Low Voltage 16A.

Colour	Length	Code
BLACK	0.5M	HCK05BK
RED	0.5M	HCK05R
BLUE	0.5M	HCK05BL
YELLOW	0.5M	HCK05Y
GREEN	0.5M	HCK05G
VIOLET	0.5M	HCK05V
BLACK	1.0M	HCK10BK
RED	1.0M	HCK10R
BLUE	1.0M	HCK10BL
YELLOW	1.0M	HCK10Y
GREEN	1.0M	HCK10G
VIOLET	1.0M	HCK10V
BLACK	1.5M	HCK15BK
RED	1.5M	HCK15R
BLUE	1.5M	HCK15BL
YELLOW	1.5M	HCK15Y
GREEN	1.5M	HCK15G
VIOLET	1.5M	HCK15V

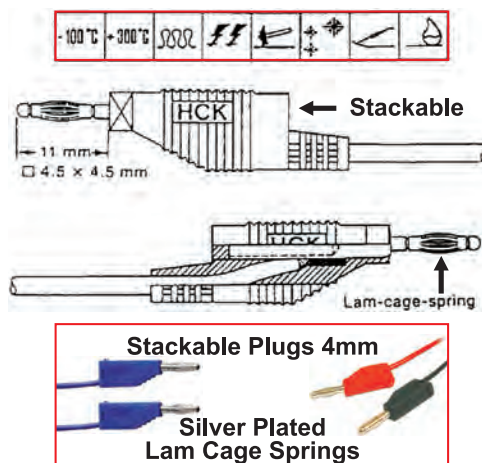

HEAT [300°C]
**Chemical
& Crush
Resistant**

SAFETY TEST LEADS

Compatible with all meters & any 4mm banana socket. The long reach plugs have a spring safety return that covers the plug on release, restricting the possibility of accidental shorting of contacts. Optimum quality, high voltage, ultra-flexible cable/connections/probes. Includes detachable screw-on alligator clips. Sold in pairs (Red+Black)

Code TL40

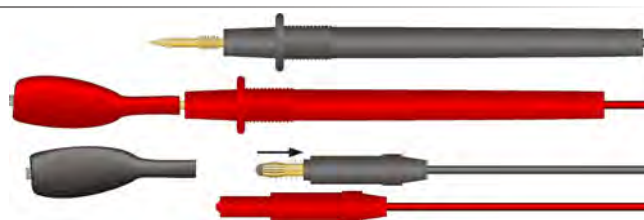

SAFETY TEST LEADS

Compatible with all meters & any 4mm banana socket. The long reach plugs have a spring safety return that covers the plug on release, restricting the possibility of accidental shorting of contacts. Optimum quality, high voltage, ultra-flexible cable/connections/probes. Terminated with heavy duty alligator claws (8mm wide). Sold in pairs (Red+Black)

Code TL50



RIGHT ANGLE TEST LEADS

Right angle 4mm banana plugs. High quality, high voltage, flexible cable, connections and probes. Includes detachable screw-on alligator clips. Sold in pairs (Red+Black) 1M leads.

Code TL45

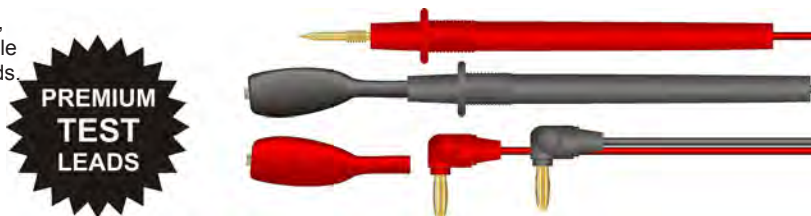

**PREMIUM
TEST
LEADS**



↓ **Accessories**

TEST LEAD SET

Description	Code
Pin plug	TL20



RIGHT ANGLE TEST LEAD SET

Description	Code
Banana plug	TL15
Pin plug	TL25



RIGHT ANGLE TEST LEAD SET

Description	Code
Banana plug	TL12
Pin plug	TL22



UNIVERSAL TEST LEAD SET - RIGHT ANGLE

Banana or pin plug to probe

Code
TL30



SAFETY TEST LEADS - STRAIGHT

Safety plugs highly insulated and long life. High quality, High Voltage, Flexible cable. Includes detachable screw-on alligator clips.

Length	Code
1 M	TL60



SAFETY TEST LEAD - RIGHT ANGLE

Safety plug highly insulated and long life. High quality, High Voltage, Flexible cable. Includes detachable screw-on alligator clips.

Length	Code
1 M	TL62



hFE TEST LEAD

Suit many meters.

Code
PL03



IC CLIPS

Very handy to have in the workshop. Requires wire soldering for attachment.

Colour	Code
Red	ICC2R
Black	ICC2B



BNC ADAPTOR

Use standard test probes with your CRO, etc.

Code
BP60

BNC Adaptors Section 07 PLUGS & SOCKETS



4mm PLUG-ON ALLIGATOR TEST CLIP

Sharp toothed, fully insulated rated at 2A. Will open 12mm wide. Steel spring.

Colour	Code
RED	HCK9209R
BLACK	HCK9209BK



ALLIGATOR CLIP PLUG-ON

4mm Socket

Collar	Code
RED	P714R
BLACK	P714B

2mm Suit Meter Probes

Colour	Code
Red	AC12R
Black	AC12B



JUMPER LEAD SET

Each 450mm long with alligator clips 10 assorted colours.

Code
JLK10



SMD TEST TWEEZERS

SINGLE HANDED
For testing components of fine SMD variety
Direct to PCB tweezers
90cm flexible lead to Safety Plugs

Code
TLSM15





↓ HCK Silicone Test Leads

HCK SILICONE TEST LEADS

In the workshop it is necessary to have total confidence in your test equipment. Safety is also a major priority. The HCK range of plugs and sockets have rigid plastic sleeves, thereby making physical contact and shorts between leads impossible. To use these leads it is necessary to own equipment or meters that use the 'Safety' system, otherwise an adaptor (HCK9122) is required. The HCK safety test accessories are built to be used with up to 1000 volts. Probe tips are nickel-plated solid brass with a free rotating barrel spring strong positive contact with minimum resistance. All plastics are Polypropylene or polyamide material for strong durability and insulation. Silicone synthetic rubber is used for lead construction. This boasts extremely good qualities, such as tear and notch resistant and high insulating properties. They can be bent, twisted or flexed thousands of times subjected to extreme temperature (such as soldering iron tips), vibration, chemicals, with negligible cosmetic effect and will still maintain high current capacity for a long life. Enormous lead flexibility, range of attachments, safety standard and durability of these test leads make them a must for the serious, and safe, technician. All safety leads & attachments are sold separately and available in black or red. Please, when ordering, indicate colour.

4mm SAFETY TEST LEAD

Pre-assembled, highly flexible lead in a one metre length. Terminated at both ends with an axial 4mm safety plug. The attachments below are to be used with these leads.

Colour	Code
Black	HCK9014BK
Red	HCK9014R



4mm SAFETY TEST LEAD

Pre-assembled, highly flexible lead in a one metre length. One end is right angle, the other axial 4mm safety plug. The attachments below are to be used with these leads.

Colour	Code
Black	HCK9016BK
Red	HCK9016R

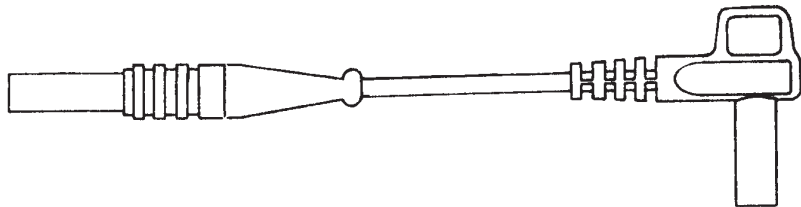

4mm SAFETY TEST PROBE

115mm in length. Highly insulated body with protection collar. The tip is equipped with a 4mm Plug for accessories.

Colour	Code
RED	HCK9112R
BLACK	HCK9112BK

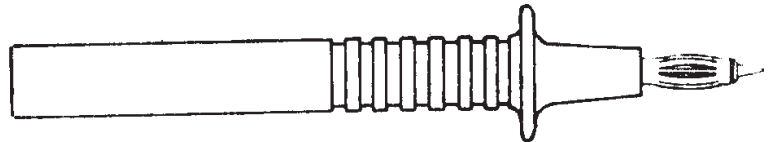

4mm SAFETY TEST PROBE

150mm in length with high collar for added safety when measuring High Voltages or hard to reach test points. Sharp tip for piercing insulation.

Colour	Code
RED	HCK9113R
BLACK	HCK9113BK

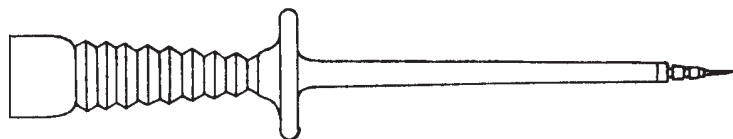

4mm SAFETY HOOK GRIP

A popular grip for IC connections. Wires & pins of up to 1.5mm thickness are held securely by the push to release spring pressure. Length 125mm.

Colour	Code
RED	HCK9116R
BLACK	HCK9116BK

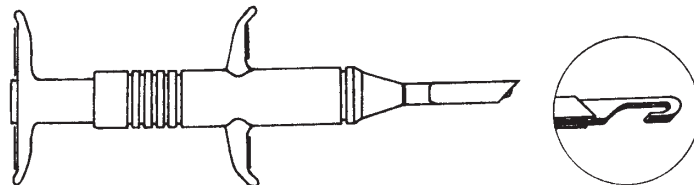

4mm SAFETY CLAMP GRIP

Two wire hooks open and spread to encircle the test point. 100mm long flexible tip for rigid contact of hard to reach contact points.

Colour	Code
RED	HCK9117R
BLACK	HCK9117BK

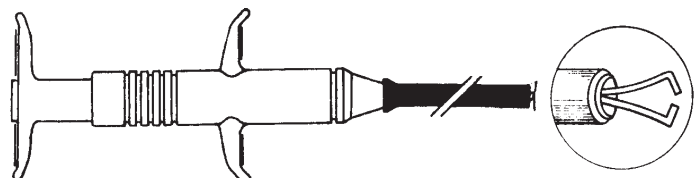



↓ HCK Silicone Test Leads

4mm SAFETY PROBE TEST LEAD

Ready assembled one piece probe with one metre silicone lead. Axial 4mm safety plug. The probe is 150mm long with a sharp steel tip and a 4mm plug for optional add-on accessories.



Colour Code

RED HCK9024R
BLACK HCK9024BK

4mm SAFETY PROBE TEST LEAD

Ready assembled one piece probe with one metre silicone lead. Right angle 4mm safety plug. The probe is 150mm long with a sharp steel tip and a 4mm plug for optional add-on accessories.

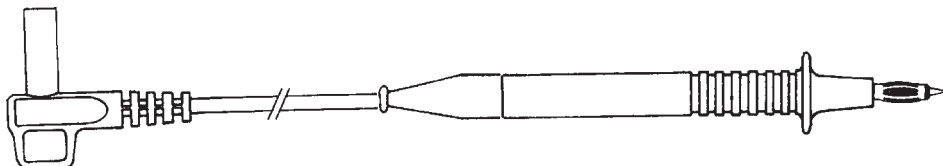

Colour Code

RED HCK9026R
BLACK HCK9026BK

4mm SAFETY JAW GRIP

Heavy duty jaws open up to 20mm for a high current, strong rigid connection of motor terminals, fuse connections etc. Max 20A 130mm in length

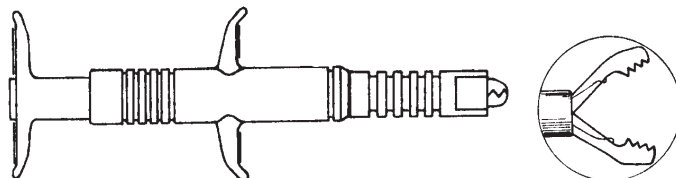

Colour Code

RED HCK9119R
BLACK HCK9119BK

4mm SAFETY ALLIGATOR CLIP

For a sure strong connection of up to 20mm diameter. Will carry currents of up to 34A. 80mm in length. High tension metal spring.

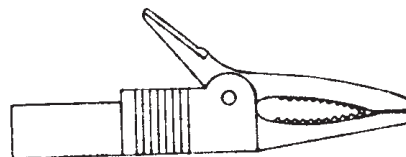

Colour Code

RED HCK9755R
BLACK HCK9755BK

4mm PLUG-ON ALLIGATOR TEST CLIP

Sharp toothed, fully insulated rated at 2A. Will open 12mm wide. Steel spring.

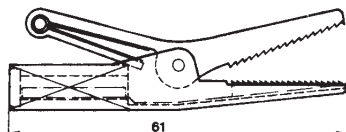

Colour Code

RED HCK9209R
BLACK HCK9209BK

4mm PLUG-ON TEST PROBE

Designed for attachment on standard 4mm system. 130mm in length with sharp steel tip for piercing insulation and oxide layers

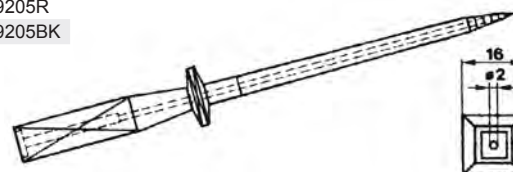

Colour Code

RED HCK9205R
BLACK HCK9205BK

CHANGE OVER ADAPTOR

To make connection of safety plugs to standard 4mm system.

Colour Code

RED HCK9122R
BLACK HCK9122BK



COUPLING CONNECTION

Female to female adaptor for safety lead extension etc. Will also accept standard 4mm.

Colour Code

RED HCK9123R
BLACK HCK9123BK



ADAPTOR 2mm TO 4mm

Standard 2mm system to the above 4mm.

Colour Code

RED HCK9226R
BLACK HCK9226BK



ADAPTOR 4mm TO 2mm

Standard 4mm system to the rare 2mm.

Colour Code

RED HCK9227R
BLACK HCK9227BK





↓ Books

SEMICONDUCTOR COMPARISON TABLES V1

Complete Alpha-Numeric listing of semiconductor components including Diodes, Transistors, ICs, Triacs, plus much more. Consists of a short electronic description, diagram reference and where possible, substitutions. Very handy data books. Paired with Volume 2 below [MAN37].

VOLUME ONE A→Z

eg. AD, BC, BCW, BCY, CCS, LA, MC, MM,....

Code
MAN36



Purchase Both
MAN36 MAN37
And Receive A
10% DISCOUNT

MASTER ACOUSTIC REFERENCE

MASTER HANDBOOK

For the more technically advanced who may want the ultimate in the reference for acoustic science. Easy reading explanations for Room acoustics, recording, studio, many topics in sound engineering. Large volume of over 600 pages. F. Alton Everest 4th edition

Code
MAN604

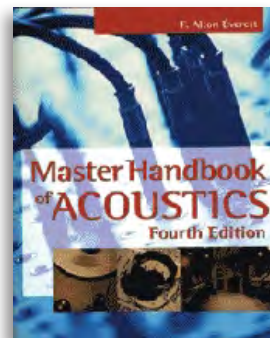

SEMICONDUCTOR COMPARISON TABLES V2

Complete Alpha-Numeric listing of semiconductor components including Diodes, Transistors, ICs, Triacs, plus much more. Consists of a short electronic description, diagram reference and where possible, substitutions. Very handy data book. Paired with the MAN36 Volume 1 above.

VOLUME 2 1N→U

eg. 1N, 1S, 2N, 2SA, 2SB, 2SK, 3SK, UPC,...

Code
MAN37



Purchase Both
MAN36 MAN37
And Receive A
10% DISCOUNT

CAR AUDIO SPEAKER PROJECTS

20 COMPLETE PROJECTS

Get stuck straight into building! Talk about simple! This illustrated step-by-step guide makes leading edge car audio speaker systems easy. This book helps you plan, design & build the ultimate car audio. 244 pages. Dan Ferguson

Code
MAN610

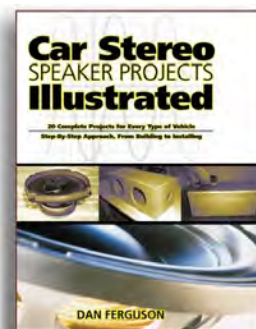

MICROWAVE MANUAL

There are many dangers involved in servicing microwave ovens. You should prepare yourself with information on the correct safety precautions and basic operations. This 66 page book offers all this information and much more including oven testing, door leakage, cooking sensors, common faults, diagnostic flow charts, popular circuits, and lots of general knowledge for microwave servicing.

Code
MAN-MICRO

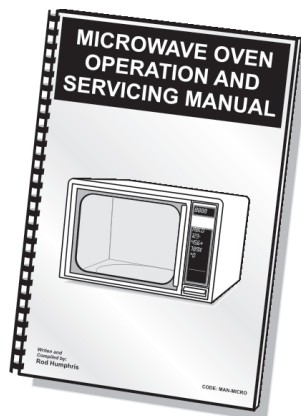

SPEAKER DIY REFERENCE

DESIGNING BUILDING & TESTING YOUR OWN SPEAKER SYSTEM

A complete reference to building your own speakers. It covers all the latest types and models of speakers and is aimed at hobbyists, do-it-yourself audiophiles and electronic repair technicians. With formulas and samples. Highly acclaimed resource. 223 pages. David B. Weems

Code
MAN600

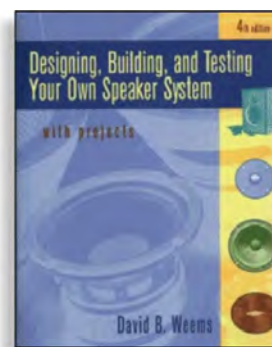

TV DEFLECTION CIRCUITS

Theory of operation & the repair of New technologies DTV, SVM, etc., 100Hz CRT, Monitors, projectors, etc. This publication will help you fix the difficult faults, or at least guide you towards the correct diagnosis of most problems experienced in the deflection circuitry. An Expert in a book! This book will prove informative and educative. Saves you time & money. 150 pages with illustrations

Code
MANDEF

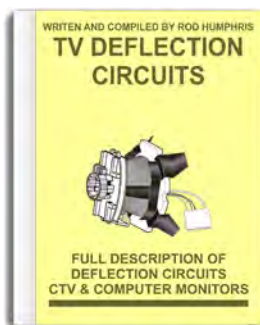

TV & VCR FAULT CURES - IKON IMAGES

BOTH MANUALS ON CD-ROM

The whole extensive library! Fault Cures by IKON IMAGES. Includes both manuals in MS-Word format for easy searching, etc. Plus vast amounts of additional information like service manuals, chassis ID pictures, monitor repairs, & more!

Code
IKONCDR



IKON IMAGES
CD & Manuals
Give you the correct advice
Instruction on how to fix a
particular VCR-TV problem.
Indexed to Model & Fault.

OVER 1500 CURES !



↓ Test Discs and Tapes

TRACK & FOCUS OFFSET/GAIN ADJUST

GERMAN DDD DAMAGED

78 min, 45 tracks, of 1KHz 0dB
With intentional physical errors
to test and align error tracking
& laser gain.

Error Area in Information Layer
0.2mm to 3mm in 0.1mm
steps as read to track number.
Save time and effort in CD
assessment and adjustment.
Instruction booklet.



Code
LASERCD



TECHNICS TEST DISK

This test disc with measured "scratches"
Assess a player's ability to track poor
quality compact discs. No guessing.

Track 1 1KHz reference

Track 2 L+R 0 dB

3-8 Interruption in information layer
From 0.4mm to 0.9mm

9-15 Black Dot at read out side tests
From 0.3mm to 0.9mm



Original Part No Code
SZZP1054C CDT016



AUSTRALIAN MADE TEST CASSETTE

Excellent test tape to assist
Hi-Fi enthusiast the tradesman.
It offers a range of tests to
determine faults & alignments.
These tests can be performed
without technical knowledge or
costly test equipment.

1-6 1KHz sine wave
6-12 5KHz sine wave
12-18 2K5Hz sine wave
18-24 Beep every 10s

Code
AAC9



www.wescomponents.com

ONLINE DATA-BASE

Up to date & searchable Database is online free

Start here:

www.wescomponents.com/datasheets/

www.wescomponents.com/ic/

www.wescomponents.com/search/

<input type="text"/>	Search This Site
<input type="text"/>	Search Restricted Zone
<input type="text"/>	Search Semiconductors

↓ CD DVD

RADIAL CD & DVD CLEANING KIT

INSERT DISK AND CLEAN

Non-scratch chamois Simply
insert CD Rotate w/ handle
Cleans disk No scratches

Code
HL607



CD & DVD DISC SURFACE REPAIRER

DISK CLEAN MACHINE

Insert scratched disc, Apply the
special fluid Close and turn the
handle! Repairs general light
duty scratches that may hinder
correct playing of both DVDs,
CDs and software too. Two
types of cylinder rollers one for
surface repair and another for
general cleaning.

Code
PC7091

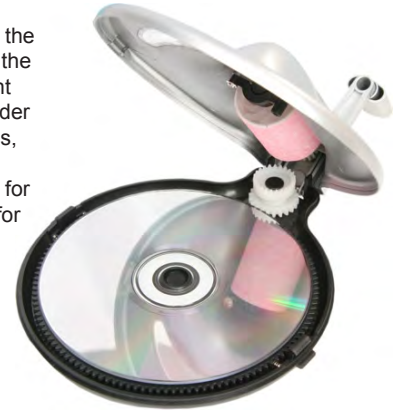

CD & DVD LENS CLEANER

Will clean a CD laser
lens without having to
dismantle the player.
This unique disc has
narration and music.
Simply insert the disc,
press play and a voice
will guide you through
the process! Although
primarily a CD, this
will clean DVD players
(single laser).

Code
HN3103



DVD-LENSCLENE

GAMES & DVD PLAYERS

Cleans optical laser lens, restoring
premium audio and visual quality, etc.
Also includes tests: Sound effect test
Surround sound test Picture colour test
Sound & Colour test Premium product
from AF International (UK)

Code
DVD000





→ Service Aids

↓ Tape Dispenser

DESK TAPE DISPENSER

LARGE & WEIGHTED

Accepts 1" & 3" Tapes (25mm or 75mm)
80x90x205mm No-scratch Felt under
Requires tape

Code
DTD8977



↓ Tape Packaging

STICKY TAPE

COMMON CLEAR STICKY

Individually seal packed for maximum
freshness. Clear. Will not tear
Width x 66 Metres long.

Size	Code
12mm	ST4724
18mm	ST4725



↓ Tape Dispenser

PACKING TAPE DISPENSER

BOX SEALING PISTOL 3"

Light weight pistol grip Roll-On 2" wide
Suit 3"Ø tapes. Adjustable brake for tight
consistent seal. Max tape roll OD is 5"Ø

Code
H11CP



↓ Tape Packaging

PACKAGING TAPE

2" WIDE BOX TAPE

48mm x 75 Metres professional grade
Box sealing tape. Will not tear.

Colour	Code
Brown	PT1035
Clear	PT1090



↓ Tape Gaffer

GAFFER CLOTH TAPE

NASHUA 357 48mm x 40 Metres

Classic. Best available. Cloth reinforced vinyl.
Durable & Added strength. Torn to length
without tools. Aggressive adhesive waterproof

Colour	Code
Black	GAF357BK
Silver	GAF357SL
White	GAF357WH



GAFFER CLOTH TAPE

BLACK 399 48mm x 25 Metres

Industrial grade cloth coated. Very aggressive
hi-tack stick Rubber adhesive. Waterproof Cotton
reinforced. Tear by hand 3" Reel. 25 Metres long.

Code
GAF399



GAFFER TAPE WARNING!

BLACK & YELLOW CLOTH

48mm x 25 Metres roll Cloth imbedded nylon tape.
Alarmingly coloured !
Kick / walk areas, etc. Tape down cables, etc.

Code
HCT3220



↓ Tape Masking

MASKING TAPE

PAPER BACKED 50M

Easy-to-tear backing. No residue
adhesive. As used in painting Mask-Off
areas, etc. Beige 50 Metre rolls.

Size	Code
24mm	MSK2002
48mm	MSK2004



↓ Tape Insulation

INSULATION TAPE

FIRE RETARDANT 0.19x19mm x 20M

High Quality 0.19mm PVC Tape

Colour	Code
Red	FRT20RD
Green	FRT20GN
Blue	FRT20BU
White	FRT20WH
Yellow	FRT20YL
Black	FRT20BK
Yellow & Green	IT20YG



↓ Tape Duct

DUCT TAPE

PVC 2" IN 30M ROLLS

Clear-Adhesive backed Strong durable PVC
tape. Poly Vinyl Chloride (PVC) Malleable &
Weather proof. Popular builders tape.

Colour	Length	Code
Silver	30M	DT4420
Black	30M	DT4410



↓ Tape Heat Shrink

HEAT-SHRINK TAPE

SHRINKS TO SEAL

Thin Irradiated Polyolefin tape. Shrinks and
amalgamates forming a rigid seal on even
complex items. Make Y shapes. Simply
wrap & heat to shrink. Black. 20mm x 50M.

Code
HST20



↓ Tape Self Amalgamating

SELF-AMALGAMATING STRIPS

RUBBER BUTYL 12mm

Highly adhesive synthetic Rubber &
resin based strips. Cures to a single
mass. Seal Long-term weather
proofing. 1/2" Strips in short lengths

Size	Code
12.5x255mm	CXS101



SELF-AMALGAMATING TAPE

RUBBER BUTYL 20mm

Highly adhesive synthetic Rubber
& resin based tape. Cures to a
single mass. Seals & water-proofs
0.8mm x 19mm x 10 Metres.

Code
SFRT10



SELF-AMALGAMATING TAPE

RUBBER BUTYL 40mm

Highly adhesive synthetic Rubber
& resin based tape. Cures to a
single mass. Seals & water-proofs.
Black. 40mm x 5 Metres.

Code
SAT140





→ Service Aids

↓ Tape Foam

FOAM TAPE SINGLE SIDED 25M

3mm POLYETHYLENE 7100

Soft density open cell foam. Aggressive acrylic adhesive. Sponge type for draft seal. Large quantity reels. Bulk.

Width x Length	Code
9mm x 25M	APT6351
12mm x 25M	APT6352
18mm x 25M	APT6353



FOAM TAPE SINGLE SIDED 2M

3mm POLYETHYLENE 7100

Soft density open cell foam. Aggressive acrylic adhesive. Sponge type for draft seal, Dust barrier, Gaskets, etc.

Width x Length	Code
9mm x 2M	APT3092
12mm x 2M	APT3122
18mm x 2M	APT3182



FOAM TAPE SINGLE SIDED - 1 METRE

3mm POLYETHYLENE 7100

Soft density open cell foam. Aggressive acrylic adhesive. Sponge type for draft seal, Dust barrier, Gaskets, etc. As supplied w/ speaker kits.

Width x Length	Code
9mm x 1M	GT7100



FOAM TAPE SINGLE SIDED THIN

2mm POLYETHYLENE 7100

Soft density open cell foam. Aggressive acrylic adhesive. Sponge type for draft seal. Dust barrier, Gaskets, etc.

Width x Length	Code
18mm x 2M	APT2182



↓ Knives

RETRACTABLE KNIFE

PLASTIC BODY 140mm

Lockable pocket size
With Snap Off Blades

Code
HT310

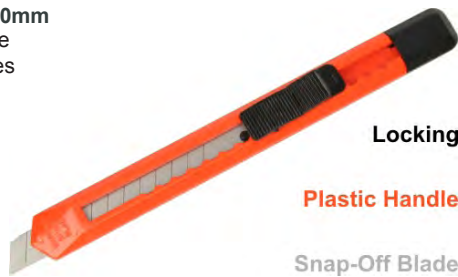

Locking

Plastic Handle

Snap-Off Blade

RETRACTABLE KNIFE BOX CUTTER

FULL SIZED UTILITY KNIFE

Zinc alloy Metal body. 140mm

Code
HT8003



10 PACK OF BLADES

Code
HT8066



→ Service Aids

↓ Tape Double Sided

DOUBLE-SIDED TISSUE

TISSUE ACRYLIC TAPE

Very thin tissue paper Premium grade Stylus 740. Aggressive hi-tack acrylic PH neutral for photos, etc. Double sided 33 Metres.

Size	Code
12mm	DST5238
24mm	DST5242



DOUBLE-SIDED CLOTH

GAFFER HEAVY-DUTY DUAL

Premium grade Stylus 720. Hand tear cloth. Aggressive natural rubber solvent adhesive both sides. 25M. Suit carpet, substrates, etc

Size	Code
24mm	DST4506
48mm	DST4510



DOUBLE-SIDED FOAM

POLYETHYLENE 5589 BLACK

High density closed cell foam for outdoor mounting. Suit light weight fixing plastic, etc. Permanent bond Both sides. 0.8mm Black. 5/10M

Width x Length	Code
18mm x 5M	IT50
12mm x 10M	DST4884



DOUBLE-SIDED FOAM

POLYETHYLENE 2010 WHITE

Double sided EVA foam tape. Aggressive acrylic adhesive. Light to medium weight fixing. Permanent bond internal mount 1.0mm thick white large reels

Width x Length	Code
12mm x 50M	DST4945
18mm x 50M	DST4946



↓ Miscellaneous

SOUND DEADENING MATERIAL

SEE SECTION 18 CAR AUDIO ACCESSORIES

As used to sound proof vehicles for car audio. 2x 300mm² Sheets

Code
MAT302

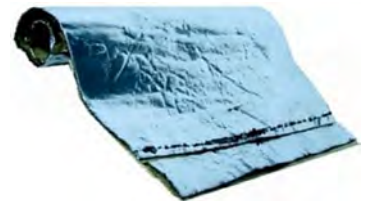

SECURITY LABELS

Tamper-proof seal sticker.

Place over screw holes and unit seals to stop tampering. Suit repairs with warranty, etc. Roll of 500 stickers.

Code
WL500

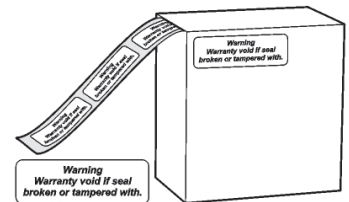

GLUE GUN 60W

Bonus plastic case includes glue sticks
Trigger action gun 11mm glue sticks (x6)

Code
NGG60D

HEAT GLUE STICKS

Order One to Receive ten
11mm x 100mm Pack of 10

Code
NGGS10





↓ PCB

CONDUCTIVE PEN

Draws fine lines of conductive silver for design & repair of surface mount, standard & membrane type circuits. Self cleaning tip for smooth, highly conductive silver traces.

Code
CW2200STP

Micro Fine Tip

Code
CW2200MTP



OVER COAT PEN

Protective conformal overcoat paint in an easy applicator pen. 5g (0.16oz) Applies a tough coat for insulating and protecting against corrosion, shorting and high voltage arcing.

Colour	Code
Green	CW3300G
Clear	CW3300C



CONDUCTIVE SILVER GREASE

CHEMTRONICS CIRCUIT WORKS Pure silver & advanced silicone lubricants for premium electrical and thermal conductivity. Chemically inert, fully tested & suitable for metal rubber & plastic. Ideal for switch contacts, etc.

Code
CW7100

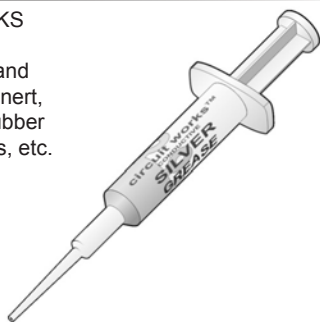

SILVER CONDUCTIVE PAINT

Dries to leave a conductive path. Suit PCB repair & connections to non-solderable materials, repairs rear demisters, etc. Excellent adhesion & conduction properties. Simply paint on. 3g Phial.

Code
SCP03B



RUBBER KEYPAD REPAIR KIT

Repair rubber push-button key pads on remote controls. Restores conductivity to worn carbon key contacts. Two part formula solution. Repairs good for 500,000 keystrokes. Mix & repair. Carbon/silver solution. Chemtronics CircuitWorks

50 Applications

Code
CW2605



↓ Heat Transfer

HEAT TRANSFER COMPOUND

SILICONE BASE TUBES

Size	Code
10g	SIL10
150g	SIL150

SILICONE BASE SYRINGE

Size	Code
25ml / 50g	SIL50

NON-SILICONE SYRINGES

Size	Code
10ml	RF44
35ml / 70g	HTC35SL



SILICONE HEATSINK COMPOUND

THERMAL ADHESIVE

"OEM" Specified Made in Japan. Sets hard. Improves thermal conductivity to the max! 150g.

Code
TSE3843W



↓ Silastic and Sealant

DOW CORNING SILASTIC

Original silicone elastomer for high voltage insulating. Non corrosive. Clear. Cures tough, rubbery solid.

Size	Code
90ml Tube	SIL738



DOW CORNING HEAT RESISTANT SEALANT

SILICONE RUBBER RED Colour 260°C Rated version of 738

Size	Code
90ml Tube	SIL736-90
300ml Cartridge	SIL736



→ Oils

OIL PEN

'Sewing Machine Oil' Highest Quality in a convenient application pen. Press to release.

Size	Code
5ml	EML05P



↓ Glues

ADJUSTMENT LOCKING SEAL

Don't use my good Nail polish dear! Purpose made for locking adjustments, screws, etc. Tamper Evident Seal 15ml.

Colour	Code
Red	EBLR15
Green	EBLV15





↓ Glues

LOCTITE ULTRA FAST

The Best Instant Adhesive
Cyanoacrylic Ester. For bonding metals
most plastics, etc. Large 25ml bottle.
Ultra-fast drying

Code
LOC401



LOCTITE 454 GEL

Surface insensitive for
porous materials inc'
wood, ceramics, felt, cork,
etc. More suited than
LOC401 for gluing pulleys
onto capstan motors, etc.

Code
LOC454



INSTANT ADHESIVE GLUE

Cyanoacrylate
2 gram tube.
Bonds instantly.

Code
ISG2



PLASTICS GLUE

WITH PRIMER PEN
Bonds ALL Plastics, including
Polyethylene (PE) and Polypropylene (PP)
Easy to Apply, Dries clear for clean, neat
results, Fast Bond: 2-30 seconds.
Also bonds plastic to other surfaces:
Metal, timber, china, rubber, leather.

Code
SEL02



TARZANS GRIP

SELLEYS GENERAL PURPOSE GLUE
Dries clear. Ideal for ceramics,
wood, metal, leather, vinyl,
canvas and many plastics etc.

Code
SEL01



CONSTRUCTION ADHESIVE

PRO-SPEC STRONG-FIX
Solvent based construction adhesive
with a non-runny consistency. It is brown
in colour as applied and is suitable
for bonding wood panelling, plywood,
plasterboard, fibre cement, wooden
flooring applications, ceramic tiles as
well as general wood repair.

Code
SEL04



↓ Grease Lubricants

POLYGLIDE COLOURLESS

GERMAN KONIG 5147 EQUIVALENT
Premium Grade Grease for plastics.
Does not harden even after long
immobility. Free of silicone oils.
Electrically neutral. Colourless
lubricator. Also suits nylon, etc.
Made in Germany for excellent long-life

Size Code
35g GR5147



WHITE GREASE PASTE

MOLYKOTE-DX 50g Tube
Dow Corning German Lubricant
Heavy load Surfaces & bearings
Lithium solid grease paste
Weather resistant. 50g Tube.
Anti-corrosive -35°g+125°C.

Size Code
50g MK6195



SUPER-LUBE IN A TUBE

Synthetic grease with Syncolon (Teflon)
PTFE has high temperature tolerance
230°C. Highly lubricious, clear and
non-toxic. Excellent dielectric properties.
Impervious to salt water. USA made.

Size Code
85g SL21030

More Super-Lube Options - Next page...



GREY GREASE GRAUES FETT

MoS2 LANGZIET FETT
www.Ligui-Moly.com
LM 47 Long Life High Quality
Suits metal bearings, etc.
Premium German made
GMBH -30°g +125°C
DIN51502KPF

Size Code
100g GR3510



SILICONE GREASE COMPOUND

Highest quality electrical insulator,
moisture repeller. Eliminate HV
tracking. Lubricate joints, etc.
Non-toxic MIL-1-8660B.
eg. Car ignition switches,
HV pix tube connections, etc.

Size Code
35ml SCO35SL



SPECIAL PLASTICS COMPATIBLE GREASE

Synthetic mechanical lubricant for
thermoplastics, Polycarbonates, ABS, etc.
Also known as Montage grease. Ideal for
switch contacts and Plastic g Plastic,
Plastic g Metal friction points. eg.
Photocopiers, timers, etc...
Light-brown colour. Non-melting.

Size Code
35ml SPG35SL



CONTACT TREATMENT GREASE

An extra high quality non-melting grease
for the most critical applications where
long term performance and reliability
are essential. High tenacity for vertical
surfaces, sliding contacts. Anti-static,
safe on most plastics, paint and rubber.

Size Code
35ml/35g SGB35SL





↓ Wipes Cleaners

KIM-WIPES®

NO-TEAR TISSUE BOX

Delicate Task Wiper is a light duty wiper that can handle a variety of delicate tasks. Easily wipes up liquid and dust. Anti-stat dispensing reduces lint and electrostatic discharge, controls usage and portability reduces waste. 280 wipes, 110x210mm

Code
KIMW4120



ADVANCED CLEANING CLOTH

LENS QUALITY WIPE

Special material cloth for cleaning opticals like camera and laser lenses, even glasses. No lint. No residue. Like silk. 6" Square



MADE IN JAPAN

Size Code
150x150mm CLN1515

FINE DENIER YARN POLY CLOTH

TOUGH & DURABLE CLEANING WIPE

Made from recycled PET bottles 66% & Very fine knitted polyester 34% Non-scratching dust-free cloth Ultra-pure clean-room product Made in Japan. 220x220x0.8mm



Code
ECQ2310

↓ Isopropyl

LIQUID HEAD CLEANING SOLUTION

Isopropyl Alcohol.
VCR/Audio solvent

BOTTLE 20ml SQUEEGEE 20ml
Code CS500 Code CS505



RECORD CLEANING KITS

IDEAL FOR THE ENTHUSIAST
Kits include carbon fibre brush, stylus cleaner, vinyl cleaning fluid and cloth packaged in a case for easy storage. Kit 2 has the addition of a CD cleaning fluid and cloth.



Description Code
LP Cleaning Kit MHFC-9
LP & CD Kit MHFC-2

Section 5 for details....
*Fluid is flammable goods so must transport by road



RECORD WASH - ANTISTATIC

Fluid Plus Cloth for Vinyl Records

Risk free wash for removing grit & grime from grooves and reduce static build up. Non abrasive for gentle and effective vinyl cleaning. Standard bottle or squeegee bottle. Includes lint-free cloth.

Description Code
250ml Bottle & Cloth RC-1
200ml Squeegee RC-2
Replacement Cloth DC-103



STYLUS NEEDLE CLEANER

BRUSH N' LIQUID

Cleaning solution with bottle brush in lid. Professional grade. Remove grit & grime from stylus needle. Flammable liquid.

Size Code
20ml SC-1



OFFICE WET WIPES

Kimberly-Clark Product
70x Pre-Moistened Multi-Surface Non-Scratch disposable cloths in a handy dispenser bottle. Commercial grade disinfectant. For cleaning office equipment, etc. Australian made by Kimberly-Clark. Premium grade wet wipes.

Code
KIM4100



SCREEN-CLENE WET WIPES

LCD & PLASMA SCREEN CLEANER

100 Sachets of non-smearing anti-static wet wipes for cleaning monitor screens. Box full of individual packs. Always find them ready moist. premium quality product.

Size Code
125x190mm ea. SCS100



SCREEN-CLENE IN A CAN

LCD & PLASMA SCREEN CLEANER

Pump action cleaner spray for clear glass & plastic surfaces like TV Screens, Photo copiers, Gameboy, Laptop, monitor screens. Anti-static. No alcohol. Non flammable.

Size Code
250ml SCS250



SCREEN-CLENE SAFECLOTHS

LINT-FREE CLEANING

Non-woven super absorbent anti-static cleaning cloths 50 pieces in a resealable bag 330x330mm soft perforated Suit general cleaning uses.

Code
SCH050



PLASMA/LCD/CRT SCREEN CLEAN

Non-Scratch Micro fibre cloth for flat screens. Will remove dust, dirt, greasy finger prints, etc. easily and quickly. Includes a Specially developed IPA / alcohol free safe water based cleaning fluid with spray pump bottle. Ensures cleaning compatibility on all types of screens.

Code
AM85146



30ml FLUID ONLY
2x Squeegee bottles

Size Code
30ml AM85149



REPLACEMENT SPONGE

Code
AM85150





SCREEN CLEANING KIT FOAM

WITH BRUSH & CLOTH

200ml Squeegee bottle.
Water based cleaning.
Foaming formula for
Screens, lens, disk.
No-drips or smears.
Micro-fibre cloth 20cm².
Retractable dust brush.

Code
HN4128



SCREEN CLEANING KIT GEL

WITH BRUSH & CLOTH

100ml Squeegee bottle. Specially
formulated water based cleaning.
Non-drip gel mist for
Screens, lens, disk. Micro-fibre cloth 20cm².
Retractable dust brush.

Code
HN4133



SCREEN CLEANING KIT

WITH BRUSH & CLOTH

200ml Squeegee bottle
Specially formulated
water based cleaning
Clear liquid mist for
Screens, lens, disk.
Micro-fibre cloth 20cm².
Retractable dust brush.

Code
HN4131



SCREEN CLEANING KIT

WITH BRUSH & CLOTH

100ml Squeegee bottle
Specially formulated
water based cleaning
liquid mist spray for
Screens, lens, disk.
Super-fine micro fibre
cleaning cloth 10cm²

Code
HN4129



SCREEN CLEANING KIT

FIRM BRUSH CLOTH

Novelty shaped car
desktop solution for
cleaning flat surfaces like
LCD screens, etc. Bonus
dusting brush. 12ml
squeegee bottle water
based cleaning

Code
HN4115



SCREEN CLEANING KIT

FIRM BRUSH CLOTH

Micro-Fibre foam back
Novelty shaped bug desktop
solution for cleaning flat
surfaces like LCD screens,
etc. 12ml squeegee bottle
water based cleaning.

Code
HN4117



DUSTGO MICROFIBRE CLOTHS

FOR SENSITIVE SURFACES Bill Microfibre Technology Co.
Switzerland SGS Authorised Quality Assured System. The formula of
each cloth is adapted to suit the application precisely for maximum
effect & assured long-term safety. Made from a proportion between
PET Segment and PA Matrix. High performance product for long
life, re-use, dust cloths. Use wet or dry. Will not scratch. Machine
washable. Each cloth is 160x180mm. One cloth supplied per pack.



DIGITAL CAMCORDER LENS

LIME MICROFIBRE

65% PET 35% PA Matrix

Code
BMT-D5062



PLASMA & LCD SCREENS

GOLD MICROFIBRE

65% PET 35% PA Matrix

Code
BMT-D5017



NOTEBOOK SCREENS

BLUE MICROFIBRE

70% PET 30% PA Matrix

Code
BMT-D5208



LCD MONITORS

SILVER MICROFIBRE

70% PET 30% PA Matrix

Code
BMT-D5024



OFFICE EQUIPMENT

WHITE MICROFIBRE

80% PET 20% PA Matrix

Code
BMT-D5109





14 TOOLS & TEST EQUIPMENT

14 TOOLS & TEST EQUIPMENT

→ Service Aids

↓ Brushes

BRUSH ESD DUSTER 10mm

HORSE HAIR BRUSH

Zinc plated steel handle.
1cm Tuft oval brush for general ESD safe dusting
Quality instrument.
Low loss of fibres.
Long life Horse hairs.
120mm length handle.

Code
HT2033



BRUSH ESD SCRUBBER 10mm

HOG BRISTLE DOUBLE ENDED

Zinc plated steel handle.
1cm Tuft oval brush for general ESD safe scrubbing
2nd Chiselled brush end for tight corners, etc.
Long life Hog bristles.
120mm length handle.

Code
HT2032



BRUSH ESD SCRUBBER SMALL

ESD BRISTLE 4" SCRUBBER

Static neutral plywood
3 row hog bristle brush
Conductive plastic ESD safe bristles on reinforced plywood. Handle 120mm
Bristle 12mm

Code
HT2021



BRUSH DUSTER SCRUBBER MINI

HOG BRISTLE 4" CLEANER

Static neutral plywood
single row hog bristle flat, wide head design Compact quality tool Long life hog bristle Length 110mm Head 30mm Wide

Code
HT2027



BRUSH HEAVY-DUTY LARGE

HORSE HAIR 10" SCRUBBER

Static neutral plywood 4 row horse hair brush General utility scrubbing 12mm trim length. Firm, long-life Horse hair. Handle 265mm Bristle 12mm

Code
HT2022



→ Brushes

PAINT BRUSHES

POLY-BRISTLE

Classic paint brush
Wooden handle Quality Nylon bristle clamped wont loose stray hairs
Four popular sizes...

Size	Code
2"	HT9050
3"	HT9075
4"	HT9100



→ Service Aids

↓ PCB

BOTTLE DISPENSER

EMPTY BOTTLE 55ml

Steel tip applicator Squeeze bottle to drip. Plastic opaque container. Suits most cleaning fluids. Test fluid before filling.

Holds Code
55ml BOT55E

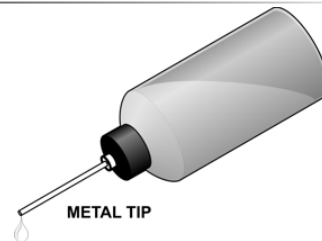

FELT-TIP DISPENSER

Supplied empty with a push-to-release flow tip. Dispense flux, etc.

Code
PEN200



FIBRE PCB TRACK CLEANING PEN

Clean PCBs at the track level eliminating micro-fractures and other general repair diagnosis and inspection.

Code
PEN220

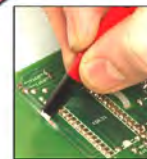

REPLACEMENT TIPS

Code
PRF221

ENGINEER SCRIBER

HIGH-TENSILE STEEL

All metal hand tool for scribing many surfaces. Sharpened point ends. One straight, other bent. 175mm total length. Non-slip grip

Code
HT1824



↓ Cleaning Swabs and Applicators

SCRATCHING HAND TOOLS

PICK & SCRATCH

Contains 6 double sided assorted style & tipped hand tools designed to help solder re-work, Sculpture, clean, etc. Each tool about 150mm

Code
SA10





CHEMTRONICS® SWABS AND APPLICATORS

Professional products designed for servicing consumer electronics with a complete line of ultra-pure swabs and wipes engineered to be highly absorbent and precise. Supplied sealed packaged



COTTONTIPS™

Pharmaceutical grade extremely soft, absorbent, rigid shaft. Pieces 100

Code
CT100



COTTONTIPS™ LOW LINT

Pharmaceutical grade, tightly wound absorbent, general purpose. Pieces 1000

Code
CT5000



COTTONTIPS™ 2 HEAD

Pharmaceutical grade extremely soft, absorbent, both ends. Pieces 100

Code
CT2000



CHAMOIS TIPS™

Ultra-Clean flat swab for Video Heads & Optical pick-ups. Pieces 50

Code
CC50



MICROTIPS™ MEDIUM

Non-abrasive fibre pinpoint for solvent & adhesive applications. Pieces 50

Code
CM502



FOAMTIPS™ #100

Lint-free non-abrasive cellular urethane cleaning swabs. Pieces 50

Code
CF50



FOAMTIPS™ #140

Small Circular Head. For tight hard to reach applications. Pieces 50

Code
CF4050



DAI-1CHI 75mm CHAMOIS SWAB

75mm 10 PIECES

High quality synthetic chamois tipped with 45° angled shaft. Gives easy reach, non-abrasive cleaning for video heads, etc. Packaged in bags of TEN. Approx. 75mm length

Code
VCS10



DAI-1CHI FOAM TIP

150mm 20 PIECES

Ridged wooden shaft Tipped with a sponge Foam applicator, etc.

Code
VCS20



DAI-1CHI COTTON BUDS

150mm 100 PIECES

Ridged wooden shaft white cotton tipped

Code
ACS100



→ Gloves

GLOVES GENERAL PURPOSE COTTON

100% COTTON SOFT

Stretch comfortable. Protect hands and equipment from finger prints, etc. Re-usable, cleanable. One size fits all! Supplied in pairs.

Code
GLV2



GLOVES ESD REUSABLE NYLON

STATIC DISSIPATIVE COATED

Elastic wrist cuffs Palm and finger coated with antistatic urethane for a non-slip grip.

Size	Code
Small	GLV2ESDS
Medium	GLV2ESDM
Large	GLV2ESDL



GLOVES ESD DISPOSABLE

100% NITRILE "SAFE"

Powder free Nitrile examination gloves. Special formula without allergens, silicone, etc. (1V). BSEN455:2000 ISO9002.EN46002. Hypersensitive feel. 50 pairs supplied in a dispenser box.

Size	Code
Small	GLV100S
Medium	GLV100M
Large	GLV100L





14 TOOLS & TEST EQUIPMENT

14 TOOLS & TEST EQUIPMENT

→ Service Aids

↓ Grease Lubricants

SUPER-LUBE SYNTHETIC LUBRICANTS

Super Lube is a patented, multi-purpose, synthetic, exceptionally pure lubricant containing SYNCOLON® (PTFE) particles held in suspension. Super Lube lasts longer and out performs conventional petroleum based greases and oils because there are no impurities or sediments left behind by a crude oil refinement process. It will not oxidize, form gummy carbon deposits or solidify. Temperature tolerance is extended (-43°C to 230°C continuous). Super-Lube also offers improved resistance to water, salt water, acids, alkalies, detergents, conduction and repels dirt, grit, grime, rust, corrosion, etc. It is odourless and non-toxic. Made by Synco in the USA. This new range of lubricant is suitable for the home, workshop or industry and is available in several convenient applicators; As a grease in tubes or slightly more malleable lubricant in a can or syringe. PTFE = Polytetrafluoroethylene (Teflon) www.super-lube.com



SUPER-LUBE IN A CAN 170g

Lubricates, protects, clear, will not stain, bio-degradable, impervious to salt water, etc. Perfect for outdoor equipment, fishing, tools, tracks, etc.

Code
SL31040

SUPER-LUBE IN A PEN 7ml

Synthetic lubricant in a convenient syringe applicator. Penetrates, lubricates and extends the life of machinery and equipment. Bearings, chains, hinges, zippers, locks, toys, etc.



Code
SL51010

SUPER-LUBE IN A TUBE 85g

Synthetic grease. Highly lubricious, clear and non-toxic. Excellent dielectric. Impervious to salt water.



Code
SL21030

SUPER-LUBE IN A TUBE 12g

Lubricates, protects, clear, will not stain, bio-degradable, impervious to salt water, etc. Perfect for outdoor equipment, fishing, tools, tracks, etc.



Code
SL21010

↓ Silicone

HELMAR SILICONE SPRAY

Industry leader Lubricates & Protects Non-staining. Suitable for home, sporting, automotive, industrial.

Size Code
300g H4000



↓ Cleaning Swabs and Applicators

CONTACT CLEANING STRIPS

ELECTROLUBE cleaning, lubricating and protecting treatment. For relay and non-wiping contacts like edge connectors, etc. 20 pcs. 75mm strips.



Code
CCS020

↓ Aerosols

SMOKE DETECTOR TESTER

LIFE SAVER SMOKE DETECTOR TESTER

Designed for testing Ionisation and Photoelectric type. Smoke alarms and detectors. Up to 200 sprays (100g net). CFC Free. Note :- Road transport Only.



Code
LIFLT711

↓ Freezer

FREEZER

-55°C for fault finding, etc. Low residue. Spray cans.

Brand	Size	Code
CRC	300g	CRC2039
RF	250ml/250g	RF59
Electrolube	200ml/225g	FRE200
Electrolube	400ml/450g	FRE400H
ESD	200ml/225g	MCF200
ESD	400ml/450g	MCF400



↓ Aerosols

DUST-BLOWER

AIR BRUSH CANS Cans of inert gas

Brand	Size	Code
CRC Australia	300g	CRC2066
RF Australia	250g	RF67
Electrolube UK	400ml/445g	EAD400



CONTACT CLEANER

NON-SILICONE BASE (protective film residue)

Description	Size	Code
150g Popular contact cleaner lubricant 2-26	150g	CRC2004
500g Popular contact cleaner lubricant 2-26	500g	CRC2005
Contact Cleaner Lubricant	250ml/175g	RF64
Displace moisture, penetrate, lubricate. Protek	250ml/175g	RF68
Electrolube Contact Cleaner Lubricant	200ml/140g	EML200F
Electrolube Contact Treatment Oil Aerosol	200ml/300g	SOB200M
Dry-Glide Dry film lubricator - Teflon Dupont	150g	CRC3040
300g Switch cleaner / lubricant	300g	CRC2001

SILICONE BASED (Si)

Description	Size	Code
Helmar Silicone Lubricant	300g	H4000
CRC Silicone. Lubricates, waterproofs & leaves a clear film for continued protection.	300g	CRC2094



NON-RESIDUE TYPES

Description	Size	Code
Precision Cleaner. No flash point. No residue	200g	CRC2012
CO contact cleaner which evaporates completely	350g	CRC2016
Cleaning Solvent	400ml	IPA400H
Isopropanol	325g	
Ultrasolve Spray Can	400ml	ULS400D
	325g	
Video / Audio Head Cleaner Spray Can	100ml	VID400M



SELLEYS RP7

Multi-purpose lubricating and penetrating spray which displaces water and inhibits corrosion. Plastics rubber safe.

Code
SEL03





Beware! The propellants used in some aerosol products may be flammable. Do Not spray at a Naked Flame!
Government regulations classify aerosols as "dangerous goods". As a result we can not send aerosols by air freight or mail.
Therefore please allow extra time for deliveries containing these products as they can only be transported by road.



CRC® RANGE OF SERVICE AIDS

A long established company who has been manufacturing service aids for many years.
Australian made. Complies with all CFC regulations. See Warning

Description	Size	Code
300g Switch cleaner / lubricant	300g	CRC2001
150g Popular contact cleaner lubricant 2-26	150g	CRC2004
500g Popular contact cleaner lubricant 2-26	500g	CRC2005
Precision Cleaner. No flash point. No residue	200g	CRC2012
CO contact cleaner which evaporates completely	350g	CRC2016
Lectra clean. Heavy duty cleaner and degreaser	400g	CRC2018
CRC Freeze spray. Inert coolant	300g	CRC2039
Plasticate 70. Dry flexible film on most surfaces	300g	CRC2043
Red urethane seal. Insulating and protective varnish	300g	CRC2044
Clear urethane seal. Insulating & protective varnish	300g	CRC2049
Air Brush for dry safe multi-purpose cleaning	300g	CRC2066
GLASS Antistatic cleaner for TUBE type displays	200g	CRC3070
Zinc It. Forms a tough & flexible anti-rust coating	350g	CRC2085
CRC Silicone. Lubricates, waterproofs & leaves a clear film for continued protection.	300g	CRC2094
Dry-Glide Dry film lubricator - Teflon Dupont	150g	CRC3040
Silicone 808 Multi-purpose Enhancer Lube' Protect	330g	CRC3055



RF® SERVICE AIDS

Made in Australia, the RF range of service aids is COMPLETELY OZONE SAFE.

Description	Size	Code
Heat Sink Compound Syringe. Non-Silicone	10ml	RF44
Electronic Cleaning Solvent No1. Safe on plastics	250ml/175g	RF58
Electronic Freezing Spray	250ml/250g	RF59
Video Head Cleaner	250ml/175g	RF60
Circuit Board Lacquer. Forms a flexible coating	250ml/175g	RF61
Contact Cleaner Lubricant	250ml/175g	RF64
Circuit Board Cleaner. For heavy duty cleaning..	250ml/175g	RF65
Air Duster. For removal of dust and dirt	250g	RF67
Displace moisture, penetrate, lubricate. Protek	250ml/175g	RF68



ELECTROLUBE® MAINTENANCE PRODUCTS

ELECTROLUBE products are market leaders and are of the highest import quality. All products comply to Australian government CFC regulations and are ozone friendly. Please read the warning above.

Description	Size	Code
Anti-Static Foam Cleanser Aerosol	400ml/395ml	AFC400H
Anti-Static Squeegee - Vinyl Cleaner	250ml	ASA250
Contact Cleaning Strips	20 strips./packet	CCS020
Clear Protective Lacquer Aerosol	200ml/100g	CPL200H
Dry Film Lubricant Aerosol	200ml/160g	DFL200D
Air Duster Aerosol	400ml/445g	EAD400
Electronic Cleaning Solvent Aerosol	200ml/135g	ECSP200D
Oil in an Application Pencil	5ml	EML05P
Electrolube Contact Cleaner Lubricant	200ml/140g	EML200F
Permaguard Aerosol	200ml/170g	EPE200H
Flux Remover	400ml/325g	FLU400D
PCB Cleaner Foam with brush	400ml/390g	SWA400H
Label remover (lifts stucky goo)	200ml/165g	LRM200D
225g Freezer Aerosol	200ml/225g	FRE200
450g Freezer Aerosol	400ml/450g	FRE400H
250g Freezer Aerosol Anti-static	200ml/225g	MCF200
450g Freezer Aerosol Anti-static	400ml/450g	MCF400
Heat Transfer Compound Syringe	35ml / 70g	HTC35SL
Cleaning Solvent Isopropanol	400ml 325g	IPA400H
Ultrasonic Spray Can	400ml 325g	ULS400D
Rubber Roller Restorer	250ml/195g	RRR250
Silicone Grease Compound Spray Can	200ml/145g	SCO200D
Silver Conductive Paint Bottle	3g Phial	SCP03B
Contact Treatment Grease Syringe	35ml/35g	SGB35SL
Rework Solder Flux non-corrosive free flux	200ml/170g	SMFL200D
Electrolube Contact Treatment Oil Aerosol	200ml/300g	SOB200M
Special Plastic Grease Syringe	35ml	SPG35SL
Conformal Coating Aerosol	200ml/160g	DCA200H
Poly-Urethane Coating DEF STAN 59-47	400ml/275g	PUC400
Positive Photo Resist Aerosol	200ml/210g	PRP200
Developer Positive Photo Resist Bottle	250ml/300g	PDN250
Syringe Clear Silicone Grease Compound	35ml	SCO35SL
Video / Audio Head Cleaner Spray Can	100ml	VID400M
Electrolube range catalogue for product details		ELECAT



CATALOGUE AVAILABLE FREE !



Order Code:
ELECAT





→ Screws



WIDE PAN HEAD SELF TAP

BAG OF 100 PCS

Black zinc plating case hardened
Carbon steel 1022a Pack of 100 pcs.

Size	Code
3.9x13mm	STP3913
3.9x19mm	STP3919
3.9x25mm	STP3925
4.2x38mm	STP4238



BUTTON HEAD SELF TAP

BAG OF 100 PCS

Black zinc plating case hardened
Carbon steel 1022a Pack of 100 pcs.

Size	Code
3.9x13mm	STB3913
3.9x25mm	STB3925
4.2x32mm	STB4232



HEX WASHER HEAD SELF TAP

BAG OF 100 PCS

Black zinc plating case hardened
Carbon steel 1022a Pack of 100 pcs.

Size	Code
3.9x13mm	STH3913
3.9x16mm	STH3916
3.9x22mm	STH3922



COUNTER-SUNK SELF TAP

BAG OF 100 PCS

Case hardened carbon steel zinc plated
Suit MDF/HDF Chipboard 1022a 100pcs

Size	Code
4.0x13mm	STC4013
4.0x19mm	STC4019
4.0 x 25mm	STC4025
4.0 x 32mm	STC4032
4.5 x 45mm	STC4545



WIDE PAN HEAD SELF DRILLING

BAG OF 100 PCS

Gold zinc plating case hardened
Carbon steel 1022a Pack of 100 pcs.

Size	Code
3.9x13mm	SDP3913
3.9x16mm	SDP3916
3.9x22mm	SDP3922



HEX WASHER HEAD SELF DRILLING

BAG OF 100 PCS

Gold zinc plating case hardened
Carbon steel 1022a Pack of 100 pcs.

Size	Code
3.9x13mm	SDH3913
3.9x16mm	SDH3916
3.9x22mm	SDH3922



SCREW GAUGE CONVERSION

Metric to Imperial Gauge guide Note, Screw pitch may also differ.

Nominal Gauge Diameter mm Clearance Hole Pilot Hole

Nominal Gauge	Diameter mm	Clearance Hole	Pilot Hole
6G	3.5mm	3.6mm	1.6mm
7G	3.9mm	4.0mm	1.6mm
8G	4.2mm	4.4mm	2.0mm
10G	5.0mm	5.2mm	2.0mm

MDF & WOOD SCREWS

Fine Thread Counter-Sunk Bugle-Head

Size	Code
7G x 20mm	SBHP720
7G x 25mm	SBHP725
7G x 30mm	SBHP730
7G x 35mm	SBHP735
7G x 50mm	SBHP750
8G x 50mm	SBHP850
8G x 63mm	SBHP863



WOOD & METAL SCREWS

BAG OF 100x SCREWS

Washer-head Needle Points
Hex-head 1/4" (6.35mm) screws

Size	Code
8G x 12mm	SBTN812
8G x 25mm	SBTN825
8G x 32mm	SBTN832



METAL SCREWS

BAG OF 100x SCREWS

Pan-head Needle Point
Details see section 18 CAR
AUDIO ACCESSORIES

Size	Code
6G x 20mm	SPNP620
6G x 30mm	SPNP630
6G x 50mm	SPNP650



METAL SELF-DRILL SCREWS

BAG OF 100 SCREWS

Wafer Head Self-Drill
Metal work screws Fine
Threaded Zinc yellow

Size	Code
10G x 22mm	SWTS1022
10G x 30mm	SWTS1030



WOOD & METAL SCREWS

BAG OF 20x HEX HEAD SCREWS

Hex-head 1/4" (6.35mm) Phillips head
Suit medium and high density MDF Black
anodised finish. Supplied 20 per packet.

Size	Code
8G x 20mm	STS7B
10G x 25mm	STS8B



ALLEN KEY SELF-TAPPING SCREWS

Metric head 3mm I/D
Round Outer 7mm O/D
Self-Tap around 4mm
20mm in depth/length
Supplied bag of 20x
Black in colour

Size	Code
4mm	AS420-20





→ Screws

HEX HEAD BOLTS 8MM

5mm Bolt & 0.8mm Thread
HEX HEAD BOLT (ONLY)

Size	Code
M5x12mm	HB0812
M5x26mm	HB0826
M5x40mm	HB0840

HEX NUT & WASHER

Metal with Inbuilt nylon locking collar

Size	Code
M5(8mm)	HNW508



HEX HEAD BOLTS 10MM

7mm Bolt & 1.0mm Thread
HEX HEAD BOLT (ONLY)

Size	Code
M6x12mm	HB1012
M6x26mm	HB1026
M6x40mm	HB1040

HEX NUT & WASHER

Metal with Inbuilt nylon locking collar

Size	Code
M6(10mm)	HNW610



HEX HEAD BOLTS 13MM

9mm Bolt & 1.25mm Thread
HEX HEAD BOLT (ONLY)

Size	Code
M8x12mm	HB1312
M8x26mm	HB1326
M8x40mm	HB1340

HEX NUT & WASHER

Metal with Inbuilt nylon locking collar

Size	Code
M8(13mm)	HNW813



NUT & BOLT KITS

BAGS OF NUTS/BOLTS/WASHERS

Pan head Posi Bolt x50
 Nut x50 & Washer x50

M3 [3mm Hole]

Size	Code
3mm	M350KB

M4 [4mm Hole]

Size	Code
4mm	M450KB



NUTS & BOLTS

M3 NUTS

Size	Code
3mm	YC85

M3 SCREWS

Size	Code
3mm	YC81

M3 WASHERS

Size	Code
3mm	YC83

M3 SPRING WASHERS

Size	Code
3mm	YC84



100X 14 SCREW TYPES

case with removable compartments each containing popular self tapping screws.

Tool box: 420x340x60mm
 Button Tek 8G x 12/25/32mm
 Pan Head 6G x 20/30/50mm
 Bugle Head 7G x 20/25/30/45mm
 Bugle Head 8G x 63mm Washer
 Head 8G x 15/25/30mm Attache

Code
SCRP14



1400 PIECES

→ Hand Tools

↓ Miscellaneous

POP RIVET TOOL

HAND TOOL GRIPWELL
 25mm long Aluminium diecast
 With changeable nosepieces
 Suits 3/32, 1/8, 5/32, 3/16"
 2.5mm 3.2mm 4mm 5mm
 (x15 ea.) Kit includes 60x
 Rivets & box.

Code
PA26448



SHORT BLIND RIVETS

Head 3.2mm x 6mm
 Aluminium rivets Steel pins (40mm)
 Bag of 100 pieces

Code
BRVT326

Head 4mm x 10mm

Code
SCPR1



X100

→ Storage Boxes

TACKLE BOX COMPONENT TRAY (04)

7 COMPARTMENTS

175x145x35mm
 Plastic tray storage
 bin for holding
 small items.

Code
PSC1003



TACKLE BOX COMPONENT TRAY (04)

17 COMPARTMENTS

275x180x40mm
 Plastic tray storage
 bin for holding
 small items.

Code
PSC1005



TACKLE BOX COMPONENT TRAY (04)

32 COMPARTMENTS

290x220x75mm
 Double sided.
 With removable
 walls. 2 Lids.
 Carry handle.

Code
PSC1006



TOOL BOX (04)

19" WITH TRAY

480x230x210mm
 Plastic. lockable.
 Internal tray

Code
TC1007



MINI-ATTACHE TOOL CASE (04)

SOFT SIDED TEAR-PROOF VINYL

Size 400 x 300 x 60mm
 Elastic tool grips, large & small.
 For screw drivers, hand tools, etc.
 Inside pockets and removable pallet.
 Black and Dark green in colour.

Code
AT963





→ Power Tool

↓ Jigsaw Blades

JIGSAW BLADES MAKITA

3 BLADES PER PACK

Replacement blades to suit Makita Type Jigsaws. Bi-metallic. Available in different course patterns for different materials.

Description	Tooth	Pitch	Length	Code
Soft metals, stainless steel, Epoxy	1.1mm	21tpi	80mm	JSB1M
Soft metals, stainless steel, Epoxy	2.0mm	12tpi	80mm	JSB2M
Hardwood, softwood, laminate, etc.	3.0mm	8tpi	100mm	JSB3M
Hardwood, softwood, Plastics, etc.	2.0mm	12tpi	76mm	JSB4M

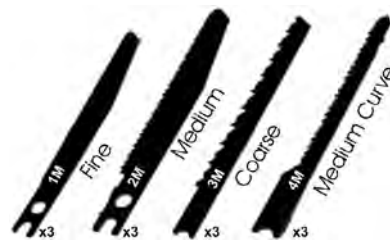

JIGSAW BLADES T-SHANK

BOSCH METABO DEWALT MAKITA AEG ELU etc. Pack of three

Replacement blades to suit recent model Jigsaws. Bi-metallic. Available in different course patterns for different materials.

Description	Tooth	Pitch	Length	Code
Soft metals, stainless steel, Epoxy.	1.1mm	21tpi	76mm	JSB1T
Soft metals, stainless steel, Epoxy.	2.0mm	12tpi	76mm	JSB2T
Hardwood, softwood, laminate, etc	4.0mm	6tpi	100mm	JSB3T
Hardwood, softwood, Plastics, etc.	1.4mm	20tpi	76mm	JSB4T

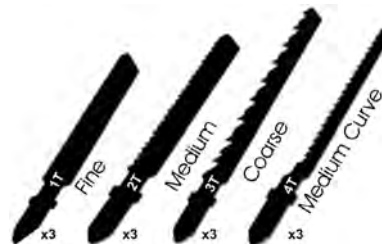

JIGSAW BLADES U-SHANK

BLACK & DECKER SKIL RYOBI HITACHI etc. Pack of three

Replacement blades to suit recent model Jigsaws. Bi-metallic. Available in different course patterns for different materials.

Description	Tooth	Pitch	Length	Code
Soft metals, stainless steel, Epoxy.	1.1mm	21tpi	76mm	JSB1U
Hardwood, softwood, Plastics, etc.	1.4mm	20tpi	76mm	JSB4U



↓ Drill Bits

TITANIUM COATED HSS DRILL BITS

INDIVIDUAL DRILL BITS

Excellent replacement solution for your popular drill bits. Re-fill missing bits from your expensive drill-bit kit box. These professional grade drill bits are made from durable HSS Steel with Titanium Nitrate coating. This technology coating acts as a surface lubricant that reduces friction at the cutting surface and thus heat, this effectively increases the life of the cutting face. Sharpness is maintained longer for a better value drill life. Suitable for drilling most surfaces including metals & alloys.

METRIC SIZES

Diam.	Flute	Length	Angle	Code
1.5mm	18mm	40mm	118°	HSS15
2.0mm	24mm	49mm	118°	HSS20
2.5mm	30mm	57mm	118°	HSS25
3.0mm	33mm	61mm	135°	HSS30
3.5mm	39mm	70mm	135°	HSS35
4.0mm	43mm	75mm	135°	HSS40
4.5mm	47mm	80mm	135°	HSS45
5.0mm	52mm	86mm	135°	HSS50
5.5mm	57mm	93mm	135°	HSS55
6.0mm	57mm	93mm	135°	HSS60
6.5mm	63mm	101mm	135°	HSS65
7.0mm	69mm	109mm	135°	HSS70
7.5mm	69mm	109mm	135°	HSS75
8.0mm	75mm	117mm	135°	HSS80
8.5mm	75mm	117mm	135°	HSS85
9.0mm	81mm	125mm	135°	HSS90
9.5mm	81mm	125mm	135°	HSS95
10.0mm	87mm	135mm	135°	HSS100

IMPERIAL SIZES

Diam.	Metric	Flute	Length	Angle	Code
1/8"	3.12mm	36mm	65mm	135°	HSS18
1/8"	3.12mm	36mm	65mm	135°	HSS18PK
1/8"	3.12mm	36mm	65mm	135°	CD18

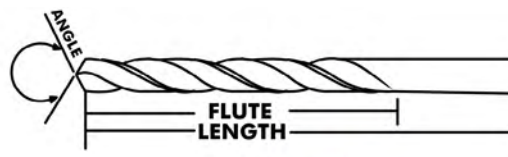



↓ Drill Chucks

REPLACEMENT DRILL CHUCK

THREE-JAW KEYLESS CHUCK

Hammer drills, or battery, or Pneumatic powered tools. Tighten or loosen by hand Nylon sleeve. Steel body. Mount 3/8" x 24 UNF

Size	Code
0.8-10mm	KC31073
2.0-13mm	KC30818



1/4" CHUCK ADAPTOR

EASY CHUCK

Accepts up to 4mm Twist to tighten Quick-fit into standard 1/4" socket Use with drills and hand tools Made in Taiwan

Code
HT2010



↓ Drill Bits

DRILL BIT SET + HEX BITS

POWER TITANIUM DRILL KIT

11 Pieces drills Titanium coated Hardened steel Metric sizes 1.5mm to 10mm PLUS ! 12 Assorted Hex Bits. Phillips, Torx, etc.. HEX Extension piece. Handy storage box.

Code
A8764



3 PIECE STEP DRILL SET

PANEL HOLE CUTTERS

Titanium Nitride Coated Hardened tungsten steel. Dual Flute cutting head. Equivalent to 23 pieces. Ideal for panel drilling. Auto de-burrs the holes. Quick-change 1/4" HEX bits. Popular sizes 3mm to 20mm in three different bits.

Code
HT13847



19 PIECE METRIC DRILL BIT SET

PREMIUM GRADE BITS

Titanium Nitride Coated. Extra long life and extra High speed drill set. Quality and professional. Packaged in a metal box. 19 Metric sizes for drilling wood, metal and plastic, etc. 1.00mm → 10.00mm (0.5mm increments) Pieces 19x

Code
DB13845



11 PIECE HOLE SAW KIT

19mm TO 64mm x8

Comprises two mandrel bits A Pilot bit for the larger Steel circle cutters x8 Sizes: 64mm (2 1/2"), 51mm (2"), 44mm (1 3/4"), 38mm (1 1/2"), 28mm (1 1/8"), 22mm (7/8"), 19mm (3/4")

Code
HT22095



173 PIECE CONCRETE SET

BOSCH SCREW/PLUG/BIT KIT

Handyman solution in-a-box Tool kit with bits & screws Includes four popular size Masonry bits 5, 6, 7 & 8mm With wall plugs to suit each A selection of self-tapper, counter-sunk screws to suit Complete for hanging pictures installing brackets, etc. Bonus HEX bit & driver bit.

Code
HTK173



HOLE SAW 60MM & 92MM

DOWNLIGHT INSTALLATION KIT

Comprises mandrel & pilot bit Plus 2x Steel circle cutters. Popular sizes for installing Low voltage down-lights, etc. Cuts gyprock, plywood, etc. Sizes 70mm and 92mm

Code
HT22100



BOSCH COMPACT TOOL KIT

34 PCS MIXED DRILL, SOCKET AND SCREWDRIVERS ACCESSORY SET

High Quality Multipurpose tool kit. 3 socket wrenches 7/8/10mm + adaptor 1 magnetic universal holder, 1 countersink bit Screwdriver bits PH 1/2/3 Screwdriver bits PZ 1/2/3 Screwdriver bits S 4/6/7 Screwdriver bits T 15/20/25/30 5 wood drill bits 4-8mm 5 HSS metal drill bits 2-5mm 5 masonry drill bits 5-8mm Size: 165x175x45mm

Code
HTX34TI



CEILING CUTTER

ADJUSTABLE 40 to 270mm

Dual, replaceable blades. Pilot hole centring for cutting from both sides giving a maximum of 50mm thickness. Spring loaded clear cowling holds place. Suitable for plaster board & other soft wall & ceiling materials. Suits any standard power or cordless drills.

Code
PAX265

BLADES TO SUIT

Replacement Blades

Code
PAB266





→ Inspection Cameras

SNAKE INSPECTION CAMERA USB

REQUIRES LAPTOP

IR Illuminated camera connects to USB Computer as a WEBCAM for viewing.

Camera VGA CMOS 640x480px
Lens Field Of View 54°
Focus 60mm to Infinite
Neck 600mm x 8.5mmØ
Tip 50x14mmØ
Total 880mm Long

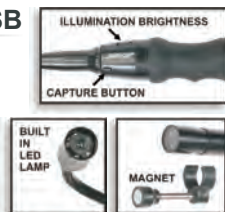

Code
USB206



SNAKE INSPECTION CAMERA 2.4" PRO

VGA RESOLUTION WITH VIDEO OUTPUT & CARRY CASE

1 Metre long metal gooseneck 7mmØ
10mmØ CMOS Camera F2.8 FOV 54°
LED Illuminated brightness adjust
Submersible head & neck IP67
80x80x60mm IP22 casing
2.4" LCD 234x320px
NTSC Video output RCA
Requires 4x "AA"

Code
GB7810

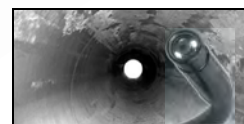

SNAKE INSPECTION CAMERA 2.4"

INLINE STYLE 480x234px

1 Metre long metal gooseneck 7mmØ
9mmØ CMOS Camera FOV 45°
LED Illuminated brightness adjust
IP67 Submersible head & neck
200x85x60mm casing
2.4" LCD 234x480px
Hook, mag, mirror tips
Requires 4x "AA"

Code
G6000



SNAKE INSPECTION CAMERA 2.7"

RECORD & ZOOM 640x480px

1 Metre long metal gooseneck 7mmØ
9mmØ CMOS Camera FOV 36°
LED Illuminated brightness adjust
IP67 Submersible head & neck
263x86x49mm casing
2.7" LCD 640x480px
Hook, mag, mirror tips
Requires 4x "AA"
Recordable image VGA
Requires MicroSD card
USB video file transfer
Video RCA Output

Code
G8000



SNAKE INSPECTION CAMERA 2.5" WIRELESS

REMOVEABLE MONITOR WITH CONTROL

1 Metre long metal gooseneck 7mmØ
9mmØ CMOS Camera FOV 36°
LED Illuminated brightness adjust
IP67 Submersible head & neck
195x165x55mm pistol casing
Detachable wireless monitor
2.4" LCD 234x480px
Hook, mag, mirror tips
Pistol Requires 4x "AA"
Monitor inbuilt rechargeable
Mains charger included

Code
G9000

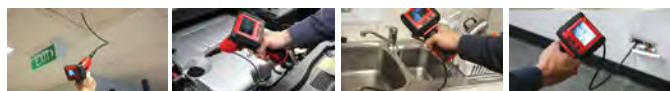

SNAKE INSPECTION CAMERA 3.5" WIRELESS

RECORDING & ZOOM WITH CARRY CASE

1 Metre long metal gooseneck 7mmØ
9mmØ CMOS Camera FOV 36°
LED Illuminated brightness adjust
IP67 Submersible head & neck
195x165x55mm pistol casing
Detachable wireless monitor
3.5" LCD 640x480px
Hook, mag, mirror tips
Pistol Requires 4x "AA"
Monitor inbuilt rechargeable
Mains charger included
Recorder function to
MicroSD Card required.
Video output to RCA
USB for file transfer
Digital zoom. OSD.
Includes carry case.

Code
G9500HC



EXTENSION CABLE

1 METRE GOOSENECK

Suits G6000, G8000,
G9000, G9500HC

Code
EC1



CAMERA HEAD UPGRADE

5mm DIAMETER HEAD

Extra flexible camera head solution.
IP65. 640x480px CMOS CCD

Code
CH55

