



## SECTION 18

# CAR AUDIO ACCESSORIES



# 18

# CAR AUDIO ACCESSORIES

### SECTION CONTENTS

→ Speakers	2
↓ Nakamichi	2
↓ Subwoofers	4
↓ Dual Cone	7
↓ Marine	7
↓ Speaker Spacers	8
↓ Speaker Boxes / Enclosures	10
→ Installation & Accessories	12
↓ Crossovers	12
↓ RCA Plugs & Adaptors	12
↓ Speaker Box Ports	12
↓ Speaker Grilles	13
↓ Carpets / Cloth / Sound Deadener	13
↓ In-Dash Mounting Kits X Ref	14
↓ Mobile Phone Holders	16
↓ Bluetooth	16
↓ Mounting Brackets	16
↓ LCD Mounting Brackets	22
↓ Audio Visual Accessories	23
↓ Reversing Sensors / Cameras	23
↓ LCD Monitors	24
→ Lighting	28
↓ Light Sticks & Flexible Light Strips	29
↓ Misc Decorative	30
↓ Interior Lights	31
→ Interconnects & Wire	32
↓ Amp Wiring Kits	32
↓ Power Cable	34
↓ Accessories	34
↓ Speaker Cables	35
↓ Audio / RCA Cable	35
→ Power	36
↓ Capacitors	36
↓ Noise Filter	36
↓ 12VDC Power Accessories	36
↓ 24VDC to 12VDC Reducers	38
↓ Battery Isolator	38
↓ 12VDC to 240VAC Invertors	39

### SECTION CONTENTS

→ Interconnects & Wire	40
↓ Crimp Terminals	40
↓ Audio / RCA Cable	41
↓ RCA Plugs & Adaptors	41
→ Installation & Accessories	41
↓ LED & LAMPS	41
↓ Relays	41
↓ Converters / Isolators	42
↓ Crossovers	42
↓ AV Switch Box	42
↓ Adaptors / FM Transmitters	43
↓ TV Tuner / System Converters	44
↓ Reference	45
→ Car Hands Free Kits	45
↓ Bluetooth	45
↓ ISO Speaker Interrupter	45
→ Reference	45
→ Fuses & Holders	46
→ Distribution Blocks	48
→ Battery Terminal and Accessories	48
→ Interconnects & Wire	49
↓ Crimp Terminals - Gold Plated	49
↓ Banana Plugs & Alligator Clips	49
↓ Automotive Switches	50
↓ 12VDC Plugs & Sockets	50
↓ Cross-Over Components	51
→ Installation & Accessories	52
↓ Pop Rivets & Tool	53
↓ Cable Management	53
↓ Tapes	53
↓ HeatShrink	54
↓ Cable Management	54
↓ Tools	56
↓ Harness- Quick Disconnect	58
↓ Harness - ISO Audio	59
↓ Harness - OEM Audio Bare Wire	63
→ Antennas	66
↓ AERPRO CROSS-REFERENCE	77



## ↓ Speakers Nakamichi

### NAKAMICHI 4" 2 WAY SPEAKERS

Superior product design, acoustic quality and performance.  
Product innovation, advanced technology in-car entertainment system.

Composite Cone Woofer  
20mm Neodymium Magnet Silk Dome Tweeter  
25mm KAPTON Voice Coil  
Frequency Response: 90Hz to 20Khz  
Magnet Weight: 152g (5.4 Oz)  
RMS Power: 30W  
Peak Power: 100W  
Impedance: 4 Ohm  
SPL (1m/W): 86dB

Code  
SPH42



### NAKAMICHI 6" SPLIT SPEAKERS

6" 152mm Component Speakers  
PP-MICA Rubber Edge Woofer  
25mm KAPTON Voice Coil  
Separate Silk-Dome Tweeter  
25mm Neodymium Magnet  
Frequency Response: 60Hz to 20Khz  
Magnet Weight: 350g (12 Oz)  
RMS Power: 50W  
Peak Power: 280W  
Impedance: 4 Ohm  
12dB Crossover Network  
SPL (1m/W): 89dB

Code  
SPCS650



### NAKAMICHI 6" 2 WAY SPEAKERS

6" 152mm 2 Way Coaxial Speakers  
PP-MICA Cloth Edge Woofer  
13mm Neodymium Magnet PEI Dome Tweeter  
25mm KAPTON Voice Coil  
Frequency Response: 80Hz to 20Khz  
Magnet Weight: 250g (8.9 Oz)  
RMS Power: 30W  
Peak Power: 180W  
Impedance: 4 Ohm  
SPL (1m/W): 89dB

Code  
SPC602



### NAKAMICHI 12" 305MM SUB 200W RMS

12" 305MM SUB 200W RMS  
PP-MICA Rubber Edge Woofer  
Frequency Response: 30Hz to 1.5KHz  
Magnet Weight: 1208.4g (42.7 Oz)  
50mm ASV Voice Coil  
Single Voice Coil: 4 Ohm  
RMS Power: 200W  
Peak Power: 1000W  
Impedance: 4 Ohm  
SPL (1m/W): 87dB

Code  
SPW12S



### NAKAMICHI 6"X9" 3 WAY SPEAKERS

6X9" 152mm X 238mm 3 Way Triaxial Speakers  
PP-MICA Cloth Edge Woofer  
50mm Black Paper Cone Midrange  
25mm PIEZO + Mylar Tweeter  
30mm KAPTON Voice Coil  
Frequency Response: 55Hz to 20Khz  
Magnet Weight: 433g (15Oz)  
RMS Power: 50W  
Peak Power: 300W  
Impedance: 4 Ohm  
SPL (1m/W): 90dB

Code  
SPC6093



### NAKAMICHI 12" 305MM SUB 300W RMS DUAL COIL

12" 305mm Subwoofer  
Dual Voice Coil: 4 Ohm + 4 Ohm  
Frequency Response: 30Hz to 1.5KHz  
Magnet Weight: 1151.2g (53.4 Oz)  
PP-MICA Foam Edge Woofer  
50mm ASV Voice Coil  
RMS Power: 300W  
Peak Power: 1200W  
Impedance: 4 Ohm

Code  
SPW120D





↓ **Nakamichi**

### NAKAMICHI PL CAR AMP 300W X1

1 Channel Class A/B Power Amplifier  
 1 x 300W RMS @ 4 Ohm  
 1 x 400W RMS @ 2 Ohm  
 10Hz to 180Hz > 98dB (THD) < 0.1%  
 Low Pass Filter: 40Hz to 180Hz  
 High Pass Filter: 80Hz  
 Bass Boost: 0dB or 12 dB  
 370mm x 212mm x 50mm



Power	Code
1x 300W	PL1300



### NAKAMICHI PM CAR AMP 350W X1

1 Channel Class D Power Amplifier  
 1x 350W RMS @ 4 Ohm  
 1 x 600W RMS @ 2 Ohm  
 32Hz to 320Hz >90dB (THD) < 0.2%  
 Low Pass Filter : 32Hz-320Hz  
 Sub Sonic Filter: 10Hz-100Hz  
 Bass Boost: 0dB to 12dB  
 382mm x 197mm x 58mm



Type	Power	Code
Class D	1x 300W	PM6001



### NAKAMICHI PL CAR AMP 75W X2

2 Channel Class A/B Power Amplifier  
 2 x 75W RMS @ 4 Ohm  
 2 x 150W RMS @ 2 Ohm  
 1 x 210W RMS @ 4 Ohm (Bridged)  
 10Hz to 80KHz > 96dB (THD) < 0.1%  
 Low Pass Filter : 80Hz or 180Hz  
 High Pass Filter : 80Hz  
 Bass Boost: 0dB to 12 dB  
 260mm x 212mm x 50mm



Power	Code
2x 75W	PL275



### NAKAMICHI PM CAR AMP 500W X1

1 Channel Class D Power Amplifier  
 1x 500W RMS @ 4 Ohm  
 1 x 1000W RMS @ 2 Ohm  
 1 X 1400W RMS @ 1 Ohm  
 20Hz to 320Hz >90dB (THD) < 1%  
 Low Pass Filter : 32Hz - 320Hz  
 Sub Sonic Filter: 10Hz - 100Hz  
 Bass Boost: 0dB to 12dB  
 382mm x 197mm x 58mm



Type	Power	Code
Class D	1x 500W	PM14001



### NAKAMICHI PL CAR AMP 150W X2

2 Channel Class A/B Power Amplifier  
 2 x 150W RMS @ 4 Ohm  
 2 x 280W RMS @ 2 Ohm  
 1 x 400W RMS @ 4 Ohm (Bridged)  
 10Hz to 80KHz 96dB (THD) < 0.1%  
 Low Pass Filter : 80Hz or 180Hz  
 High Pass Filter (F): 80Hz  
 Bass Boost: 0dB or 12 dB  
 450mm x 212mm x 50mm



Power	Code
2x 150W	PL2150



### NAKAMICHI PM CAR AMP 125 X2

2 Channel Class A/B Power Amplifier  
 2 x 125W RMS @ 4 Ohm  
 2 x 200W RMS @ 2 Ohm  
 1 x 400W RMS @ 4 Ohm (Bridged)  
 10Hz to 50KHz >95dB (THD) < 0.1%  
 High/Low Pass Filter: 32Hz - 320Hz  
 Bass Boost: 0dB to 6 dB  
 352mm x 97mm x 58mm



Power	Code
2x 125W	PM2502



### NAKAMICHI PL CAR AMP 60W X4

4 Channel Class A/B Power Amplifier  
 4 x 60W RMS @ 4 Ohm  
 4 x 100W RMS @ 2 Ohm  
 2 x 180W RMS @ 4 Ohm (Bridged)  
 10Hz to 80KHz >96dB (THD) < 0.1%  
 Low Pass Filter (R): 80Hz  
 High Pass Filter (F): 80Hz  
 Bass Boost: 0dB or 12 dB  
 370mm x 212mm x 50mm



Power	Code
4x 60W	PL460



### NAKAMICHI PM CAR AMP 75W X4

4 Channel Class A/B Power Amplifier  
 4 x 75W RMS @ 4 Ohm  
 4 x 100W RMS @ 2 Ohm  
 2 x 150W RMS @ 4 Ohm (Bridged)  
 10Hz to 100KHz >95dB (THD) < 0.1%  
 High/Low Pass Filter (F+R): 32Hz-320Hz  
 Bass Boost: 0dB to 6 dB  
 432mm x 197mm x 58mm



Power	Code
4x 75W	PM3004



### NAKAMICHI PL CAR AMP 100W X4

4 Channel Class A/B Power Amplifier  
 4 x 100W RMS @ 4 Ohm  
 4 x 150W RMS @ 2 Ohm  
 2 x 300W RMS @ 4 Ohm (Bridged)  
 10Hz to 80KHz >96dB (THD) < 0.1%  
 High/ Low Pass Filter (F+R): 80Hz  
 Bass Boost: 0dB or 12 dB  
 450mm x 212mm x 50mm



Power	Code
4x 100W	PL4100



### NAKAMICHI PM CAR AMP 100W X4

4 Channel Class A/B Power Amplifier  
 4 x 100W RMS @ 4 Ohm  
 4 x 175W RMS @ 2 Ohm  
 2 x 350W RMS @ 4 Ohm (Bridged)  
 10Hz to 100KHz >95dB (THD) < 0.1%  
 High/Low Pass Filter (F+R): 32Hz-320Hz  
 Bass Boost: 0dB to 12 dB  
 472mm x 197mm x 58mm



Power	Code
4x 100W	PM4004





# 18 CAR AUDIO ACCESSORIES

## → Speakers

## ↓ Subwoofers

### PEERLESS XPANDED-XTRA-LONG-STROKE SUB WOOFERS

#### A NEW CLASS OF HIGH SPL BASS FROM SMALL ENCLOSURES

Extreme performance heavy duty subs that are built for GO not just show. Sound quality competition award winning. Audiophile grade tight clean bass Engineered for faithful reproduction with low distortion at very high SPL Advanced design using patented technologies and superior Q' manufacturing Large over-sized components. Light weight extra strong ridged alloy frame An incredible 50mm cone exertion. Open spider for low compression venting Double stack magnet system optimised by Finite Element Analysis to create a unified symmetric powerful magnetic field producing very high efficiency Xtra-Long multi-layer 2"Ø black anodized aluminium high power voice coil. Unique distortion reducing motor using aluminium shorting ring and spacer. This results in a lower self induction & impedance varying with exertion A unique formula ultra-stiff wood-free pulp cone is also weather resistant Bonded together with a blend of polymers, glass fibres and Nomex® SBR rubber surround gives high travel compliance, low creep and long life. All this combines to produce a sub woofer that is a cut above the rest. Very Low, Smooth & Tight Distortion-Free Bass from very compact enclosures.



#### XLS 10" XTRA-LONG-STROKE 4Ω (2½Ω)

Design principles & the latest materials in the XLS range have achieved a new generation of low-frequency transducer. This range of subwoofers will pound the competition in both low frequency muscle and accuracy. A low Vas means a small box. For car applications this can be very small. Double magnet. Cast Aluminium frame. Ventilated coil. Suit sealed/vented/passive.

Impedance	2.4Ω (Re 1.8Ω)
Power	300Wrms
Sens.	92.2dBm
Fs	39.4Hz
Coil	51mmØ
Qms	6.37
Qes	0.42
Qts	0.39
Vas	21.4L
Code	830514

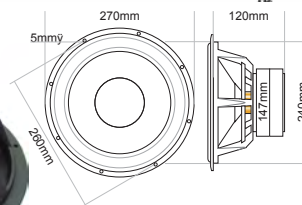

Physical measurements taken from actual stock. Please allow for measurement tolerances. (Approx. ±0.1%) It is recommended that you acquire actual stock before drilling any holes! See [www.p.com.au](http://www.p.com.au) or [www.peerless.de](http://www.peerless.de) for more data.

#### XLS 12" XTRA-LONG-STROKE 4Ω (2.2Ω!)

##### LOW IMPEDANCE

Ballistic performance driver tweaked for use in car audio applications giving you advantages that will annihilate the competition. Specifications are best suited for small enclosure systems with very, very high current output amplifiers (2Ω rated amp required). Very clean. Very smooth. Double magnet. Cast iron frame. Gold 4mm binding posts. Massive sound.

Impedance	28.9Ω (Re 2.2Ω)
Power	300Wrms
Sens.	93.5dBm
Fs	28.2Hz
Coil	51mmØ
Qms	4.81
Qes	0.32
Qts	0.30
Vas	80.5L
Code	830515

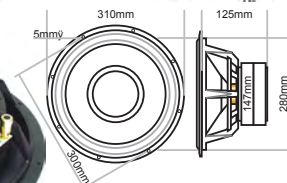

Physical measurements taken from actual stock.

#### XXLS 12" XPANDED-XTRA-LONG-STROKE 4Ω (AI)

##### ALUMINIUM CONE

The new range of Xpanded Xtra Long Stroke (XXLS) subwoofers from Peerless has pushed the performance limits for subwoofers again. XXLS have unexcelled long exertion performance with very low distortion. Mechanically robust, yet highly efficient, low Fs and low Qt. Suitable for small vented boxes.

Impedance	65.7Ω (Re 3.9Ω)
Power	350Wrms
Sens.	91.2dB
Fs	19.1Hz
Coil	51mm
Qms	9.29
Qes	0.38
Qts	0.37
Vas	159L
Code	830952

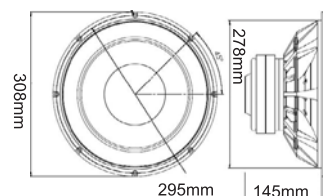
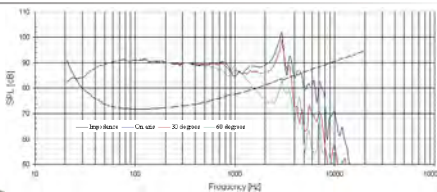



## TARGA AUTOSOUND CAR SUB-WOOFERS

LOOK! CAST IRON FRAME AT STEEL-STAMPED PRICES!

High performance weather resistant paper cone doped and poly dust cap. Butyl rubber roll surround and oversized spider for extra cone travel. Solid die cast alloy basket frame. Gold-plated 4mm binding posts. Black framed over-sized magnet. Long-throw high-power voice coil. Centre-core ventilated system. Premium build quality for automotive or home audio subwoofer applications. Suitable for sealed or vented boxes. Recommended box volumes are minimum only. Larger cabinets will give better bass. Dai-1chi. Reliable quality & High power. Excellent sound for your dollar option.

**DIE-CAST ALLOY**

**HIGH POWER  
LONG THROW  
EXTRA TOUGH  
SUPER PRICE!**

# TARGA AUTOSOUND



### 10" X-100

Size	10"
Power	150Wrms 300Wmax
Impedance	4.6 Ohm
Res.	36.4Hz
Sens.	88dB
Mag.	140x20mm (38oz.)
Qms	2.66
Qes	0.56
Qts	0.47
Vas	45L
Box	0.8 <sup>ft</sup> min.
Code	X100SVC

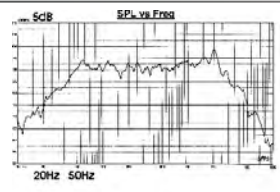

Hole-Cut = 230mm  
Mounting Holes = 243  
Depth = 110mm

**10"**

### 12" X-120

Size	12"
Power	200Wrms 400Wmax
Impedance	4.1 Ohm
Res.	32.3Hz
Sens.	89dB
Mag.	156x20mm (49oz.)
Qms	3.69
Qes	0.61
Qts	0.53
Vas	85L
Box	1.0 <sup>ft</sup> min.
Code	X120SVC

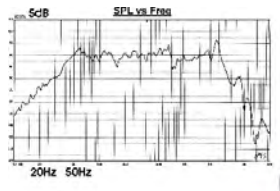

Hole-Cut = 290mm  
Mounting Holes = 300  
Depth = 135mm

**12"**

### 15" X-150

Size	15"
Power	250Wrms, 500Wmax
Impedance	3.9 Ohm
Res.	29.5Hz
Sens.	87dB
Mag.	156x20mm (49oz.)
Qms	4.33
Qes	1.16
Qts	0.92
Vas	159L
Box	1.4 <sup>ft</sup> min.
Code	X150SVC

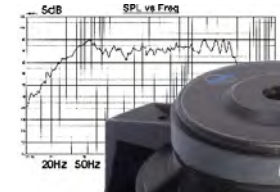

Hole-Cut = 360mm  
Mounting Holes = 372  
Depth = 155mm

**15"**

18 CAR AUDIO ACCESSORIES



# 18 CAR AUDIO ACCESSORIES

18 CAR AUDIO ACCESSORIES

## ↓ Subwoofers

### 8" SUBWOOFER

#### DOPED CONE 200mm

Treated pulp cone for extended low frequency without cone breakup. 2" Aluminium voice coil. Strontium magnet. 80Wrms.

Z	4Ω (3.9Ω)
Freq.	36→8KHz (±3dB)
Fo	36Hz
Sens.	88dB
Mag.	20 Oz
Power	160W max.
Qms	5.45
Qes	0.59
Qts	0.53
Vas	46.1L
Code	CS80

Hole Ø	185mm
Outer Ø	205mm
Mag. Ø	110mm
Depth	90mm

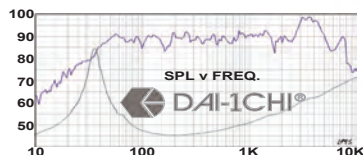

### 10" SUBWOOFER

#### DOPED CONE 260mm

Treated pulp cone for extended low frequency without cone breakup. 1.5" Aluminium voice coil. Strontium magnet. 100Wrms.

Z	4Ω (4.0Ω)
Freq.	35→6KHz (±3dB)
Fo	34.8Hz
Sens.	89dB
Mag.	40 Oz
Power	200W max.
Qms	5.07
Qes	0.47
Qts	0.43
Vas	74.9L
Code	CS100

Hole Ø	235mm
Outer Ø	260mm
Mag. Ø	140mm
Depth	107mm

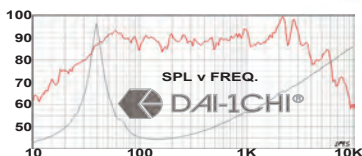

### 12" SUBWOOFER 4Ω

#### DOPED CONE 300mm

Poly' doped cone for extended low frequency without cone breakup. 2" Aluminium voice coil. Strontium magnet. 150Wrms.

Z	4Ω (4.7Ω)
Freq.	25→5KHz (±3dB)
Fo	25.0Hz
Sens.	91dB
Mag.	50 Oz
Power	300W max.
Qms	5.46
Qes	0.35
Qts	0.33
Vas	202.7L
Code	CS120

Hole Ø	270mm
Outer Ø	300mm
Mag. Ø	155mm
Depth	125mm

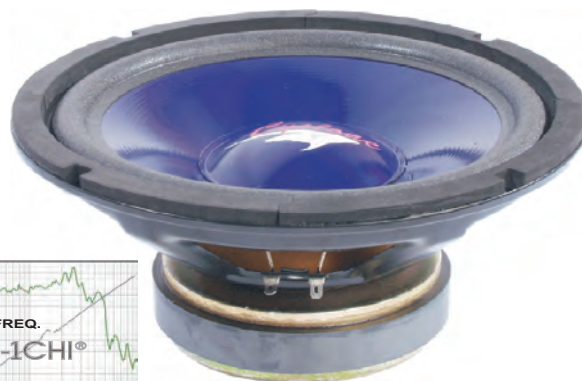
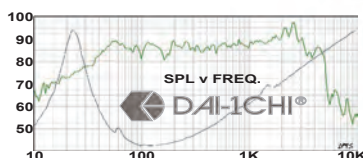

## ↓ Speakers

### 3" MINI-SPEAKER CUBES

#### HOME / PATIO / CAR / BOAT

Weather resistant Stereo Pair Compact 90mm<sup>3</sup> box + Bracket 50W peak 76mm Mid-Woofer 8Ω Longlife polypropylene cone Coaxial mounted piezo tweeter Includes bracket for mounting Ideal for trucks, vans, utes, Surround sound, patio, office and other space limited HiFi

#### Black Pair

Code SA300B

#### White Pair

Code SA300W



### SPEAKER BOX SOLUTIONS

Wedge shaped plastic enclosure speaker box pairs with mounting bracket. Suit Vans, etc. 4Ω

#### 3½" 2way 190x130x110mm

Colour	Code
Black	SA500BA
White	SA500WA

#### 5¼" 2way 240x180x140mm

Black	SA850BA
White	SA850WA

#### 8" 2way 320x230x180mm

Black	SA980B
White	SA980W



More available - See section 6 SPEAKERS



## ↓ Dual Cone

### DUAL CONE OVAL CAR SPEAKER

Size	4x6"
Power	30Wrms
Impedance	4Ω
Freq.	120Hz-20KHz
Fr	120Hz
Voice	20mmØ
Mag.	4.3oz
Code	DC46-30

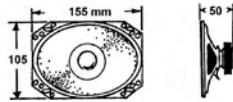

**SOLD IN SINGLES**  
Two required for stereo  
Whizzer cone extends high frequency sound

### DUAL CONE OVAL CAR SPEAKER

Size	5x7"
Power	40Wp-p
Impedance	4Ω
Code	DC57-40

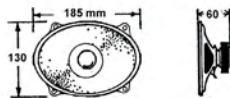
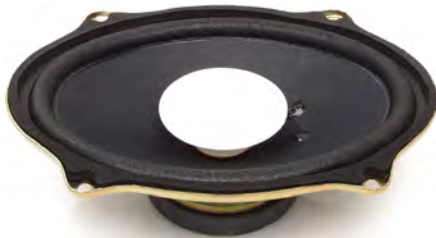

**SOLD IN SINGLES**  
Two required for stereo  
Whizzer cone extends high frequency sound

### 5" DUAL CONE CAR SPEAKER

Size	5"
Power	40Wp-p
Impedance	4Ω
Code	DC525-40

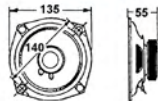

**SOLD IN SINGLES**  
Two required for stereo  
Whizzer cone extends high frequency sound

### 4" DUAL CONE CAR SPEAKER

Size	4"
Power	40Wp-p
Impedance	4Ω
Code	DC4-40

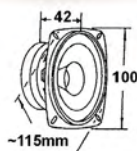

**SOLD IN SINGLES**  
200g magnet Cloth surround  
Two required for stereo  
Whizzer cone extends high frequency sound

## ↓ Marine

### MARINE SPEAKER 5" 2-WAY

2x Single piece white plastic construction.  
Polypropylene cone  
Mylar dome tweeter

Freq.	120Hz → 20KHz
Power	60 Watts
Impedance	4 ohm
Size	122mm
Code	SA502M



### MARINE SPEAKER 6" 2-WAY

2x Single piece white plastic construction.  
Polypropylene cone  
Mylar dome tweeter

Freq.	60Hz → 20KHz
Power	80 Watts
Impedance	4 ohm
Size	165mm
Code	SA602M



### MARINE SPEAKER 7"

#### SINGLE PIECE

White Salt-water resistant. One piece construction.  
Polypropylene driver.  
180mm diameter.  
75W max power. 4Ω.  
5M cable included.  
Suit communications  
Or buy two for audio  
Premium grade from Benelec Australia

Code	MSPK7
------	-------



### MARINE RADIO HOUSING

#### WEATHER RESISTANT

Suits DIN sized units giving full protection from dust & water, etc. Marine white in colour  
Sealed rear cabling Sealed front flip lid UV protection lens  
Suit boats & RVs, etc.

#### FULL HOUSING

Front & Back

Code	FP9003
------	--------

#### FRONT ONLY

Code	FP9005
------	--------





## → Speaker Spacers

### 6" VINYL FIBREGLASS SPACERS

#### 152mm MOUNT PAIR 60mm

Professional install Soft corner advanced style with modern look Reinforced fibreglass Acoustic design housing Sturdy MDF Base panel Base measures 225x225mm Height tilt angle 60mm Parcel shelf add-on or upgrade your door panels. Sold in pairs.

Colour	Code
BLACK	APF60BL
GREY	APF60GR

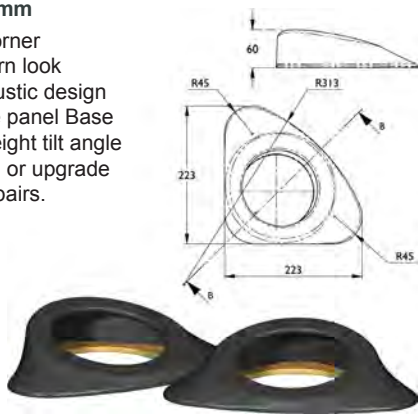

### 6X9" VINYL FIBREGLASS SPACERS

#### 152x229mm MOUNT PAIR 78mm

Long-ways for N/S mount Reinforced fibreglass injected vinyl spacers Sturdy MDF Base panel Base measures 320x230mm Height tilt 21mm to 51mm Suits ledges in hatchbacks near the C pillar or other tight places for bigger sound without cutting bigger holes! Sold in pairs. Box packaged.

Colour	Code
BLACK	APF69LBL
GREY	APF69LGR



### 6" VINYL FIBREGLASS SPACERS

#### 152mm COMPONENT SYSTEM

Professional install Soft corner advanced style with modern look Reinforced fibreglass Acoustic design housing Sturdy MDF Base panel Base measures 235x215mm Height tilt angle 67mm Parcel shelf add-on or upgrade your door panels. Sold in pairs.

Colour	Code
BLACK	APF62BL
GREY	APF62GR



### 6X9" VINYL FIBREGLASS SPACERS

#### 152x229mm MOUNT PAIR 51mm

Professional install Soft corner advanced style with modern look Reinforced fibreglass Acoustic design housing Sturdy MDF Base panel Base measures 320x230mm Height tilt 28mm to 78mm Parcel shelf add-ons Don't cut bigger holes! Sold in pairs.

Colour	Code
BLACK	APF69HBL
GREY	APF69HGR

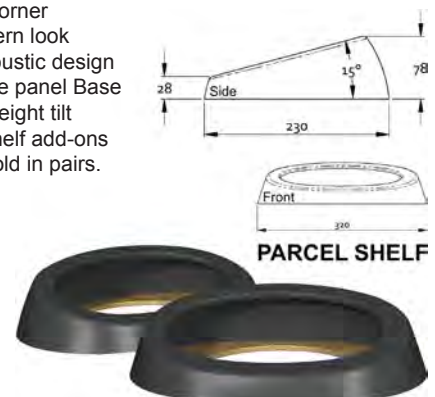

### 6-6½" MOULDED PLASTIC SPACERS

#### 150-170mm MOUNT PAIR 100mm

Reinforced ABS plastic Acoustic design housing Rubberised coated finish Dark grey black colour Sturdy MDF Base panel Base measures 185x220mm Supplied with 6" & 6½" adaptor mounting rings Height angle 100mm to 50mm Easy parcel shelf add-on. Sold in pairs.

Code
APS620RG



### 6x9" MOULDED PLASTIC SPACERS

#### 150x230mm MOUNT PAIR 100mm

Reinforced ABS plastic Acoustic design housing Rubberised coated finish Dark grey black colour Sturdy MDF Base panel Base measures 75x250mm Height angle 100 to 50mm. Excellent solution for easy upgrading smaller 6½" size parcel shelf speakers since no modification holes need be drilled for bigger sound! Low profile as the new 6x9" magnets fit down the replaced 6" speakers existing hole.

Code
APS690SG

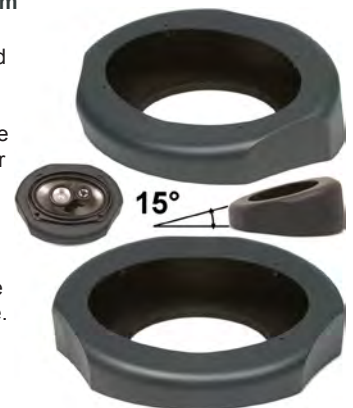

### VT-VY 6X9" SPEAKER GRILLES

#### REPLACEMENT 152x228mm

6x9 Speaker grilles used to replace the original grilles when removing factory fitted speakers. Packed in hang sell, full colour box.

Colour	Code
Grey	VTVY96
Black	VTVY96B



### FORD BA 5X7 MDF ADAPTOR PLATE

#### INSTALL 6" SPEAKERS

1 Pair MDF 5" x 7" Adaptor plates to suit BA Falcon Converts 5 x 7 to 6"

Code
APF57S







## SPEAKER SPACERS MDF

Pre-drilled Medium Density Fibreboard Pairs  
Allows speakers to clear objects behind them

### 16mm THICK SPEAKER SPACERS UNPAINTED

Size	I/D	O/D	Code
4"	110mm	140mm	AP314
5-6"	152mm	160mm	AP3151
6½"	165mm	180mm	AP3161
6x9"	228x152mm	285x187mm	AP3181
6x9" 7x10"	158x230mm	200x268mm	AP3191



### 16mm THICK SPEAKER SPACERS BLACK PAINTED

Size	I/D	O/D	Code
5-6"	152mm	160mm	AP3151B
6½"	165mm	180mm	AP3161B
6x9"	228x152mm	285x187mm	AP3181B
6x9"	178x254mm	272x202mm	AP3191B



## SPEAKER SPACERS CARPETED

**18mm THICK MDF**  
Pre-drilled Sold in pairs Medium Density Fibreboard  
Pre-wrapped in grey or black interior carpet

### GREY CARPET

Size	I/D	Code
6"	152mmØ	AP3061C
6½"	165mmØ	AP3062C
6x9"	152x228mmØ	AP3081C

### BLACK CARPET

Size	I/D	Code
6"	152mmØ	AP3161C
6½"	165mmØ	AP3162C
6x9"	152x228mmØ	AP3181C



## SPEAKER SPACERS ABS PLASTIC

### 5¼"-6½"

Colour	Description	Code
Black	132mmØID 164mmØOD 12mm(H)	AP3165
Black	132mmØID 164mmØOD 25mm(H)	AP316

### 5¼"-6½" TILTED

Colour	Description	Code
Black	152mmØID 164mmØOD 25/12mm(H)	AP3166



### 6x9" SQUARE

Colour	Description	Code
Black	154x222mm 186x260mm 38mm(H)	AP318

### 6x9" ROUND TILTED

Colour	Description	Code
Black	157x225mm 172x248mm 78/38mm(H)	AP317



## 6X9" SOLUTIONS

### 6x9" UNIVERSAL ADAPTOR PLATES

These plates allow you to replace existing 6x9" speakers with smaller 6½"/5¼" speakers  
Upgrade to components. Location for tweeter.  
Black plastic. Sold in pairs.

Code  
AP6901

### 6x9" REAR SPEAKER BAFFLE

For protecting or baffling 6x9" speakers Ideal for hatchbacks, etc. where the rear of the 6x9" speaker is exposed to dust or where poor bass results from no baffling. Add a rear speaker cabinet to tighten bass. Black plastic. Sold in pairs.

Code  
AP6900





## ↓ Speaker Boxes / Enclosures

### 6x9" SPEAKER CABINET

#### SEALED PLASTIC CABINET PAIR

Complete unit pair, just add 6x9" speakers! Put in some big sound for trucks, vans, etc. Quality ABS sealed plastic box 180x190x280mm Screw cable terminals with 4mm banana posts Black. Includes mounting bracket & screws. Wedge shaped for mounting versatility.

Code  
APFB69B



### 6" SPEAKER BOX MDF

#### 205x210x230mm with 125mm Hole

Quality, universal, compact, sealed enclosure. Made from MDF Particle board and covered in attractively finished neutral black carpet. Front hole cut to suit 6" drivers (152mm). Ideal for temporary installations or where mounting drivers for better sound is not possible. Available with port for full range or without port for use with a subwoofer. Sold in pairs.

Code  
SB60A



SPEAKERS NOT INCLUDED  
REQUIRES SPEAKERS

### 6x9" SPEAKER BOX MDF

#### WOODEN CABINETS GIVE A TIMBRAL SOUND

Quality, universal, compact, sealed enclosure Made from MDF Particle board and covered in attractively finished neutral black carpet Front hole cut to suit 6x9" (152x254mm) Outer dimensions 185Hx300Wx200D mm Factory made wooden cabinet filled with acoustic wadding for a warm quality that brings the best from your 6x9" speaker. Attractively wedge shaped matte black. Ideal for temporary installations or where mounting large drivers for big sound is not possible. Sold in pairs.

Code  
SB69A



SPEAKERS NOT INCLUDED  
REQUIRES 6x9" SPEAKERS

### 12" SUB-WOOFER CABINET FOR HATCHBACKS

#### COMPACT LOW-PROFILE MAX-FLAT

Bass box, just add a super 12" Subwoofer. Extra detailing for a more attractive design. Black carpet subwoofer enclosure with extra panelling to give a stronger box for high performance and extra tight bass. Sleek design is practical and functional. Angled for mounting behind rear seats, using a minimum of space. Compact 25 litre (0.85ft³) Ported enclosure. Gold plated 4mm binder & screw terminals. Filled with high-grade acoustic dampening. Excellent no-fuss mega-bass solution. 380x560x240mm

Code  
MAX12





## WEDGE SUB-WOOFER CABINETS GREY CARPET

### CURVED EDGE GREY CARPET - REQUIRES SUBWOOFER

Single Sub Woofer driver (required).  
 Attractively finished in grey carpet wrapped around a wedge box design.  
 Quality constructed MDF board for warm, solid and tight bass sound.  
 Internal foam wadding included.  
 Curved edges for strength and to reduce reverberations, etc. Sealed for simplistic setup, so no port tuning required. Or add a port if required.  
 Spring release terminals.

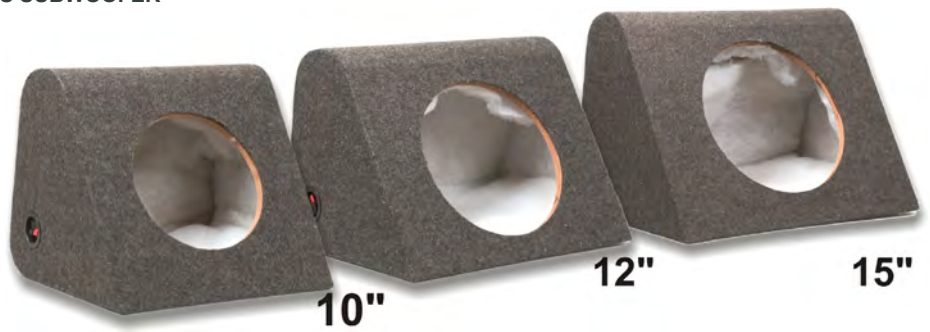

Suit	Size	Volume	Code
10"	400x350x380mm	23L	SB10
12"	475x350x380mm	28L	SB12
15"	605x430x450mm	33L	SB15

## 12" SUB CABINET DUAL

### 2.0 Ft³ REQUIRES TWO SUBWOOFERS

Dual 12" 305mm driver subwoofer enclosure A very popular solution for too much bass! Attractively finished in grey carpet wrapped around a wedge box design. Quality constructed MDF board for warm, solid and tight bass sound. Internal foam wadding included. Curved edges for strength and to reduce reverberations, etc. Sealed for simplistic setup, so no port tuning required. Or add a port if preferred. Spring release terminals.

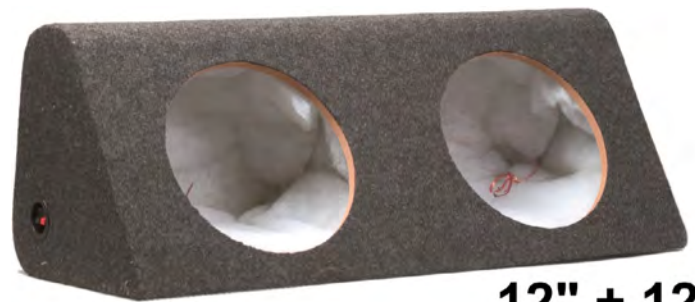

Suit	Size	Volume	Code
12" x2	920x350x380mm (WHD)	56L 2.0Cft	SB12D

## 12" WEDGE SUB-WOOFER CABINETS

### BLACK CARPET BOX - REQUIRES SUBWOOFER

Single 12" 305mm (or 15" 381mm) driver required Attractively finished in grey carpet wrapped around a wedge box design. Quality constructed MDF board for warm, solid and tight bass sound. Internal foam wadding included. Curved edges for strength and to reduce reverberations, etc. Sealed for simplistic setup, so no port tuning required. Or simply drill a port if required.



Suit	Size	Volume	Code
12"	350x460x320mm	28L	SB12100
12"	350x460x320mm	28L	SB12100N
12"	340x335x435mm	20L	PSB12

## 12" SUB CABINET LARGE PORTED

### NEW DELUXE 25L ENCLOSURE

MDF Construction covered in Black Carpet.  
 Supplied with 45cm speaker cable fitted to round terminal board with gold binding posts. Tuning Frequency 50Hz. Maximum Mounting depth of subwoofer : 270mm.

Suit	Size	Volume	Code
12"	370x435x390mm	41L	SPB12

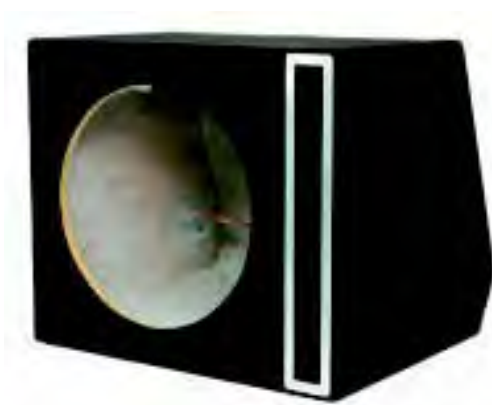



# 18 CAR AUDIO ACCESSORIES

## → Installation & Accessories

### ↓ Crossovers

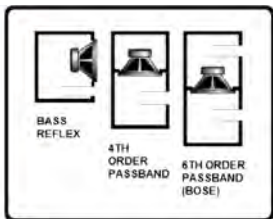
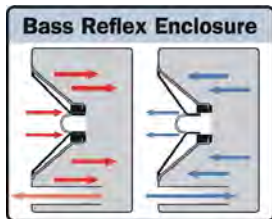

### PASSIVE CROSSOVER

#### 4-OHM 3-WAY

6dB/12dB Slope Switchable  
120 Watts Maximum power  
Crossover 600Hz & 5KHz  
Gold screw terminals



Colour	Size	Code
Black	90x130x30mm x2	APS10X

### SUBWOOFER X-OVER

Stereo 12dB Low-pass active filter. Compact design for adapting a subwoofer to your system. Gold plated RCA I/O. Adjustable output levels 80/125/250Hz LP switch  
S/N 100dB  
THD 0.02%  
Base 65x90(x28H)mm



Code
AX100

### ↓ RCA Plugs & Adaptors

#### TERMINAL PANEL

##### ROUND

Easy mount flush solution Drops into a 76mm 3" Hole Gold-Plated screw terminals Accepts large gauge cable and 4mm banana plugs. Each.



Code
J705

#### TERMINAL PANEL

##### SQUARE

Jig-saw hole flush solution Drops into a 72x60mm Hole Gold-Plated screw terminals Accepts large gauge cable and 4mm banana plugs. Each.



Code
J706

#### TERMINAL PANEL

##### BI-TERMINAL

Accepts two sets of inputs Drops into a 75x96mm Hole Gold-Plated screw terminals Accepts large gauge cable and 4mm banana plugs. Each.



Code
J708

## → Speaker Box Ports

### BASS REFLEX PORT 1.3"

Cut to Length Push-fit Flanged mouth  
80mm x 33mmØ

Hole	Code
40mmØ	PORT8033



### BASS REFLEX PORT 1.8"

Cut to Length Push-fit Flanged mouth  
128mm x 45mmØ

Hole	Code
68mmØ	PT760



### BASS REFLEX PORT 2"

Cut to Length Push-fit Flanged mouth  
125mm x 50mmØ

Hole	Code
58mmØ	PORT12550



### BASS REFLEX PORT 2.2"

Cut to size Push-fit Flanged mouth  
180mm x 57mmØ

Hole	Code
84mmØ	PT761

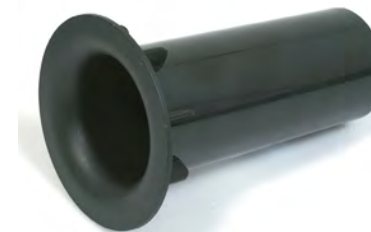

### BASS REFLEX PORT 2½"

Cut to Length Push-fit Flanged mouth  
125mm x 60mmØ

Hole	Code
70mmØ	PORT12560



### BASS REFLEX PORT 4"

Cut to Length Push-fit Flanged mouth  
110mm x 100mmØ

Hole	Code
105mmØ	PORT11010





## ↓ Speaker Grilles

### COMMODORE VE SPEAKER GRILLES

#### PARCEL SHELF REPLACEMENTS

Replacement grilles to suit VE Commodore 06 onwards.

Sold as pairs, cut out template and mounting hardware included.

Code  
VE06G



### LIGHTNING CHROME GRILLE

#### FLASH PROTECTOR

Beautifully finished metal in polished chrome plated Enhances 12" with style Easily mounts over all types of enclosures

Dia. 255mm 305mm  
Size 10" 12"  
Code ACG10 ACG12



### SPEAKER GRILLES

Single piece grille pressed from steel. Rubber grommet outer Strong construction protects speakers outer screw clamps Suit PA, Subs, etc.

Size	Ø	Code
8"	202mm	MG80
10"	254mm	MG100
12"	305mm	MG120
15"	382mm	MG150

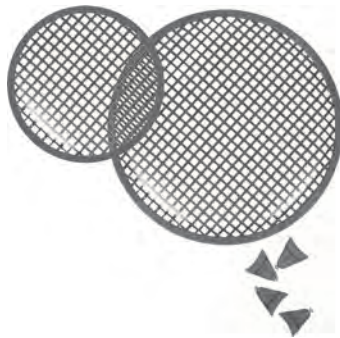

## ↓ Misc

### PLASTIC GRID PLATE

#### ABS SHEETING 0.1M<sup>2</sup>

Textured blank dark grey for custom installations 1/4" thick ABS premium grade Waffle board is already Pre-scored on the back to easily create holes for 3" 4" 5 1/2" 6 1/2" 6x9" or use for panels, etc.

Size Code  
305x305mm ABS9030



### PLASTIC BLANKING PLATE

#### ABS SHEETING 1/4M<sup>2</sup>

Textured blank black for custom installations 1/4" thick ABS premium grade used for covering holes or use for panels, etc.

Size Code  
432x533mm ABS9032



## ↓ Carpets / Cloth / Sound Deadener

### CARPET SPEAKER BOX COVER

"Unbacked" box carpet Unwoven so will not fray Super tough to protect PA Boxes from roadies or Car boot for subs.

#### CHARCOAL 0.75M x 2.0M

Code  
CACH1

#### BLACK 0.75M x 2.0M

Code  
CABK1



### SOUND DEADENER BITUMEN BASED

#### DOOR & FENDER PANEL TAR SHEET

This product is designed to be stuck on the inside of the outer door skins in car installations to deaden resonance and reduce road noise for better stereo! Reduce panel rattles, improve sound for that professional installation. Also, deaden those noisy speaker cabinets with heavy sound absorbing material. Improves box acoustics for subwoofers. 2 x 300mm square sheets supplied.

Code  
MAT302

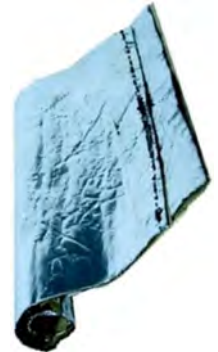

### SOUND DEADENER BARIUM MINERAL BASED

#### FOAM RUBBER ON FELT SHEET STC-27

Felt backed heavy duty foam rubber. 4.5kg/M<sup>2</sup> loaded with Barium mineral has a 4mm sheet of dense foam rubber bounded to the heavy sheet. STC-27 making it ideal to laid under carpets, between door trims and car doors, etc. or inside speaker box cabinet panels. One Sheet size 675 x 330 x 6mm thick.

Code  
MAT675



### SPEAKER GRILLE CLOTH

#### COVERS SPEAKERS, ETC.

High quality, attractive, acoustically transparent grille cloth is ideal for protecting drivers and allowing all of the sound to get through. BLACK. 1500 x 1000mm sheet x1 Black in colour

Code  
SPGC151



## ↓ Tapes

### GASKET TAPE

10mm wide x 5mm thick Sticky one sided tape Black foam compressible conforms to irregular shapes and contours excellent acoustic barrier suits speaker mounting for a good air-tight seal from speaker rim to panel Supplied on 1 metre roll

Code  
GT7100







## ↓ Installation & Accessories

### SOME EXAMPLES

#### MORE ARE AVAILABLE

Too many to list here please select online [www.aerpro.com.au](http://www.aerpro.com.au) then contact us for price & availability

Below are some examples....

[www.aerpro.com.au](http://www.aerpro.com.au)



### HOLDEN COMMODORE VY+

#### DIN MOUNT ADAPTOR

Suits VY 2000+ All Commodores & Monaro. Adapts an after-market Single DIN into dash with space fill pocket Professional. Black.

Code  
FP993528



### FORD AU FALCON

#### UNDER RADIO POCKET

Snap-locks in dash fills vacant space for a professional finish. Available with full fascia or just pocket in dark grey or black.

Type	Colour	Code
Pocket Only	Black	FP9040
Pocket Only	Grey	FP9041
Pocket & Fascia	Black	FP9140
Pocket & Fascia	Grey	FP9141



### FORD 1999-2004

#### DIN MOUNT ADAPTOR

Focus, Cougar, and others. Adapts an after-market Single DIN into dash with space fill pocket Professional. Black

Code  
FP995200



### TOYOTA 2003-2005

#### SINGLE DIN ADAPTOR

Suits Corolla 03'-04' Includes all the extra metal work, etc. for a secure hold of your new after market head unit. Black plastic fascia with pocket space filler

Code  
FP998204



### UNIVERSAL DIN FILLER

UNDER RADIO POCKET  
Snap-locks in dash fills vacant space professional finish.

Colour Code  
BLACK FP9014



### DOUBLE DIN TO SINGLE DIN

#### UNIVERSAL MULTI-KIT

Ford Mazda Nissan Toyota Double-DIN height units used in many car models. Snap-locks in dash to fill in the vacant space left when an after market car head unit is installed Universal adaptors inc.

Code  
FP9000



### DIN & JIN CD POCKETS

#### CD TRAY SPACE FILLER

Holds 6 CDs with push-button trays.

#### GUN METAL GREY

Fits JIN Spacing

Code  
FP9010



### DIN & JIN CUP HOLDERS

#### UNIVERSAL SPACE FILLER

Holds cups or cans plus lined drawer for coins.

#### CARBON FIBRE LOOK

Fits DIN & JIN

Code  
FP9009



### DIN HOUSING

#### UNDER or ABOVE MOUNT

This quality housing allows installation of a DIN or older shaft type head units to be installed where no room was previously provided. Made from UV stabilised black ABS plastic. 90H x 255W x 230D mm

Code  
AP9000





# 18 CAR AUDIO ACCESSORIES

18 CAR AUDIO ACCESSORIES

## ↓ Mobile Phone Holders

### MOBILE PHONE CAR ACCESSORIES

[www.cellink.com.au](http://www.cellink.com.au)

Too many items to list here!

Accessories to suit all Australian mobile phones with a large range of hands-free kits for the car



### WINDSHIELD MOUNT CRADLE - PHONE SPECIFIC

#### CHOOSE TO SUIT YOUR PHONE

Available in vertical and horizontal clips to suit iPhones, Nokias, and other popular models. Windscreen suction cup type. May come with goose neck or adjustable armature.



See [www.cellink.com.au](http://www.cellink.com.au) for your model phone.

### UNIVERSAL MOBILE PHONE HOLDER

#### ADJUSTABLE CRADLE

Compatible with all our brackets on these pages Padded adjustable jaws spring grip firm hold 40-47mm suits modern sized mobiles. Black. Requires screws

SPRING HOLD →



Code  
CRA20

### UNIVERSAL MOBILE PHONE HOLDER

#### VENT MOUNT

Easily attaches to the dash air vents to hold your mobile phone Padded adjustable jaws push-grip for firm hold 35-60mm suits most sized mobiles. Black.



VENT CLIPS

Code  
CRA40

### WINDSCREEN MOUNT - SLATE & TABLET PC

#### UNIVERSAL LOCKING JAWS

Adjustable claws hold various tablets, slates, iPads, etc. Felt & rubber grips. Position locking. 90mm suction cup.



Size Code  
Max=300mm min=200mm CRA57

## ↓ Mounting Brackets

### CLAM SHELL BRACKET

#### 180° TILT

Metal construction. Thumb-screw locking. Black enamel paint. Includes screws. 60x55x20mm

Code  
CSM10



### "Z" MOUNTING BRACKET

#### 270° DOUBLE TILT

Fully adjustable dual elbow type stand-off bracket Metal construction screw driver lock 65x50x30mm → 90mm

Code  
CSM81



### UNI-JOINT MOUNTING BRACKET

#### ADHESIVE BACKED

Dual axis 180° x 360° Points any direction Position lock screws 45x45mm x 60mm 3M® for maximum grip

Code  
MNT50



### TILT/SWIVEL MOUNTING RIG

#### MULTI-BEND ARM

Heavy duty metal All positions 3x 360 rotations 2x 180 elbows 145mm extension Common 45x55mm base

Code  
MNT32



### GOOSE NECK

#### 330mm FLEX SPRING

With wire through 15mm diameter 45mm Round base to common square 45x55mm base 40x30mm holes. Black metal.

Code  
MPB-GN



## ↓ Bluetooth

### BLUETOOTH CAR KITS

CELLINK DRIVE-SAFE  
NEW! Range available.  
[www.cellink.com.au](http://www.cellink.com.au)







## ↓ Mobile Phone Holders

### iPOD iPhone TO FM TRANSMITTER CRADLE

**iPhone iPod Charger**  
iPhone FM Hands-Free  
Car kit and FM Audio  
Transmitter With Cigarette  
Mount Holder and Charger.

Code  
CRA9003



### UNIVERSAL CRADLE & PATCH CABLE

#### MOBILE ANTENNA PATCH

Padded Phone holder adjustable fingers. Inbuilt coupler with FME Male fly lead out for external antenna. Requires mount option & antenna. Suit Apple iPhone 3G/3Gs Nokia, Blackberry, Motorola, Samsung, LG, HTC, Sony, etc. Multi-Band GSM, Next-G, 3G.

Code CAL9002



### ACCESSORIES SOCKET CRADLE WITH USB

Cigarette Socket Adaptor / USB with Phone Holder. 360 degree rotation for vertical or horizontal mode. Adjustable to hold for all types of mobile phones, smart phones, PDA, GPS & MP3/MP4 devices. Turn this collar section to expand or contract the Cigarette lighter plug for 20 or 22mm sockets.

Code  
APH350



### CAL9002 MOUNTING OPTION DASH BRACKET

Stick-on-dash solution Ball-in-socket angle adjust with screw lock Premium 3M adhesive Suits CAL9002 cradle (clips on back of)

Code MNT72



### DUAL ACCESSORIES SOCKET CRADLE

Twin Cigarette Socket Adaptor with Phone Holder. 360 degree rotation for vertical or horizontal mode. Adjustable to hold for all types of mobile phones, smart phones, PDA, GPS & MP3/MP4 devices. Turn this collar section to expand or contract the Cigarette lighter plug for 20 or 22mm sockets.

Code  
APH300



### CAL9002 MOUNTING OPTION SUCTION CUP & GOOSE NECK

65mmØ heavy-duty suction cup 270mm stand-off with twist and bendable goose-neck for precise viewing adjustment Suits CAL9002 cradle (clips on back of)

Code MNT76



### ACCESSORIES SOCKET CRADLE WITH USB

Single Socket Adaptor & Single USB Port with Phone Holder. Powers one 12V and one 5V accessory at the same time. 180 degree rotating function. Turn this collar section to expand or contract the Cigarette lighter plug for 20 or 22mm sockets.

Code  
APH250



### CAL9002 MOUNTING OPTION WINDSCREEN SUCTION CUP

65mmØ heavy-duty suction cup 110mm stand-off 30° angled with Ball-in-socket angle adjustment and screw lock Suits CAL9002 cradle (clips on back of)

Code MNT78



### DUAL ACCESSORIES SOCKET CRADLE

Twin Cigarette Socket Adaptor with Phone Holder. Powers two 12V accessories at the same time. 180 degree rotating function. Turn this collar section to expand or contract the Cigarette lighter plug for 20 or 22mm sockets.

Code  
APH200



### CAL9002 MOUNTING OPTION AIR VENT BRACKET

Clips on air-con vents Ball-in-socket angle adjust with screw lock Suits CAL9002 cradle (clips on back of)

Code MNT70





## ↓ Mounting Brackets

### CAR MOUNTING BRACKETS

#### MOBILE PHONE PDA SAT-NAV

Non damaging install solution enables mounting accessories using existing dash screws. Sturdy Black enamel painted steel brackets for mounting mobile phone cradles, etc. Development notes listed but also suitable or adaptable for other cars and applications.



#### MOBILE PHONE MOUNTING PLATE

Adapt brackets Mount solutions or behind support for bolts, etc.

Size Code  
55x50mm MPB-BP1



#### MOBILE PHONE MOUNTING PLATE

Use to raise the height of your phone bracket or Adapt brackets & Mount solutions or behind support for bolts, etc.

Size Code  
88x42mm MPB-BP2



#### MOBILE PHONE MOUNTING BRACKET

L Shaped bracket Base 36x50mm, Phone 41x50mm

Code  
MPB1400



#### MOBILE PHONE MOUNTING BRACKET

L Shaped bracket Base 70x80mm, Phone 39x80mm

Code  
PB28



#### MOBILE PHONE MOUNTING BRACKET

L Shaped bracket Base 54x70mm, Phone 68x70mm

Code  
MPB1777



#### MOBILE PHONE MOUNTING BRACKET

L Shaped bracket MG & Mercedes, etc. Base 243x75mm, Phone 60x75mm

Code  
MPB1222



#### MOBILE PHONE MOUNTING BRACKET

L Shaped bracket Base 248x80mm, Phone 39x80mm

Code  
PB27



#### MOBILE PHONE MOUNTING BRACKET

DIN size bracket Elbow stand-off 20mm, Base 190x60mm, Phone 39x60mm

Code  
PB65



#### MOBILE PHONE MOUNTING BRACKET

L Shaped bracket Suits Lexus, etc. Base 240x50mm, Phone 42x50mm

Code  
MPB1892



#### MOBILE PHONE MOUNTING BRACKET

45 Base Plate Forward fascia Suit Statesman Kingswood, etc. Stand-Off 25mm, Base 18x50mm, Phone 50x50mm

Code  
MPB1450



#### MOBILE PHONE MOUNTING BRACKET

R/A Pocket mount Suit Toyota Camry, etc. Base 32x50mm, Phone 42x50mm

Code  
PB74





## MOBILE PHONE MOUNTING BRACKET

L Shaped bracket \*Smaller base Suits Magnas and pocket mounts, etc. Base 70x\*34mm, Phone 52x50mm

Code  
PB70



## AUDI

Hook & Hold No screws Suits Audi Base 9x52mm, Reach 32mm, Phone 72x52mm

Code  
PB86



## MOBILE PHONE MOUNTING BRACKET PHILIPS

Suits a classic 80's early model deluxe Philips car stereo L Shaped bracket with a bit cut-out\*. Base 37x\*80mm, Phone 62x80mm

Code  
MPB1810



## BMW EARLY

U Bracket 3 5 7 Series and Z3, etc. Base 49x65mm, Reach 38mm, Phone 80x65mm

Code  
PB73



## MOBILE PHONE MOUNTING BRACKET

L Shaped bracket Tapered reach of 68mm from screw for mounting in dash gaps, etc. Reach 80mm, Phone 44x54mm

Code  
PB80



## COMMODORE VP-VS

Tilt bracket for Commodore Ashtray area. \*Phone base. Base 24x80mm, Reach 85mm 110, Phone 42x50/80mm\*

Phone Base	Code
80mm	MPB1319
50mm	PB69



## MOBILE PHONE MOUNTING BRACKET

General purpose mounting brackets

Code  
MPB1405



## COMMODORE VT-VX

Double bend L Custom fits Commodore Radio area Base 54x44mm, Reach 14 & 5mm, Phone 55x50mm

Code  
PB66



## MOBILE PHONE MOUNTING BRACKET

General purpose mounting brackets

Code  
MPB1404



## COMMODORE VY-VZ

Tri-bend L Custom fits Commodore Radio area Base 17x62mm, Reach 25mm, Phone 44x50mm

Code  
PB68



## ASTRA

Custom suits Holden Astra Base 27x38mm, Reach 30mm, Phone 50x50mm

Code  
MPB1615



## COMMODORE VY-VZ

Custom fits Commodore Above-right Vent area Does not interfere with drink holders Reach 75mm, Phone 44x54mm

Code  
PB67





# 18 CAR AUDIO ACCESSORIES

18 CAR AUDIO ACCESSORIES

## FALCON AU

Double bend L Custom suits Ford Falcon AU Car radio area Base 52x44mm, Reach 16mm, Phone 52x48mm

Code  
PB72



## FORD RANGER/MAZDA BRAVO

Code  
MPB1401



## FALCON AU-II

Double bend L Custom suits Ford Falcon AU Car radio area Base 40x38mm, Reach 28mm, Phone 56x50mm

Code  
PB79



## LAND CRUISER 200 SERIES

Code  
MPB1402



## FALCON BA

Custom suits Ford Falcon BA Centre console LEFT HAND Reach 62mm, Phone 42x54mm

Code  
PB75



## MITSUBISHI 380

Customised bracket Suits Magna using existing bolts and fixtures. Base 40x17mm, Reach 40mm, Phone 40x45mm

Code  
PB77



## FALCON BA

Custom suits Ford Falcon BA Centre console RIGHT HAND Reach 48mm, Phone 50x50mm

Code  
MPB1005



## MITSUBISHI PAJERO

Customised bracket Suits Pajero using existing bolts and fixtures. Phone 40x45mm

Code  
PB87



## FALCON EF-EL

L Shaped bracket Suits EF-EL Falcon and others. Base 72x50mm, Phone 43x50mm

Code  
PB71



## SUBARU

Angle bracket Airvent area 2 tag base Base 16x50mm, Reach 25mm, Phone 45x50mm

Code  
MPB1555



## FORD G SERIES

Code  
MPB1410



## TOYOTA AVALON

Double tilt Custom suits Toyota Avalon Base 24x54mm, Reach 48mm, Phone 44x54mm

Code  
MPB1333





## TOYOTA CAMRY

120 L Shaped bracket  
Tapered base for dash Suit  
Toyota Camry, etc. Base  
68x35mm, Phone 52x50mm

Phone Base	Code
25mm	MPB1500
15mm	MPB1999
15mm	PB78



## TOYOTA CAMRY 2007

Code  
MPB1409



## TOYOTA HILUX

Custom suits Toyota Hilux  
Base 67x25mm, Reach  
42mm, Phone 50x55mm

Code  
PB76



## TOYOTA UTE

Suit, Prado, Hiace, Kluger,  
Toyota V8 utes etc.,

Code  
MPB1403



## VECTRA

Double bend L Custom  
suits Holden Vectra Base  
34x44mm, Reach 18mm,  
Phone 55x50mm

Code  
MPB1888



## ABS PLASTIC SHEETS

### 1ft Square Sheets x4

3mm Thick Black ABS with grain pattern.  
Ideal for custom car interior work, etc.  
300x300x3mm. Buy one to receive 4 pcs.

Code  
ABS4PK



## ↓ Installation Misc

### COMMODORE VE CB ANTENNA MOUNT

VE Holder Front Left Bonnet

Code  
MPB1406



### COMMODORE VE CB ANTENNA MOUNT

VE Holder Front Right Bonnet

Code  
MPB1407



### COMMODORE VE CB ANTENNA MOUNT

VE Holden Boot

Code  
MPB1408



## MOUNTING SELF-TAPPERS

### BOX OF 100x SCREWS

Pan-head Needle Point Black  
High-density particle board  
Metals & some woods, etc.

Size	Code
3.9x13mm	STB3913
3.9x25mm	STB3925
4.2x32mm	STB4232



## NUT & BOLT KITS

### BAGS OF NUT/BOLT/WASHERS

Pan head Posi Bolt x50 Nut x50 &  
Washer x50 Metric threaded sets

#### M3 [3mm Hole]

Code  
M350KB

#### M4 [4mm Hole]

Code  
M450KB



## MORE...

### SEE SECTION 14...

Comprehensive range of hardware for car installations including more screws, drill bits, tools, etc.





# 18 CAR AUDIO ACCESSORIES

## ↓ LCD Mounting Brackets

### HEADREST MOUNTING BRACKET FOR LCD

Monitor Headrest Mounting Bracket Holds TFT TV/Monitor to Headrest. Fully adjustable for mounting any LCD screen for rear seat viewing. Made from UV Stabilised Plastic. 195mm(H) x 235mm(W) x 60mm(D). Ball/socket angle adjustment

Code AVHRMB



### HEADREST MOUNTING BRACKET FOR LCD

Easy installation, simply attaches to your front seat's headrest. Variable adjustment positions for multiple viewing angles. Suits locating LCD monitors directly behind a seats headrest Made from quality components Rod is durable steel. Fully adjustable. Extension pieces.

Code AVPT9



### HEADREST MOUNTING BRACKET FOR LCD

Easy installation, simply attaches to your front seat's headrest. Variable adjustment positions for multiple viewing angles. Suits centre locating monitors To the Left or Right of a front seat headrest. Made from quality components Rod is durable steel. Fully adjustable ball-socket.

Code AVPT2

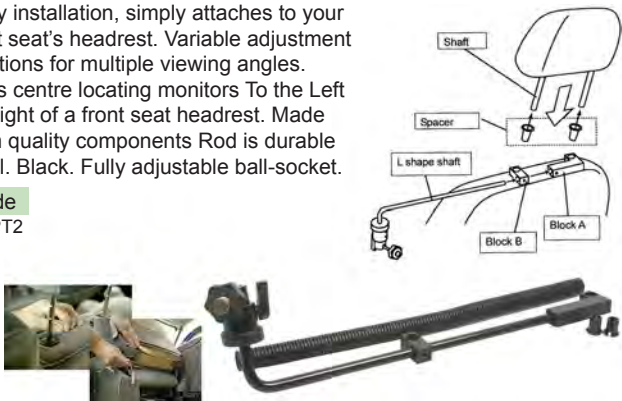

### DELUXE HEADREST BRACKET

#### PREMIUM IN LOOKS & FUNCTION

Monitor Deluxe Headrest Side Mounting Bracket for centrally locating an LCD monitor between front seats for back seat viewing Simply attaches to your headrest. Variable adjustment positions for multiple viewing angles with full tilt/pan capabilities. Black. Can be removed when not required. Made from quality components.

Code AVPT14



### DIN POCKET WEDGE MOUNTING BRACKET

Inserts into dash pockets Approximately DIN in size Expand the screw to lock Manual up-down tilt mechanism for variable viewing angles. Made from quality components and durable steel. Black.

Code AVPT6



### DIN WIDE LCD MOUNTING BRACKET

Simple DIN mount attachment on each side of A DIN radio. Manual up-down tilt mechanism for variable viewing angles. Made from quality components and durable steel. Black.

Code AVPT11

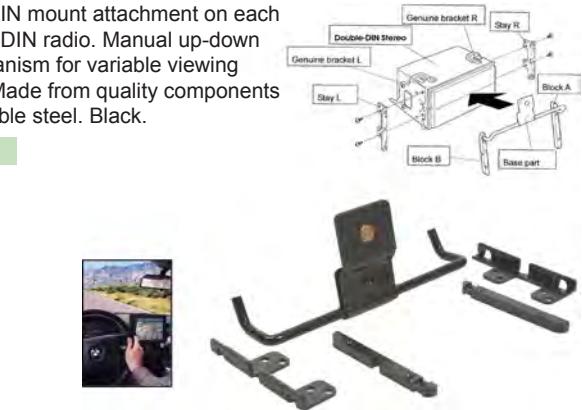

### DASH MOUNT LCD BRACKET

Monitor Dashboard Mounting Easy installation solution simple stick-on dash attachment. Manual up-down and side tilt mechanism for viewing angles. Rotates, stand-off, +180° tilt. Also excellent Sat-Nav holder Made from quality components and durable steel. Black.

Code AVPT12



### DASH MOUNT LCD BRACKET

Monitor Dashboard Mounting Easy installation solution simple stick-on dash attachment. Tilt up-down for viewing angles. Flexible metal fingers for good stick to non-flat dashboards Made from quality components

Code STAND589





↓ **Audio Visual Accessories**

**AUDIO INTERCONNECT**

**HIGH GRADE OFC**

Pure %99.99 copper with double shielding, weatherproof extra-tough jacket, gold plated contacts and trigger wire.

**1 SOCKET - 2 PLUGS**

Length	Code
0.1M	OFC622

**1 PLUG - 2 SOCKETS**

Length	Code
0.1M	OFC625

**2 PLUGS - 2 PLUGS**

Length	Code
0.1M	OFC606
0.8M	OFC607
1.5M	OFC608
3.0M	OFC612
5.0M	OFC614
8.0M	OFC615
15M	OFC616



**A/V CONNECTION LEADS**

**3.5mm → RCAx2**

Stereo headphone to Stereo RCA or Multi-media A/V

Length	Code
1.2M	AL656

**ABOVE SOCKET**

3.5mm Socket to RCAx2

Length	Code
0.1M	AL638

**VIDEO RCA**

75Ω Coax RCA

Length	Code
1.5M	VC212



**MORE SECTION EIGHT**

Many More A/V Interconnects See Section 8...

**ARCADE GAME CONNECT**

**UNIVERSAL**

PSX PS1 PS2 N64 Xbox

Length	Code
2.0M	AUB301

**X-BOX & 360**

3x RCA + S-Video

Type	Length	Code
Black	2.0M	XB0103
Grey	2.0M	XB360-01

www.gamemaster.com.au



**POWER ADAPTORS**

**REGULATE CARS VOLTAGE**

Accessories plug type regulated DC→DC power Outputs to DC Plugs Kit included

Current	Code
1AMP	SDR0121A

**240VAC HOME POWER**

LCD Screens do not come with 240Vac power options You will require 12Vdc Most LCD are hard wired. Some accept 2.5mm DC plugs (MON318GL & MON809GL)

Current	Code
1500mA	SMP1500-12-21P



→ **Reversing Sensors / Cameras**

**SUPER-SMALL OUTDOOR COLOUR CMOS**

**WEATHER PROOF IP67**

45° Mounting bracket Body rotates to align 130° Wide Angle FOV Very rugged for use on vehicles, etc. Very compact 19x18mmØ Includes 8 metre cable & extendable (S-Video type) Requires 12Vdc 40mA NTSC Colour (for cars). Hard wired power leads RCA Plug Video output. 2.0 Lux 6.35mm ¼" CMOS Suit car reverse, etc.

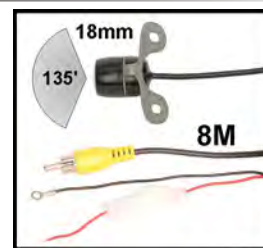

Code
CM103



**HOLE-MOUNT COLOUR CMOS**

**WEATHER PROOF**

Metal barrel. Flush mounting As used with Reversing kits. 25mm Hole mount 45mm deep +lead 1/3" CMOS Colour 420 TVL PAL/NTSC 628x582 pixels FOV 92° WideAngle 2.0 Lux 3.6mm 12Vdc (2.1mm) RCA Video out



**WITH ANGLE ADJUSTABLE WEATHER PROOF SEAL**

System	Code
NTSC	CM101N
PAL	CM101P

**25mm Hole Mount**

**HOLE-MOUNT COLOUR CMOS IR**

**WITH IR ILLUMINATION**

Weather proof Flush mounting As used with car Reversing kits. Metal barrel 28mm Hole mount 45mm deep +lead 1/3" CMOS Colour 420 TVL PAL/NTSC 628x582 pixels FOV 110° WideAngle 2.0 Lux (0 Lux) 12Vdc (2.1mm)



**IR ILLUMINATED 0 LUX**

**WITH ANGLE ADJUSTABLE WEATHER PROOF SEAL**

System	Code
NTSC	CE100N
PAL	CE100P

**28mm Hole Mount**

**HOLE-MOUNT COLOUR CCD**

**WITH IR ILLUMINATION**

Metal barrel. Flush mounting. As used with Reversing kits. 28mm Hole mount 75mm deep lead. 1/3" CCD Colour 420 TVL PAL/NTSC 628x582 pixels FOV 110° WideAngle 0 Lux IR Illuminated. 12Vdc (2.1mm) RCA Video out. Includes Drill bit and connection cables. FOV 110°



**WITH ANGLE ADJUSTABLE WEATHER PROOF SEAL**

**CCD COLOUR**

**28mm Hole Mount**



# 18 CAR AUDIO ACCESSORIES

18 CAR AUDIO ACCESSORIES

## → DVR

### 2.5" HD PORTABLE DVR

#### ROAD SAFETY RECORDER 1.3M CAMERA & RECORDER

2.5" LCD Screen with a high definition video recording camera and 6 LED night illumination. Cycled recording so will hold the last, say 15min of recording. Support SD card up to 32GB (not included). Support Loop Recording & Motion Detection function. In-built microphone for sound recording. Li-ion rechargeable battery and 12V car charger. Mini USB 2.0 interface for file transfer. 120° viewing angle. 107x62.x33mm plus windscreen stand.

2.5" TFT LCD 270 degree rotation.  
 1/4 color CMOS HD 1.3M Image Sensor.  
 Recording resolution: 1280x960/720x480/640x480 pixels.  
 AVI video format for file storage  
 Automatic recording after power up.  
 Repeat storage by section- 2/5/15 minutes.  
 Supports SD card (From 2GB to 32GB ).  
 Power source: Li-ion rechargeable battery.

Code  
 DVR100

Requires SD Card memory for DVR



## → LCD Monitors

### 7" TFT-LCD COLOUR MONITOR FLUSH-MOUNT

#### 18cm 16:9 WIDESCREEN WITH INBUILT SPEAKER SYSTEM

Modern styling and design for flush mount into headrest, etc. Includes optional dash free-standing assembly. Built-in speaker. Dual Video RCA inputs. NTSC/PAL Auto. Low profile screen with clear & sharp TFT technology. Composite video input. Front panel controls. Two rear Video-In. Trigger line for reversing camera. Free standing option with included dash stand or connection to optional headrest stands, etc. Flush mount kit Insert into walls, headrests, etc. Remove bracket for stand alone option. Includes remote control. Inbuilt speaker. Super slim 184x126x25mm. Headrest frame 200x143x29mm.

Code  
 HR701NPS



**INBUILT SPEAKERS  
 HEAD REST MOUNTING OR STAND-ALONE MOUNTING**

### 7" TFT-LCD COLOUR MONITOR FLUSH-MOUNT

#### 18cm 16:9 WIDESCREEN WITH OPTIONAL IR OUTPUT

Modern styling and design for flush mount into headrest, etc. Includes optional dash free-standing assembly, or 1/4" socket. Dual Video RCA inputs. Remote control. NTSC/PAL Auto. Super slim 184x126x25mm. Headrest frame 200x143x29mm Stereo audio IR transmission model for headphones (See optional Cordless HP701 headphones below) No Inbuilt-Speaker option on this model Requires cordless headphones (Not Included).

Code  
 HR701NP

#### OPTIONAL IR HEADPHONES

Add-On Cordless listening for HR701NP Above.

Code  
 HP701



**OPTIONAL CORDLESS HEADPHONES (EACH)**



**HEAD REST MOUNTING  
 OR  
 STAND-ALONE MOUNTING**





## ↓ LCD Monitors

### 7" TFT-LCD PC & TV TOUCH-SCREEN

#### WIDE-SCREEN 16:9 PC/TV/TUNER

High Resolution 800x480 pixels PC Monitor and Video Monitor & TV Tuner in one unit. USB Connection for touch screen control simulates a mouse with windows software. Excellent solution for a no keyboard PC Like in Cars, RVs, Trucks with GPS, etc. Inputs: 3x RCA CVBS and 1x HD15 PC Inbuilt speaker. Compact 188x125x33mm For use with 12Vdc includes car adaptor. Includes desk/dash stand. Remote control.

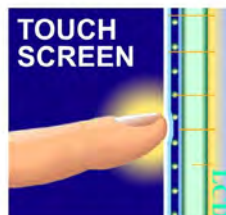

Code  
MON618TV

#### WITHOUT TV-TUNER OPTION

Code  
MON619GL



### 9" CEILING UNIT MONITOR FLIP-DOWN & ROTATE

#### 16:9 WIDE SCREEN TFT LCD NTSC/PAL

Ultra low profile roof monitor mounts in place of ceiling light. 9 inch high resolution wide screen 16:9 LCD-TFT panel. Inbuilt dome light with on off switch. Inbuilt clock. Drop-down and 180 degrees swivel screen Returns to low-profile close with secure locking button. Dual A/V inputs from in-dash player, game console, etc. Includes remote control for screen picture adjustments. 245x245x30mm. Black.



Code  
MON-920

### 3.5" LCD FLIP-DOWN MONITOR

#### COMPACT 90mm 4:3 TFT-LCD CEILING UNIT

Suit compact installations of reversing cameras or other monitor duties requiring a roof mounting screen that folds away. Locks in the UP position for low-profile Rotates on axis for left or right Auto-Off when closed. Black plastic. 2x RCA video inputs 480x234 pixels 2nd input triggered by "Reverse" wire. Side control buttons for main power, Dimmer switch and Norm/Mirror view. Compact 100x95x25mm



**PUSH-CLOSE  
AUTO-ON/OFF  
or  
REVERSE-GEAR  
SWITCHED**



Code  
MON090F



## → Reversing Sensors / Cameras

### 4.3" REAR VIEW MIRROR MONITOR

#### UNIVERSAL CLIP-ON STYLE

Special anti-glare screen for eye sight protection, in position of the original rearview mirror. Touch screen button control. 2xRCA video input 16:9 480x272 pixels 12Vdc 275x77x23mm 295g. Dual video input to connect VCD/DVD/TV/GPS and rear view camera. Automatically connect to rear view system when reversing, ensure parking safely. Includes extra long cabling and butterfly camera. All metal Weather proof 1/3 sharp CCD colour anti fog glass super mini butterfly camera with 420TVL, Wide angle 170° minimum illumination 0.1lux. Wiring Kit includes 5.5M camera video cable, 1M camera power cable and 2M monitor cable.



Code  
RV431



### 5.5" REVERSING MIRROR LCD MONITOR

#### VELCRO STRAPS TO EXISTING MIRROR

Deluxe kit with dual video input monitor 5.5" colour Toshiba LCD TFT Display screen. Extra-High brightness back lit for day viewing. Straps directly onto your existing rear-view mirror. Adjust picture and inputs via the Side Buttons or the included IR remote control. On-Screen-Display. Suits RCA Video in: VCD/DVD/TV/GPS/MPEG4/NTSC/PAL 2 inputs. 16:9 aspect (WideScreen) 800x480px RGB. 12Vdc 5W 280x95x25mm Strap-On Anti-Glare Blue Mirror. Auto switch lead for rear-view system with connection to reversing light.



Code  
KVC9

#### MIRROR MONITOR ONLY

Code  
KVC8



VELCRO STRAP TO MIRROR

WIRING KIT



CMOS Colour CAMERA

### 4.3" REVERSING CAMERA SYSTEM

#### HARD WIRED OR WIRELESS

Replace your mirror with an LCD Screen! Rear-view optical mirror with built-in 3.6" LCD. Special anti-glare screen for best rear view. Wireless colour video transmission module. 100° horizontal and 60° vertical viewing angle high definition CMOS colour camera. Monitor & Camera Kit includes camera mount, 1.2M camera power harness, 2M monitor power & video harness, 2M Wireless Transmitter harness, 5M Video extension cable. Monitor 297x80x18mm 275g.

Code  
ARV43M



Mounting bracket sits behind the number plate and it is not visible.



### 7" REVERSING MIRROR LCD MONITOR

#### TOUCH BUTTON FUNCTION

Replace your mirror with an LCD Screen! Rear-view optical mirror with built-in Compact 7" colour LCD TFT Display screen. Replaces your existing rear-view mirror. Adjust picture via the remote control On-Screen-Display. 2 x RCA Video Input 480x234 pixels 12Vdc 248x110x43mm 400g. Includes extra long cabling and butterfly camera. All metal Weather proof 1/3 sharp CCD colour anti fog glass super mini butterfly camera with 420TVL, Wide angle 170° minimum illumination 0.1lux. Wiring Kit includes 6M camera video cable, 1M camera power cable and 2.4M monitor cable.

AV1 connects VCD/DVD signal input. AV2 connects camera signal input. AV2 will be switched automatically from VCD/DVD when reversing gear is used and return back after parking.

Code  
RV751





## EASY ECONOMICAL REVERSING SENSOR KITS

### DETECT OBSTACLES BEHIND THE CAR

With Distance Shown In Metres ! Have no fear when parking with this all-weather parking sensor. Measures and displays the distance of objects up to 1.5 metres away and alerts the driver of approaching obstacles. A Four Sensor Deluxe Version indicates the direction of the nearest obstacle.



### SAFE & AFFORDABLE TECHNOLOGY

A numeric digital LED display shows the distance in metres and also emits an audible buzzer that increases in tempo the closer you get to the obstacle.

### Makes reverse parking safe and simple!

It works horizontally and vertically with ultra-sonics and micro-computers. Very compact in design for easy and attractive non-obtrusive installation.



## TWO-SENSOR REVERSING KITS

Attractive, Compact 60x15x12mm Coloured LED Distance Display. Attach to rear view mirror or dash. Clever Audible Distance Alerting. Simply connects to your reverse lamp so will Automatically activate when vehicle is placed in reverse mode. Measures distance from 1.5M to 0.3M Complete with instructions. 12Vdc. Removes agitation and apprehension. Increases safety and confidence.



### INSTALLATION OPTIONS:

Available in two installation versions: Stick-on sensors for easy installation or Professional flush mount sensors. Sensor locating instructions included. Both kits include all required hardware. 1 x Digital display with 4.5M cord 2 x Sensors with 2.2 metre cord ea. 1 x DC power cord to reverse lamp. 1 x Control box 200x260x40mm 1 x Drill bit (RS02B only)



### STICK-ON SENSORS X2

Complete kit with 3M Stick adhesive weather proof ultra-sonic sensors. Makes installation for the novice very simple and intuitive. Black. Stop reverse accidents today! Incredibly economical safety. Upgrades any car or van, etc.



### DUAL SENSOR KIT

Code  
RS02S

### BUILT-IN SENSORS X2

Complete kit with Flush mounting weather proof ultra-sonic sensors. Even includes the required drill-bit! Makes for an almost invisible and very professional installation. Audible and visual reversing assistance, economically.



### DUAL SENSOR KIT

Code  
RS02B

## FOUR-SENSOR REVERSING KITS

Deluxe version. Wide beam safety. Similar technology to that used in today's exotic European cars. With a four sensor array across the rear bumper, a more accurate surround distancing is displayed. Obstacles are indicated with an easy to read Left/Right bargraph and distance metre head unit that can be easily dash mounted. Also suitable for larger vehicles.



### INSTALLATION OPTIONS:

Available in two installation versions: Stick-on sensors for easy installation or Professional flush mount sensors. Sensor locating instructions included. Both kits include all required hardware. 1 x Digital bargraph & distance display 4 x Sensors with 2.2 metre cord ea. 1 x DC power cord to reverse lamp. 1 x Control box 200x260



### DELUXE STICK-ON SENSORS X4

Complete kit with 3M Stick adhesive weather proof ultra-sonic sensors. A larger more informative display. Suit small to very large vehicles. Deluxe display unit with directional bargraph display and distance metre. Very simple and intuitive. Black.



### QUAD SENSOR KIT

Code  
RS04S

### DELUXE BUILT-IN SENSORS X4

Complete kit with Flush mounting weather proof ultra-sonic sensors. Even includes the required drill-bit! Makes for an almost invisible and very professional installation. Remove your blind-spot and park with confidence! Black sensors.



### QUAD SENSOR KIT

Code  
RS04B



## → Lighting

### NEON LIGHT STICKS 6"

#### SUPER-THIN NEON RODS

Only 5mm Diam. Silver caps.

15cm (6") 5mmØ

Colour Code

Blue NE75B

Scarlet NE75S

Green NE75G

30cm (2x 6") KIT

Includes sound modulator

Colour Code

Blue NE76DB

Green NE76DG

Scarlet NE76DS



### 9" SLIM LINE NEON

235mm Long 5mmØ Thin

"Brightness index" rating: 6

Overall length 305mm

12V Input. Current: 0.28A.

On/Off switch located on

cigarette lighter plug.

Cable length: 2 Metres

Colour Code

Blue SLN9BL

Green SLN9GR

Pink SLN9PK

Red SLN9RD

Violet SLN9VL

Yellow SLN9YL

White SLN9WH

Black SLN9BK



### NEON LIGHT STICKS 8" & 12"

#### 12V NEON RODS

1.5M Accessories Plug.

22cm (9")

Colour Code

Blue SLN9BL

Pink LU8PK

Red LU8RD

30cm (12")

Colour Code

Blue LU12B

Pink LU12PK



### 12" SLIM LINE NEON

295mm Long 5mmØ Thin

"Brightness index" rating: 6

Overall length 305mm

12V Input. Current: 0.33A.

On/Off switch located on

cigarette lighter plug.

Cable length: 2 Metres

Colour Code

Blue SLN12BL

Green SLN12GR

Pink SLN12PK

Red SLN12RD

Yellow SLN12YL

White SLN12WH

Black SLN12BK



### NEON LIGHT STICKS 27"

#### EXTRA LONG 2 FOOT

Water Resistant Silver end

caps Hard wired. 12Vdc.

63cm overall length.

50cm (27")

Colour Code

Blue NE24B

Green NE24G

Purple NE24P

Scarlet NE24S

White NE24W



### 7.4" COLD CATHODE

#### 188mm SUPER-BRIGHT NEON

A new technology that's up

to 5 times brighter than neon

for less power usage.

Flicker free, instant on,

Longer life, 12Vdc 280mA,

Super bright neons.

Colour Code

Blue CCN8B

Red CCN8R



### BLACK LIGHT NEON

#### 9" & 12" ULTRA-VIOLET

Near invisible brightness

"Brightness index" rating: 6

Overall length 305mm

12V Input Current: 0.28A

1A Fuse located inside

cigarette lighter plug

On/Off switch located on

cigarette lighter plug

Cable length: 2 Metres

Size Code

235mm SLN9BK

295mm SLN12BK



### 11.3" COLD CATHODE

#### 287mm SUPER-BRIGHT NEON

"Brightness Index" rating: 9

12V Input Current: 0.33A

On/Off switch located on

cigarette lighter plug

Cable length 2M. Overall

length 338mm

Colour Code

Blue CCN12B

Red CCN12R





## ↓ Light Sticks

### LED LIGHT STRIPS DELUXE

#### IN/UNDER-CAR DECORATIONS

High brightness LED strips 2½x brighter than Neons with less power. 12Vdc. Clip together extendable

**240cm (2x 48")**

Colour	Code
Blue	EL482B

**120cm (2x 24")**

Colour	Code
Blue	EL242B



### LED MULTI-COLOUR STRIPS

#### SOUND DECORATIONS

Easy to use controller Multi-mode LED chaser Million colour sequencer Beats to the music mode Supplied as a kit with 2x Multi-colour sticks Push-button controller 12Vdc with fuse

**45cm (2x 9")**

Code
EL225MD



### LED LIGHT STRIPS

#### IN/UNDER-CAR DECORATIONS

8/11 Super bright LEDs in strips 12Vdc Accessories plug switched

**20cm (8")**

Colour	Code
Blue	EL200B
Red	EL200R
Green	EL200G
White	EL200W

**30cm (12")**

Colour	Code
Blue	EL300B
Red	EL300R
Green	EL300G
White	EL300W



### LED MULTI-COLOUR STRIPS

#### UNDER CAR KIT

2x 36" LED Strips 900mm  
2x 48" LED Strips 1200mm  
Water resistant Under Car Kit  
16.4 Million colour sequences  
378 Wide-angle ultra bright LEDs  
12 Distinct flash patterns  
Full function wireless remote control  
Set to individual colours  
Beats to music  
Packed in full colour box

Code
EL4836M



### BUBBLE LED LIGHT STRIPS

#### IN-CAR SMOOTH MOOD LIGHTING

Soft light spectacle. 12Vdc LED.

**16cm (6")**

Colour	Code
Blue	EL76B
Red	EL76R

**32cm (2x 6") KIT**

Includes sound modulator

Colour	Code
Blue	EL76DB
Red	EL76DR
Green	EL76DG



## ↓ Flexible Light Strips

### 12" LED LIGHT STRIPS FLEXIBLE

Strip of LEDs now with new Super-Flex body. Can be cut to custom length with side cutters. Water resistant, 12Vdc. 2mm thickness, 8mm width, Packed in hang sell, full colour blister.

Colour	Code
Blue	ELF12B
Green	ELF12G
Red	ELF12R
White	ELF12W



### GRILLE LED LIGHT STRIPS

#### CAR LIGHT SEQUENCER

Super-Bright Z Hybrid LEDs 10 light sequence patterns including night-rider type Plus sound beat detection for all LEDs music dance 8 Level speed adjustment Water resistant protected Suit grille, etc. 12Vdc.

**40cm (16")**

Colour	Code
Blue	EL9NB



### 24" LED LIGHT STRIPS FLEXIBLE

#### WATER-RESISTANT 610mm

Strip of LEDs now with new Super-Flex body. Can be cut to custom length with side cutters. Water resistant, 2mm thickness, 8mm width, 12Vdc. Packed in hang sell, full colour blister.

Colour	Code
Blue	ELF24B
White	ELF24W





## ↓ Other Lighting

### 12V WARNING LAMP

#### AMBER EMERGENCY STROBE

Excellent solution for safety and emergencies. 12Vdc accessories plug. Curly cord 1Mg2M long. Felt padded magnetic base for bonnet or hood placement. Rotating globe mirror. 120mm Base 145mm High Amber in colour

Code  
TT1100



### WORK LIGHT

#### 12V FLUORO TUBE 13W

Bright fluoro lamp with hook for under bonnet, camp sites, etc. 12Vdc. Includes 3.0M cable to accessories plug. Special folded double lamp for extra bright. 370mm Long.

Code  
TT1104



#### LED WORK LIGHT

26X Super Bright LEDs. Rechargeable from mains or Car 12V. 435mm in length. Includes 12Vdc & 240Vac chargers.

Code  
WL3

### LIGHTER PLUG LED TORCH

#### RECHARGEABLE 12V

Clever design where the torch barrel fits direct into a cars accessories socket for charging. Smart, convenient, stylish. Machined aluminium with black rubber detailing. Push button on/off/flash 3x Ultra-bright LEDs Compact 65x27mmØ

Code  
RCT03

More Torches: See Section 12.



### RECHARGEABLE LED TORCH

#### WATER PROOF 6 LED

Super bright LED torch Torch for the glove box Always ready to go with Inbuilt 3x AAA NiMH cells combined with a constant voltage circuit for 30K Lux always maximum brightness Charges by included 12V accessories lead Compact 105x40mmØ

Code  
TGR303



More Torches: See Section 12.

## ↓ Misc Decorative

### WINDSCREEN WASHER LEDS

#### OPTO-GLOW HIGHLIGHTERS

Replaces existing washer nozzles (& still function) Super-Bright LEDs facing forward down the bonnet 12Vdc hard wire connect Gun-Metal dark grey With rubber grommet Premium grade item.

Colour Code  
Blue EL4B  
White EL4W



### TYRE VALVE LEDS

#### OPTO-GLOW HIGHLIGHTERS

Attaches to valve stems of your tyres & highlights while the wheel spins Button battery operated. Centrifugal force causes the units to switch on! Chromium metal made Premium grade item

Colour Code  
Red EL3R



### ORNAMENT LEDS

#### BEATS TO THE MUSIC

5cm (2") Dash ornament Accessories plug end 3M cable switched Permanent on or sound sequenced Magnetic base adjustable

Colour Code  
Blue EL12B



### T10 WEDGE TYPE LED COLOUR LIGHTING

4 Super-Bright LEDs

Colour Code  
White T104W  
Blue T104B  
Red T104R  
Yellow T104Y





## ↓ Interior Lights

### T10 WEDGE TYPE LED LIGHTING

**2x Super SMD LED**  
Dual super SMD LED lights  
Ultra White 6500 Kelvin

Colour Code  
White T102W



**9 SMD 3D LED**  
6xSMD+ 3x Super SMD LED lights  
Ultra White 6500 Kelvin

Colour Code  
White T105W



**9x SMD Long 3D LED**  
9 super SMD LED lights  
Ultra White 6500 Kelvin

Colour Code  
White T109TW



**12x SMD LED**  
12 super SMD LED lights  
Ultra White 6500 Kelvin

Colour Code  
White T1012TW



### FESTOON TYPE REPLACEMENT LED LIGHTING

12V DC. 6500 Kelvin. Ultra White.  
Replaces original interior light.

**6x Super SMD LED**

Size Code  
41mm SMD95W



**6x Super SMD LED**

Size Code  
36mm SMD93W  
41mm SMD94W



**4x Super SMD LED**

Size Code  
28mm SMD91W

**6x Super SMD LED**

Size Code  
28mm SMD92W

### LED LIGHTING COLOUR KIT WITH ADAPTORS

12V DC. Includes adaptor kit.  
Replaces original interior light.  
Deluxe packaging with  
"Try-Me" push button!

**6x LED Interior Light**

Colour Code  
White SMD6W  
Blue SMD6B  
Red SMD6R  
Green SMD6G



**12x LED Interior Light**

Colour Code  
White SMD12W  
Blue SMD12B  
Red SMD12R  
Green SMD12G

**16x LED Interior Light**

Colour Code  
White SMD16W  
Blue SMD16B  
Red SMD16R  
Green SMD16G

### LED LIGHTING KIT WITH ADAPTORS

12V DC. 6500 Kelvin Ultra White.  
Replaces original interior light.  
Deluxe packaging with  
"Try-Me" push button!

**4x Super SMD LED**

Colour Code  
White SMD81W

**6x Super SMD LED**

Colour Code  
White SMD82W

**8x Super SMD LED**

Colour Code  
White SMD83W

**12x Super SMD LED**

Colour Code  
White SMD85W



The festoon adaptor is adjustable in length to suit 3 different sized globes 28, 31 and 36mm.

# LEDZ

Hyperformance

## SUPER SMD LED

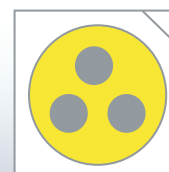

3 times the light

Each Super SMD LED is in-fact 3 Surface mount led's in one package.  
The performance of a Super SMD LED is far superior to a standard LED.



## → Interconnects & Wire

### ↓ Amp Wiring Kits

#### 0 AWG 2000 WATT POWER CABLE KIT

##### MEGA POWER AMP KIT 250A

No fuss installation solution. Saves time! Ideal for the newer, hungrier digital amps. Cable is the attractive transparent style.

6M 0-Gauge Red Power cable with terminal. 1M 0-Gauge Silver Ground cable. 6M 18 Gauge Blue Trigger Cable. In-line ANL Fuse Holder. 250 Amp ANL Fuse. Packed in full colour giftbox.

Code  
MX000



#### 2 AWG 1500 WATT POWER CABLE KIT

5.5M 2 Gauge Red Power Cable with terminal. 0.8M 2 Gauge Silver Ground Cable. 5M 20 Gauge Blue Trigger cable. 1.8M Split Loom Tubing Black For fire retardant protection In-line ANL Fuse Holder and 2x distribution blocks (+/-) With 4x 4AWG Cable connections Includes 180 Amp ANL Fuse. Excellent installer solution. Packaged for resale.

Code  
MX002



#### 4 AWG 1000 WATT POWER CABLE KIT

6.0M 4 Gauge Red Power Cable To O-Ring 0.8M 4 Gauge Black Ground Cable To O-Ring 5M 20 Gauge Blue Trigger cable. 1.8M Split Loom Tubing Black For fire retardant protection In-line ANL Fuse Holder and Includes 120 Amp ANL Fuse. 6pcs of cable ties. Excellent installer solution Packaged for resale.

Code  
MX004



#### 8 AWG 300 WATT POWER CABLE KIT

6M 8 Gauge Red Power Cable. ½M Black Ground Cable. 6M 18GA Blue Trigger Cable. In-line AGU Fuse Holder. 40 Amp AGU Fuse.

Code  
AP953



#### 8 AWG 600 WATT POWER CABLE KIT

##### 200W RMS WITH 60A AGU FUSE

Amp power wiring kit provides you with blistering performance and uses up-specked components, stunning cosmetics and maximum inclusions with plenty of speaker wire. 6m 8 AWG braided power cable with O-ring terminal preinstalled. 0.8m 8 AWG braided ground cable with O-ring terminal preinstalled. AGU fuse assembly with 60A fuse. Hex key included for installation of custom fuse holder. 8 AWG grommet. 5m 20 AWG trigger wire with fork terminal preinstalled. 6pcs cable ties. 1.8m split loom tubing.

Code  
MX008





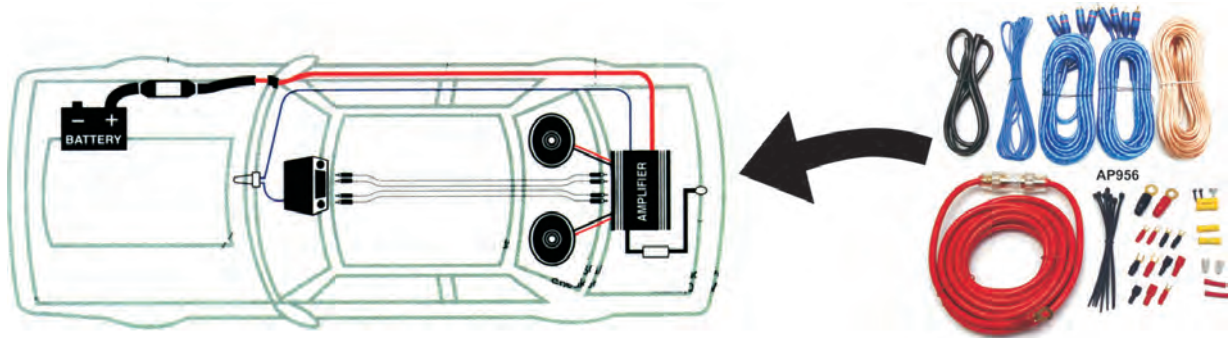

## 6 AWG 600 WATT 4-CH AMP CABLE KIT

### POWER & AUDIO QUAD

5M Clear Blue Double Shield RCA Cable [4x Male to 4x Right-Angled  
Silver plated AGU Fuse Holder including 50 Amp AGU Glass Fuse Male.]  
6M 6AWG Red Power Cable  
1.2M 6AWG Clear Black Ground Cable  
5.5M 18AWG Blue Trigger Wire  
10M 14AWG Clear Speaker Cable  
Supplied with all terminals and installation equipment.

Code  
PS91



## 8 GA 450W MAX AMP WIRING KIT

4 channel 8 gauge 450W amp wiring kit. Provides you with value for money with up-specked components and maximum inclusions.

- 5.5m red 8 GA power cable with O-ring terminal
- 0.8m black 8 GA ground cable with O-ring terminal
- 50A AGU fuse with holder
- Hex key for fuse holder
- 2pcs 5m 2 male to 2 male RCA lead
- 8 GA grommet
- 20 GA blue trigger wire
- 4pcs fork terminals for speaker cable
- 4pcs small speaker terminals
- 4pcs large speaker terminals
- 12pcs cable ties
- 1.8M split loom tubing

Code  
BSX408



## 8 GA 450W MAX AMP WIRING KIT

2 channel 8 gauge 450W amp wiring kit. Provides you with value for money with up-specked components and maximum inclusions.

- 5.5m red 8 GA power cable with O-ring terminal
- 0.8m black 8 GA ground cable with O-ring terminal
- 50A AGU fuse with holder
- 5m 2 male to 2 male RCA lead
- Hex key for fuse holder
- 8 GA grommet
- 20 GA blue trigger wire
- 4pcs fork terminals for speaker cable
- 4pcs small speaker terminals
- 4pcs large speaker terminals
- 12pcs cable ties
- 1.8m split loom tubing

Code  
BSX208



## 8 AWG 300 WATT 2-CH AMP CABLE KIT

### POWER & AUDIO STEREO

6M 8AWG Clear Red Power Cable 1M 8AWG Clear  
Black Ground Cable 5M 18AWG Blue Trigger Wire  
5M Clear Blue Double Shielded RCA Cable [2x  
Plugs to 2x Right-Angled Plugs.] 9M 14AWG Clear  
Speaker Cable Supplied with all terminals and  
installation equipment.

Code  
PS90





# 18 CAR AUDIO ACCESSORIES

18 CAR AUDIO ACCESSORIES

## ↓ Power Cable

### EXTREME-POWER OFC INTERCONNECT

Pure Oxygen-Free Copper Power Interconnect. Incredible current limits beyond measurement. Automotive grade red tinted outer jacket. For shorter lengths see our installation kits. Available in RED on 30 Metre reels.

#### 2AWG 6.5mmØ + Jacket

Colour	Length	Code
Red	30M	BSX230R



### HIGH-POWER OFC INTERCONNECT

High Grade Flexible 99.95% OFC SoundLink in Red or Black.

#### 4AWG 180A 5.2mmØ Jacket 10mmØ

Colour	Length	Code
Red	50M	APC1040
Black clear	30M	BSX430B



#### 8AWG 92A 3.3mmØ Jacket 7mmØ Transparent Jacket

Colour	Length	Code
Red	50M	APC1280
Black	50M	APC1281

### LOW-POWER OFC INTERCONNECT

#### SINGLE WIRES FOR ACCESSORIES CONNECTIONS

Single small gauge cable with 3mm O/D colour coded jacket for low power car accessories, trigger wires, etc. Rated peak 5A for short lengths. Supplied 100M Reels.

#### 15 AWG ACCESSORIES CABLE 100M

Colour	AWG	Code
Black	15	AP915BK
Red	15	AP915R
Blue	15	AP915BU
Green	15	AP915GN



#### 16AWG "TRIGGER" CABLE 100M

Colour	AWG	Code
Orange	16	MX16100

### AUTOMOTIVE TWIN POWER CABLE

Red & Black pair for speakers or DC power Extra thick PVC jacket for protection in high wear and hostile environments Multi-stranded copper litz wire pair Figure 8 cable. Supplied on 100M reels

#### 12AWG 15A HEAVY DUTY JACKET

61x0.18mm Strands. 2x4.5mm Jacket.

Code
AW1861

#### 18AWG 10A HEAVY DUTY JACKET

37x0.12mm Strands. 2x3.5mm Jacket.

Code
AW1237



## ↓ Accessories

### AUTOMOTIVE SPLIT LOOM TUBING

Split down the middle for easy application & wiring. Protective ribbed casing, like a vacuum hose, so will bend for easy installation. Diameter does not stretch. Strength along the diameter. UV black ABS plastic.

Size	Code
7mm x 10M	SLT7
10mm x 10M	SLT10
16mm x 10M	SLT16

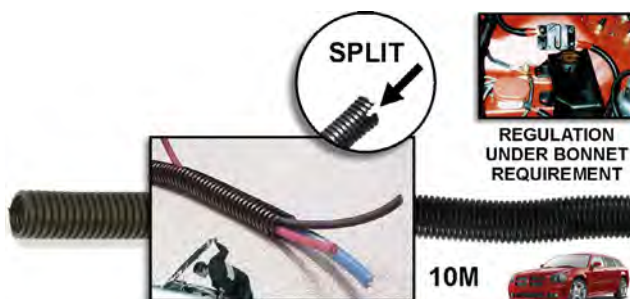

REGULATION UNDER BONNET REQUIREMENT

Recommended Cable Size by Power and Distance					
Total RMS	1M	2M	3M	4M	5M
100 W	10 AWG	10 AWG	8 AWG	8 AWG	4 AWG
200 W	10 AWG	8 AWG	8 AWG	4 AWG	4 AWG
400 W	8 AWG	8 AWG	4 AWG	4 AWG	4 AWG
600 W	8 AWG	4 AWG	4 AWG	4 AWG	4 AWG
800 W	4 AWG	4 AWG	4 AWG	2 AWG	2 AWG
1000 W	4 AWG	4 AWG	2 AWG	2 AWG	2 AWG
1400 W	4 AWG	2 AWG	2 AWG	2 AWG	2 AWG

Current Draw by Amp		Power Cable Specs	
Total RMS	Amps	Cable Size	Capacity
100 W	15A	16 AWG	300A
200 W	35A	2 AWG	275A
400 W	60A	4 AWG	150A
600 W	95A	8 AWG	100A
800 W	125A	10 AWG	60A
1000 W	150A	12 AWG	40A
1200 W	175A	14 AWG	25A
1400 W	180A	16 AWG	15A



## ↓ Speaker Cables

### PREMIUM QUAD OFC SPEAKER CABLE

#### FLAT SOUNDLINK UNDER CARPET CABLE

Four ply for Bi-Amping or stereo runs Flat for reduced cable capacitance and for under carpet, low-profile runs. Exceptional quality audio speaker cable \*Exotic woven ultra-thin 99.99% OFC 50M Reels (100M if split down the middle)

**4x 12AWG** 132x0.12mm [3x15mm Jacket]

Code  
OFC132

**4x 10AWG** \*384x0.07mm [2.5x21mm Jacket]

Code  
OFC384

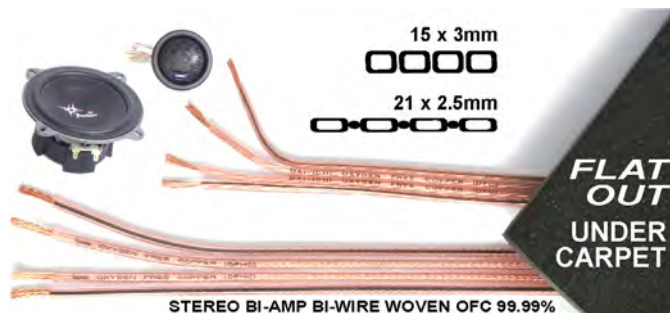

### PREMIUM OFC SPEAKER CABLE

#### SOUNDLINK OFC SPEAKER CABLE

Twin pair High Grade Speaker 99.95% OFC with Clear Jacket that is highly flexible. Suit professional installations. On reels.

AWG	Length	Code
18AWG	50M	AIC335
18AWG	100M	AIC1335
15AWG	50M	AIC727
15AWG	100M	AIC1727
13AWG	50M	AIC745
13AWG	100M	AIC1745
11AWG	50M	AIC772
11AWG	100M	AIC1772
9AWG	50M	AIC7109



### GENERAL PURPOSE SPEAKER CABLE

Twin (Figure 8) hook-up wire Suit general purpose install Speaker connect up-to 100Wmax Flexible. Polarised. Copper. Supplied on 100 Metre Reels.

AWG	Length mm	Jacket	Code
24AWG	100M	2x1.6mm Grey	SPW1611
22AWG	100M	2x2.5mm Grey	SPW1224
18AWG	100M	2x2.2mm Clear	SPW2024
20AWG	100M	2x2.5mm Clear	SPW1618
18AWG	100M	2x3.0mm Clear	SPW1641

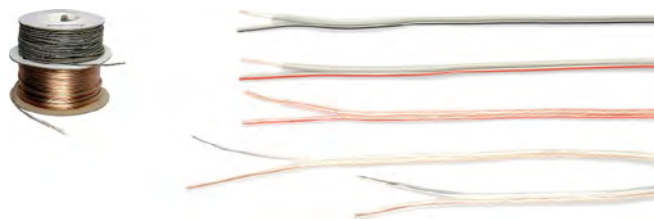

## ↓ Audio / RCA Cable

### SOUNDLINK OFC SHIELDED AUDIO CABLE

Low Loss 99.95% OFC & Aluminium Foil

**7mm OD Single Crimson**

Length Code  
50M AIC227

**8mm OD Single Blue**

Length Code  
50M AIC228

**4mm OD Twin Black**

Length Code  
100M SQS100

**6mm ODx2 Twin Dark Blue**

Length Code  
50M AIC236

**More Available**

Other Cable - Page 13-1

RCA Plugs - Page 7-1

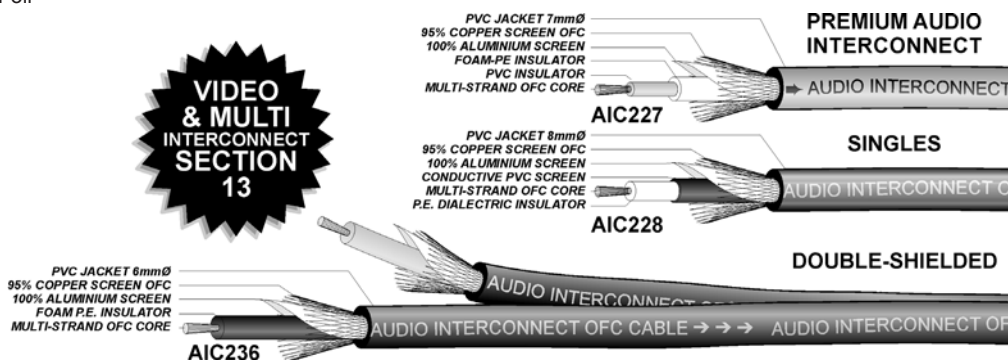

### HIGH QUALITY OFC INTERCONNECTS

**STEREO RCA TO RCA** 99.95% OFC Ready made Audio Connectors

Length	Code
0.1M	OFC606
0.8M	OFC607
1.5M	OFC608
3.0M	OFC612
5.0M	OFC614
8.0M	OFC615
15M	OFC616

**Y Connectors 0.1M**

Ends	Code
F To M/M	OFC622
M To F/F	OFC625





# 18 CAR AUDIO ACCESSORIES

18 CAR AUDIO ACCESSORIES

## → Power

### ↓ Capacitors

#### 1 FARAD STIFFENING CAPACITOR

**PREMIUM DYNAMICS**  
20 Volt High Current E.S.R.  
0.00198 Ohm 4 Digit Voltage  
Display Bolt contacts

**1,000,000 µF CAP**  
Round 250x75mmØ

Code  
AP-PC10

**2,000,000 µF CAP**  
Round 300x75mmØ

Code  
AP-PC20



### ↓ Noise Filter

#### NOISE SUPPRESSOR

Direct mount Condenser  
Capacitor for general  
ignition noise suppression.  
0.47µF EHV weather proof.

Code  
CNS2

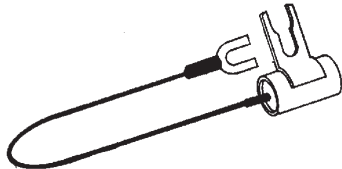

#### NOISE FILTER 40A

**CLEAN POWER 500W**  
15VDC Power through.  
25A Nom. 40A Max.

**INLINE TYPE**

Code  
AP958



#### NOISE SUPPRESSOR FILTER

##### SQUARE FILTER

Choke and Cap Fire-wall  
mount Weather resistant

Current Code  
5 Amp NS15S  
10 Amp NS20

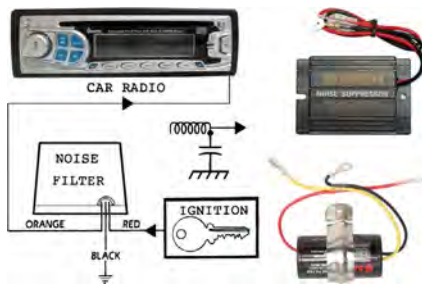

##### ROUND VERSION

50mmØ w/ bracket

Current Code  
5 Amp NS15R

#### NOISE SUPPRESSOR KIT

##### "Hot Line" FILTER

Comprises of one  
choke, 3µH(5A)  
or 1.5µH(10A) & a  
100µF Cap. For noisy  
ignition, etc.

Value Code  
5 Amp NS5  
10 Amp NS10

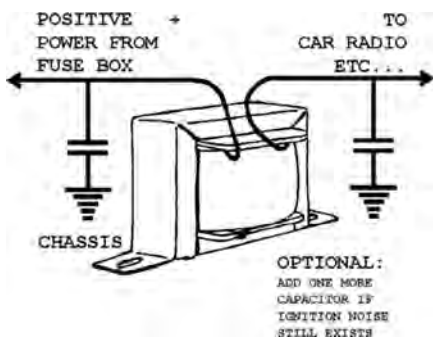

## ↓ 12VDC Power Accessories

#### DC LEAD 2A

**WITH DC PLUGS**  
Car Accessories Plug 2M Long  
lead Fused 2 Amp Includes 8  
popular DC Type plugs

Code  
MW-CP1



#### 12VDC-DC CONVERTER 800mA

**ADJUST 3→12V**  
Battery eliminator Converts  
Accessories to 3/4.5/6/7.5/9/12  
Volts Regulated output. Fused  
800mA Maximum Current  
500mA Continuous power  
Includes 6x DC Plugs

Code  
CA709



#### 12VDC-DC CONVERTER 1A

**SWITCH-MODE UNIVERSAL**  
12Vdc Accessories to  
1.5/3/4.5/5/6/9/12Vdc 1A Fully  
Regulated Suit games, CDs,  
etc. Includes 6x DC Plugs.

Code  
SDR0121A



#### 12VDC-DC CONVERTER 3A

**SWITCH-MODE UNIVERSAL**  
12Vdc Accessories to  
9/10Vdc 3A Fully Regulated  
12Vdc 2A Fully Regulated.  
1.7x4.75mm EIAJ DC Plug or  
3.3x5.5mm EIAJ DC Plug

Code  
SDR30W



#### 12VDC-DC UP CONVERTER 3A/6A/8A

##### UNIVERSAL LAPTOP 15V→24V SWITCH-MODE STEP-UP

Description	Code
15/16/18/19/20Vdc @3.5A 22/24Vdc @2.9A Output.	SDR70W
15/16/18/19/20Vdc @6.0A 22/24Vdc @5.0A Output.	SDR120W
15/16/18/19/20Vdc @8.0A 22/24Vdc @6.0A Output.	SDR150W

Includes 5x DC Plugs.



#### 12VDC TO LAPTOP

##### INTELLIGENT SUPPLY

Car accessories  
powered adaptor.  
Suits a majority of  
laptops. Outputs 12Vdc  
to 24Vdc up to 90W.  
Voltage automatically  
selected by the plug  
chosen. Includes 10  
Plugs. See Section 12  
for details...

Code  
LS-CR90AA



Supply power  
Charging



## ACCESSORIES EXTENSION

### EXTENSION LEAD

3 Metre Curly 10A

Code  
CA600



## ACCESSORIES EXTENDER

Splits to Two sockets out. Suitable for holding up accessories, etc.

### DUAL HEAD R/A

Right angle side entry or Locking angle adjustment.

Code  
API89192

### DUAL HEAD

Locking angle pair.

Code  
CAS2



## ACCESSORIES DOUBLE ADAPTOR

### SOFT

5A Fused Drop cable type Accessories only

Code  
DCL30

### HARD

15A Fused Sturdy hold type High temp ceramic 12V Sockets Accepts lighter

Code  
DCP320



## ACCESSORIES TRIPLE/QUAD ADAPTOR

Loose cord type 2x (3x) 3A Sockets 1x High-Temp Socket

### TRIPLE ADAPTOR

Code  
DCP330

### QUADRUPLE ADAPTOR

With status indicator 3 LED Hi/Normal/Low

Code  
CA700



## DC 12V/24V POWER DISTRIBUTION

### 3 WAY LED 12V SOCKET ADAPTOR UNIVERSAL WITH USB SOCKET

Three way 12V DC sockets with 5 Volt USB socket (5V/500mA). Converts single 12V Cigarette lighter socket to 3 sockets. Blue LED illumination. Allows charging of USB devices such as Digital music players, cameras, mobile phones etc. Packed in hang sell blister. Total capacity 10 Amps. Size : 115x45x30mm

Code  
APL3USB



## MEDIA ACCESSORY CHARGER

### USB CHARGER & SPLITTER

Powers via USB Socket Outputs 5V 500mA Great battery saver or charger solution. Extra 12Vdc sockets for phones, GPS, etc. Fuse protected. 1x USB & 3x 12Vdc

Code  
CAS-3USB



## MEDIA ACCESSORY CHARGERS

### USB CHARGER

Powers via USB Lead Outputs 5V 500mA To USB-B Socket Great battery saver or charger solution. Assorted Styles.

Style	Code
White	API89113
Flex	USBS30
Flush	USBM20



## iPOD® ACCESSORY CHARGERS

### DOCKING PORT POWER

Powers via accessories Outputs 5.1V 1A To Docking Socket Great battery saver or charger solution.

Code  
ELI9002



## MINI USB CAR POWER ADAPTOR

### USB-Mini-5B PLUG

Power/Charge USB devices from the car accessories Suits many devices such as GPS, MP3, Cameras, etc. Mini USB 5 Pin plug Power out 5Volt 1Amp

Plug	Code
Mini USB Male	ELI5725
Mini USB Male	ELI5726
Mini USB Male	ELI5727
Mini USB Male	ELI5728



## MICRO USB CAR POWER ADAPTOR

Curley cord DC adaptor.

Plug	Amps	Code
Micro USB Male	650mA	ELI1001
Micro USB Male	2A	ELI1005



## GAME CONSOLE POWER

### PSP CAR POWER

Code  
ELI-PSP

### PS-II SLIM

Code  
ELI-PS2

### GameBoy ADVANCED

Code  
CG363

### GameBoy SP

Code  
ASP1002

### GameBoy Micro

Code  
ELIGB101

### DS-LITE

Code  
ELIGB100



SEE GAMEDMASTER FOR MORE

## MOBILE PHONE

### ELI SERIES

CARMAX In Car Chargers Available from Cellink Compact replacement type 12Vdc car chargers suit Mobile phones, PDAs, GPS, and more...

### CELLINK

Ask for a Catalogue! or visit: [www.cellink.com.au](http://www.cellink.com.au)





# 18 CAR AUDIO ACCESSORIES

18 CAR AUDIO ACCESSORIES

## ↓ 24VDC to 12VDC Reducers

### 24V TO 12V DC-DC REDUCERS GSL

#### LINEAR TYPES GSL

Converts 24V Systems to the lower 12V accessories output for popular items.

True RMS power ratings Suit Audio & Phone, etc. High short term peak cycles Suit CB UHF Radio, etc. Extruded aluminium black Quality build long-life

Made tough for Australia Full unconditional protected

See section 12 AC POWER for more GSL

**3A (5A peak)** 135x80x40mm

Code  
DC24123

**4A (6A peak)** 135x115x50mm

Code  
DC24125

**7A (10A peak)** 160x115x50mm

Code  
DC24127

**10A (15A peak)** 225x115x50mm

Code  
DC241210



### 24V TO 12V DC-DC REDUCERS

#### COMPACT GENERAL PURPOSE UNITS

Designed for use where a 24Vdc vehicle (Buses and Trucks, etc.) Requires 12Vdc devices installed Simply wires inline with ignition accessories voltage to the unit. Open style so requires mounting in a protected, ventilated area. Chassis mount. Negative ground. 24 Volts input 13.8 Volts output. Priced right!

**8A max 10A max**

123x100x65mm

Code  
AP828

**15A max**

123x100x65mm

Code  
AP8285

**30A max**

123x200x65mm

Code  
AP830



24V  
TO  
12V

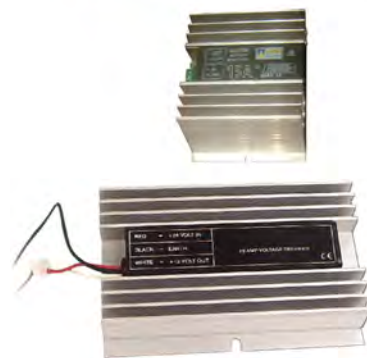

### 24V TO 12V DC-DC REDUCERS GSL

#### MAXIMISER SWITCHMODE TYPES

For higher power ratings in a professional package. Premium grade. Features efficient conversion for a cooler and longer life. Compact convenient mounting. Soft Start Smart Operation. Ratings are continuous RMS Peak current is 10% above this but is not recommended. Protected from voltage spikes, incorrect wiring, short circuits, Over/Under voltage, thermal, Earth loss, over current, etc. Premium grade product. 20 → 30Vdc.

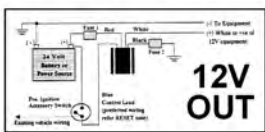

**20 AMP**

Size 155x115x65mm

Code  
DC241220

**30 AMP**

Size 220x115x65mm

Code  
DC241230



### 24V TO 12V DC-DC REDUCER 30A

#### HIGH POWER 30A

Blue aluminium compact case Fused and power switched Internal cooling fan. Built in indicating LED: Green for go, red for protection. C-Tick approved. 180x100x50mm 24 Volts input. 14 Volts output. 30 Amp maximum.

Code  
AP829



## ↓ Battery Isolator

### ELECTRONIC BATTERY ISOLATORS

#### ADD AN EXTRA BATTERY CONNECTION

Connect two batteries to the one charging circuit. The primary battery is for vehicle operation. The Auxiliary battery is for your equipment, eg. inverters, fridge, etc. The primary battery is always in the charging circuit. The auxiliary battery is disconnected if below 11.4V This protects you from ever having two flat batteries!

Current Code  
100A EBI-100  
150A EBI-150





## ↓ 12VDC to 240VAC Invertors

### 12V TO 240VAC INVERTERS

#### ACCESSORIES PLUG UNIT

Modified sinewave output Compact convenient solution Safety protected socket door Car and appliance protection Suits general low-power items like chargers, lights, etc.

**75 Watt**

Code  
CAI-75

**150 Watt**

Code  
CAI-150



### 12V TO 240VAC INVERTER

#### ACCESSORIES PLUG INPUT

Modified sinewave output Compact convenient solution Safety protected socket door Car and appliance protection High power circuitry in a compact aluminium box & fan With Low-Battery alarm 350W rms and 700W peak

**350 Watt**

Code  
CAI-350



### 12V TO 240VAC INVERTERS

#### GSL TRAVELLER SERIES

Modified sinewave output Low battery alarm & shutdown Multiple circuit protection Over/Under voltage, thermal Overload & short circuit, etc. Heavy-duty construction Light-weight aluminium Heat sink casing with fans 92% High efficiency design LED Displays status modes Voltage & Load level display (on the KiloWatt versions) Quality long-life products Made in Australia from GSL

[www.gsl.com.au](http://www.gsl.com.au)

**150W rms 300W surge**  
140x102x65mm Acc' plug.

Code  
INV150-12

**350W rms 700W surge**  
190x102x65mm Acc' plug.

Code  
INV350-12

**600W rms 1200W surge**  
285x180x85mm

Code  
INV600-12

**1500W rms 3000W surge**  
445x220x95mm Acc' plug.

Code  
INV1500-12



INV150-12

INV350-12

INV600-12

INV1500-12

### 12V TO 240VAC INVERTER

#### 150W AERPRO W/ USB

Accessories plug 12Vdc In Modified Sinewave 240Vac Out Compatible with most items even some sensitive units like laptops, AV, etc. Modern media white Bonus dual USB sockets used for charging/powering additional USB accessories

**150W**

Code  
AIU150



### 12V TO 240VAC INVERTER

#### 100W rms / 250W surge

Compact aluminium cabinet Accessories plug 12Vdc In Modified Sinewave 240Vac Out Compatible with most items even some sensitive units like laptops, AV, etc. Overload & thermal protected with alarm

**250W**

Code  
INVERT100



### PURE-SINE-WAVE INVERTERS

#### CITY POWER ON THE MOVE!

Low noise pure sine wave removes many problems caused by modified sinewave inverters Appliances run smoother & cooler. TV Monitors are crystal clear Induction motors start better reducing turn-on surge demands. Essential for some equipment especially sensitive technology and medical equipment, etc. Also appliances that use the mains as a timing reference. Very high 300% surge currents GSL manufacture their products with greater quality control specifically for Australian conditions.

[www.gsl.com.au](http://www.gsl.com.au)

**150W rms 450W surge**  
Accessories plug. 225x130x90mm

Code  
SW150-12

**350W rms 1050W surge**  
Accessories plug. 225x130x90mm

Code  
SW350-12

**650W rms 1950W surge**  
Accessories plug. 350x270x120mm

Code  
SW650-12

**1200W rms 3600W surge**  
Accessories plug. 475x270x120mm

Code  
SW1200-12



SW150-12



SW350-12



SW650-12



SW1200-12



# 18 CAR AUDIO ACCESSORIES

18 CAR AUDIO ACCESSORIES

## → Interconnects & Wire

### ↓ Crimp Terminals

#### QUICK DISCONNECT KIT

##### 300 PIECES

21cm box full of popular terminators Sizes 22AWG → 14AWG Ring, Spade, Bullet & quick disconnects Excellent crimp plug solution if only small quantities are required Clear compartment box Box 210x110x30mm



Code  
TMK300

#### BULLET CONNECTORS MALE

Type	TAB	AWG	Code
Male	4mm	22-18	TM24151
Male	4mm	16-14	TM24152
Male	5mm	16-14	TM24192
Male	5mm	12-10	TM24193



#### QUICK DISCONNECT TERMINALS FEMALE

Type	TAB	AWG	Code
Female	6.4mm	22-18	TM20251
Female	6.4mm	16-14	TM20252
Female	6.4mm	12-10	TM20253
Female	4.7mm	22-18	TM20181
Female	4.7mm	16-14	TM20182
Female	2.8mm	22-18	TM20111



#### BULLET CONNECTORS FEMALE

Type	TAB	AWG	Code
Female	4mm	22-18	TM25151
Female	4mm	16-14	TM25152
Female	5mm	16-14	TM25192
Female	5mm	12-10	TM25193



#### QUICK DISCONNECT TERMINALS MALE

Type	TAB	AWG	Code
Male	2.8mm	22-18	TM21111
Male	4.7mm	22-18	TM21181
Male	4.7mm	16-14	TM21182
Male	6.4mm	22-18	TM21251
Male	6.4mm	16-14	TM21252
Male	6.4mm	12-10	TM21253



#### RING TERMINALS

Stud.	AWG	Code
8mm	16-14	TM10142
8mm	12-10	TM10143
6.4mm	22-18	TM10121
6.4mm	16-14	TM10122
6.4mm	12-10	TM10123
5.3mm	22-18	TM10101
5.3mm	16-14	TM10102
5.3mm	12-10	TM10103
4.3mm	22-18	TM10081
4.3mm	16-14	TM10082
4.3mm	12-10	TM10083
3.7mm	22-18	TM10061
3.7mm	16-14	TM10062



#### QUICK DISCONNECT TERMINALS INSULATED

TAB	AWG	Code
6.4mm	22-18	TM22251
6.4mm	16-14	TM22252
6.4mm	12-10	TM22253
4.7mm	22-18	TM22181
4.7mm	16-14	TM22182
2.8mm	22-18	TM22111
2.8mm	16-14	TM22112



#### SPADE TERMINALS

Stud.	AWG	Code
6.4mm	22-18	TM11121
6.4mm	16-14	TM11122
6.4mm	12-10	TM11123
5.3mm	22-18	TM11101
5.3mm	16-14	TM11102
5.3mm	12-10	TM11103
4.3mm	22-18	TM11081
4.3mm	16-14	TM11082
4.3mm	12-10	TM11083
3.7mm	22-18	TM11061
3.7mm	16-14	TM11062



#### BUTT SPLICES

AWG	Code
22-18	TM40001
16-14	TM40002
12-10	TM40003

Splices into an existing cable and an extra cable so as to "Tap" Inline without complication.



#### TAP SPLICES

AWG	Code
22-18	TM42001
16-14	TM42002
12-10	TM42003







## ↓ Audio / RCA Cable RCA Plugs & Adaptors

### RCA LEADS WITH REMOTE TRIGGER

**ELECTRIC BLUE PVC & WHITE PEARL**  
Hi-performance Audio Leads with OFC Cable.  
Includes Remote Trigger wire to turn amp on.

Type	Length	Code
OFC Blue	0.1M	OFC606
OFC Blue	0.8M	OFC607
OFC Blue	1.5M	OFC608
OFC Blue	3.0M	OFC612
OFC Blue	5.0M	OFC614
OFC Blue	8.0M	OFC615
OFC Blue	15M	OFC616



### 3.5mm ADAPTOR LEADS

#### 3.5mm TO RCA LEAD

Length	Code
1.2M	AL656

#### 3.5mm TO RCA ADAPTOR

Code
AD1230

#### 3.5mm PLUG TO PLUG

Length	Code
1.2M	AL720

#### 3.5mm EXTENSION M→F

Length	Code
5.0M	AL728



More Available Please Enquire

### RCA ADAPTORS GOLD PLATED

#### PLUG TO PLUG

Code
AD950

#### SOCKET TO SOCKET

Code
AD955

#### RIGHT ANGLE PAIR

Type	Code
Short	AD962
Long	AD960

#### DOUBLE ADAPTOR

Code
AD965

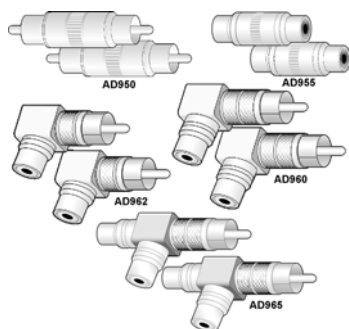

## ↓ Switches

### ARMING SWITCH

#### SPST TOGGLE 12V 20A

A universal nitrous arming switch ON-OFF position, Led indicator flip cover. 12VDC 20A. 80x50x17mm.



Colour	Code
Blue	SW403BU
Red	SW403RD
Green	SW403GN

### IGNITION BUTTON

#### N/C & N/O MOMENTARY

Push Start Ignition Switch with LED indicator. N/O, N/C and indicator light. 28mmØ. 12VDC 20A. 85x33x30mm.



Colour	Code
Blue	SW402BU
Red	SW402RD

### CUT-OFF SWITCH 100A

#### 12V/24V 100A

Removeable key so you can take it with you to prevent unauthorized use of your boat, race car, industrial equipment, etc.



Code
SW401

### CUT-OFF SWITCH 400A

#### 60V EXTRA HEAVY DUTY

400A battery Cut Out Switch with removable key



Code
SW400

## → Installation & Accessories

### ↓ LED & LAMPS

#### INDICATOR DIAL LAMPS 12V

**CHROME BEZEL 10mm**  
Incandescent. Convex. Lamp  
12V. 8mmØ Hole.

Colour	Code
Green	PL5GN

**CHROME BEZEL 10mm**  
5mm LED 12V. 8mmØ Hole.  
Raised chrome bezel.

Colour	Code
Red	PL6R
Green	PL6GN
Yellow	PL6YL



#### INDICATOR DIAL LAMPS 12V

##### PLASTIC LAMP 8mm

Incandescent globe.  
12V. 7mmØ Hole.

Colour	Code
Red	PL8R
Green	PL8GN

##### PLASTIC LAMP 22mm

Incandescent globe. Square bezel lamp. 12V. 15mmØ Hole.

Colour	Code
Orange	PL3



#### INDICATOR & DIAL GLOBES 12V

##### SEE SECTION 2 COMPONENTS

As used in switches and dash indicators Fuse lamp ¼x1¼" 3AG

Code
754-12

##### 3MM BI-PIN LAMP

Voltage	Code
14V	BIP3125

##### 5MM PUSH LAMP

Voltage	Code
12V	IL50-12



## ↓ Relays

### AUTOMOTIVE RELAY

#### 30A SPDT ¼"

"Bosch" Type Popular standard Single Pole Double throw 12V Coil 150mA 6.35mm Spade lugs 1 Inch³ Plastic Mounting Tag Weather proof Switches 30A

Code
TW3415

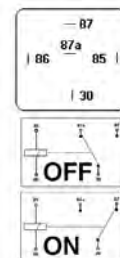

### RELAY SOCKETS

#### SUIT TW3415

Popular standard Suit "Bosch" type High current 30A Push-fit holders

#### SOLDER TERMINALS

Code
TW3417

#### 80CM WIRE LOOM

Code
TW3416





# 18 CAR AUDIO ACCESSORIES

18 CAR AUDIO ACCESSORIES

## ↓ Converters / Isolators

### FLOATING GROUND ADAPTOR

Converts car stereo outputs that are floating earth (BTL) into common ground for connection to Equalizer/Boosters etc. which have common ground in.

Code  
FGA10

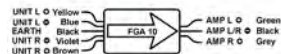

### SPEAKER TO RCA CONVERTER

#### STEREO ISOLATOR

Connect speaker out wires to a high power amplifier with RCA connection inputs Total earth isolation with high quality core transformers Adjustable output levels fr = 10Hz → 50KHz ±1dB Base 65x90(x28H)mm

Code  
AX-HL



### SPEAKER TO RCA CONVERTER

Accepts both 'Common Ground' input as well as 'Floating Earth' or 'BTL' type. Output is RCA With Volume Trim for L & R. Metal box. Gold plugs.

Code  
AP304



### GROUND LOOP ISOLATOR

#### STEREO 2xRCA I/O

Stereo audio 4K Ohm RCA Gold RCA plugs to sockets. Kill buzzes and hum in Car stereo, PA, etc. Fr = 40Hz → 40KHz ±3dB

Code  
ES11

#### DELUXE METAL

Fr = 10Hz → 100KHz

Code  
AP305



## ↓ Crossovers

### SUBWOOFER X-OVER

Stereo 12dB Low-pass 12V active filter for subwoofer. Adjustable output levels 80/125/250Hz LP switch S/N 100dB THD 0.02%

Base Code  
65x90(x28H)mm AX100

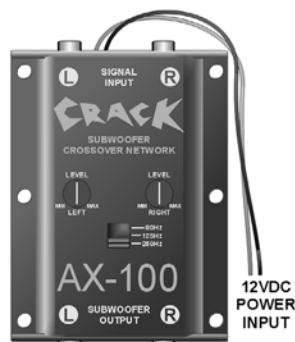

## ↓ AV Switch Box

### A/V SWITCH BOX

#### MANUAL SWITCH

All RCA connections Stereo Audio & Video

Type Code  
3way TP168  
4way TP178



#### REMOTE CONTROL

Uses any remote!



LEARNS USING EXISTING REMOTES

### AUDIO/VIDEO SWITCH & INTERCONNECTS - SECTION 08 PREPARED LEADS

## → Antennas

## ↓ Accessories

### CAR ANTENNA BOOSTER

This FM antenna booster will obtain clearer and stronger reception in fringe reception areas. It provides a 10dB gain over the FM spectrum. In-dash or under dash mounting, includes 53cm antenna cable and power cable. 12Vdc FM +10dB

Code  
AP342



### EUROPEAN ADAPTOR

#### BUILT-IN FM BOOSTER

Adapts Euro → Aust. Change a Standard radio to suit European antenna when installing a new radio into a European car. Ideal for demister antenna. 5-10dB FM Boosted.

Code  
AP3421

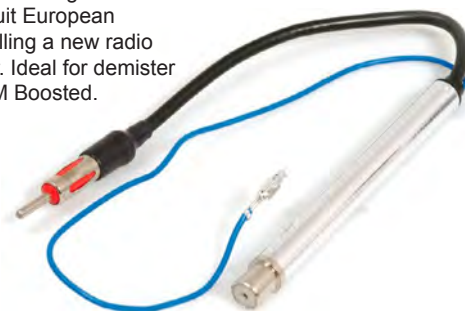

More antenna adaptors available! See antenna pages.....

### 20MHZ FM EXPANDER for JAPAN RADIO

#### SHIFTS FM BAND DOWN BY 20MHZ

Converts Australian FM frequency so it can be received by a Japan/Hong Kong Car Radio. Simply plug in-line with the existing car antenna. 12V

Code  
AP745





## → Adaptors / FM Transmitters

### CASSETTE ADAPTOR

#### 3.5mm AUDIO to Cassette

Allows an older cassette car stereo to accept an input from a portable unit Like CD/MD/MP3, etc. Transmits stereo through the Cassette deck. Simple!

Code  
CA747



### USB FLASH PLAYER & TRANSMITTER

#### BUILT IN USB MP3 DECODER & FM-TX

Car MP3 Transmitter flash drive. This unit can play hours of music stored on your own USB flash drive. Simply plug this into your car accessories socket then tune in the music through the car FM radio. Play Stop FF-Rew buttons. Reads MP3 Files

Code  
FMT220



### FM MODULATOR

#### RCA-IN TRANSMITTED TO FM-OUT

Allows you to Tune-In to an MP3 player or other external media device via RCA so you can listen to your music on the go! Direct inject antenna lead PLL tuning. Switch between 88.1 and 88.3MHz. Direct 12Vdc in. Plugs inline to car antenna.

Code  
AV8FM2



### iPOD iPhone TO FM TRANSMITTER CRADLE

iPhone FM Hands-Free Car kit and FM Audio Transmitter With Cigarette Mount Holder and iPhone iPod Charger.

Code  
CRA9003



### iPOD DIGITAL MEDIA CONNECT

#### FM TRANSMITTER

Inline style unit Two channel FM transmission Plug direct iPod into car FM radio.

Code  
AP7481



### CHARGER & TX KIT

#### FM MODULATOR FOR MP3

Universal installer unit suits a majority of MP3 CD/DVD Media players, etc. Includes FM Modulator Digital LCD Tune display PLL FM Stereo locked Accessories power unit for USB Charging 3.5mm or 2.5mm Stereo Line audio connection

Code  
ADM150TC



### FM MODULATOR PLUG

#### ACCESSORIES PLUG TX

Simply plug the attached 3.5mm stereo lead into your MP3 media device Tune your car radio in to your personal FM Station That's it! Sound on the go! 88.1/88.3/88.5 selector to dodge interference. Compact simple economical FM Stereo. 3.5mm lead inc.

Code  
AMPFMT35



### iPOD® MP4 CONNECTOR

#### 31 PIN W/ USB CONNECT

2M Connect to PC via USB USB also for powering Full break-out lead RCA Audio & Video out Connect iPod to TV, etc.

#### iPod® 31 Pin connector

Code  
API24CK





## → TV Tuner / System Converters

### TV TUNER FOR THE CAR

#### ANALOGUE TV TUNER BOX

Simple compact solution. Cypress quality. Receives Australian Analogue Broadcasts. 12Vdc hard-wired type box installation \*With the separated remote sensor for locating anywhere in the vehicle. Or home version has sensor on the box. Auto programming and channel memory. PLL with auto fine tuning for stable picture reception. Two RCA Composite Video outputs. Single mono audio output. Full function remote control PAL Socket aerial input Requires TV antenna

#### EXTERNAL IR\*

External IR sensor stealth.

Code  
CMT1C



### SYSTEM CONVERTER

#### NTSC/PAL/SECAM

RCA Composite Video In/Out in a compact 12Vdc package Automatically accepts any video system input and then converts it to a system as selected by dip switches. Premium picture quality and stability from Cypress using digital conversion and filtering technologies 6 Meg buffer for jitter-free 8 Bit RGB Conversion 13.5MHz 50/60Hz frame rate conversion 525/625 full resolution Low noise metal cased RCA Socket to Socket

Code  
ADC-660

#### 12V REGULATOR

For car connection

Code  
SDR30W



**WES Components**  
stock a comprehensive range of Cypress video accessories including system converters HD up-scalers, DVI Switches Signal processors, converters PC RGB YUV HDTV SCART  
[www.cypress.com.tw](http://www.cypress.com.tw)



### VIDEO TO VGA CONVERTER

#### WITH BUILT-IN TV TUNER

View Composite CVBS video or S-Video on any RGB (PC) Monitor. Easy to install and easy to use - External Box with remote control. Automatically accommodate video input systems of NTSC PAL and SECAM. Tuner is PAL socket aerial system for Analogue broadcast in Australia No compatibility issue - No operating system or hardware limitations.

Compatible with the HD15 Pin RGB-HV Computer type connections Excellent quality Full-screen & True-colour TV & Video display. Built-in Microprocessor with On-Screen Display (OSD) function. Built-in IR receiver input for infrared remote control (24 keys). Contrast, Brightness, Color, NTSC Tint adjustment. Channel select. One-touch key to switch between PC and external video. Integral Digital Line Doubler from 30 to 60 frame / sec. One Composite & one S-Video input for DVD, Game consoles, cameras, etc. PC loop-through allows for easy switch between video and PC input. Sound selection via 3.5mm stereo audio pass-through function. Dimension: 265(D) x 232(W) x 59 (H) mm. Beige. 240Vac to +12Vdc Adapter included.

Code  
CM-331T

#### 12V REGULATOR

For car connection

Code  
SDR30W





→ **Car Hands Free Kits**

↓ **Bluetooth**

**BLUETOOTH**

**LARGE RANGE AVAILABLE**

Too many items to list here! Continually evolving and expanding. Please contact Cellink for the latest Website: [www.cellink.com.au](http://www.cellink.com.au) Includes easy-install car kits From Professional installations to hobby 5 min installations. Many Mini-hands-free ear pieces Includes PC adaptors & dongles



**BLUETOOTH HANDSFREE**

**NON-INSTALLATION**

Full duplex & DSP Echo cancellation. Battery 160Hrs Desktop, visor, etc. Compact 12Vdc



Code  
ABT500

See Section 17 for many more!

↓ **ISO Speaker Interrupter**

**SPEAKER INTERRUPTER**

**ISO/UNIVERSAL ADAPTOR**

3.5mm Audio Plug connects to mobile Hands Free Kits (like the DS4000 Series) and interrupts the speaker wiring during a phone call. Music is automatically muted the caller now speaks through your car stereo speakers! 4 Pin control connector. Red+ Yellow control wire.

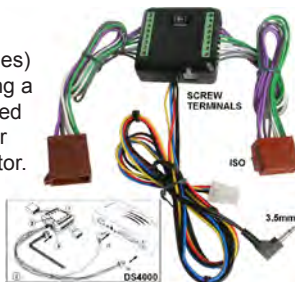

Code  
RMC112

**SPEAKER INTERRUPTER ISO**

**ISO ADAPTOR WITH POWER**

As above RMC112 with BOTH ISO Connectors for tapping Accessories power so as to make installation of the DS4000 Series even easier! ISO ONLY (Plugs hard wired) Can be adapted to other hands free with speaker out. 4 Pin control connector. Red+ Yellow control wire.



Code  
RMC113

→ **Reference**

**MOBILE PHONE HANDS FREE**

[www.cellink.com.au](http://www.cellink.com.au)

Due to the nature of the Mobile Phone Accessories Market, Our range of car hands-free kits is always continually evolving. See...

[www.cellink.com.au](http://www.cellink.com.au)



→ **Reference**

**CAR AUDIO SPEAKER PROJECTS**

**20 COMPLETE PROJECTS**

Get stuck straight into building! Talk about simple! This illustrated step-by-step guide makes leading edge car audio speaker systems easy. This book helps you plan, design & build the ultimate car audio. 244 pages. Dan Ferguson

Code  
MAN610

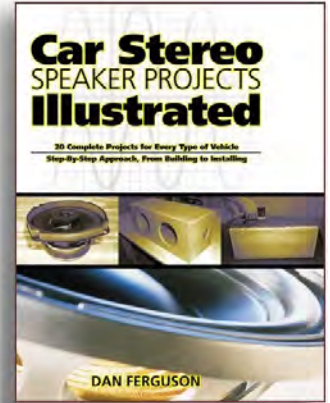

**SPEAKER DIY REFERENCE**

**DESIGNING BUILDING & TESTING YOUR OWN SPEAKER SYSTEM**

A complete reference to building speakers. It covers many types and models of speaker design principles and is aimed at the hobbyists, do-it-yourself audiophiles and specific enough for the electronic technician. 223 pages. David B. Weems

Code  
MAN600

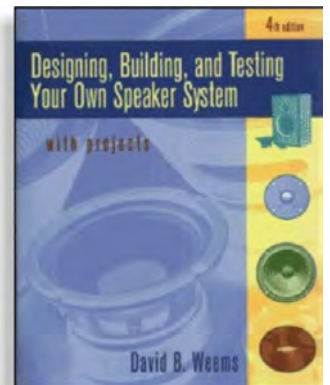

**MASTER ACOUSTIC REFERENCE**

**MASTER HANDBOOK OF ACOUSTICS**

For the more technically advanced who may want the ultimate in the reference for acoustic science. Easy reading explanations for Room acoustics, recording, studio, many topics in sound engineering. 615 pages. F. Alton Everest 4th ed.

Code  
MAN604

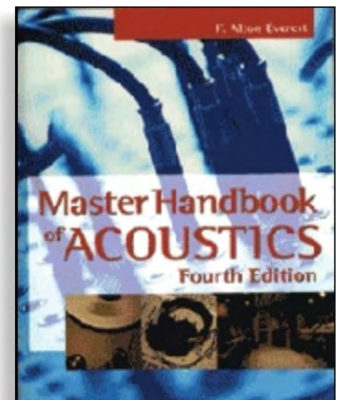



# 18 CAR AUDIO ACCESSORIES

18 CAR AUDIO ACCESSORIES

## → Fuses & Holders

### ATN FUSES 5 PACK

#### MINI 11mm BLADE FUSE X5

Order 1 to receive a box of FIVE.

Current	Code
5A	ATN5
7.5A	ATN7.5
10A	ATN10
15A	ATN15
20A	ATN20
25A	ATN25
30	ATN30



### ATS FUSES 5 PACK

#### MINI 11mm BLADE FUSE X5

Order 1 to receive a card of FIVE. Small version as used in head units

Current	Code
2A	ATS2
3A	ATS3
4A	ATS4
5A	ATS5
7.5A	ATS7.5
10A	ATS10
20A	ATS20
25A	ATS25
30A	ATS30
35A	ATS35



### ATS FUSES 50 PACK

#### MINI 11mm BLADE FUSE X50

Order 1 to receive a box of FIFTY Small version as used in head units

Current	Code
3A	ATS3-50
4A	ATS4-50
5A	ATS5-50
7.5A	ATS7.5-50
10A	ATS10-50
15A	ATS15-50
20A	ATS20-50
25A	ATS25-50
30A	ATS30-50
35A	ATS35-50



### ATC FUSES 5 PACK

#### POPULAR 18mm BLADE FUSE X5

Order 1 to receive a card of FIVE.

Current	Code
2A	ATC2
3A	ATC3
4A	ATC4
5A	ATC5
7.5A	ATC7.5
10A	ATC10
15A	ATC15
20A	ATC20
25A	ATC25
30A	ATC30
35A	ATC35



### ATC FUSES 50 PACK

#### POPULAR 18mm BLADE FUSE X5

Order 1 to receive a box of FIFTY As used in a majority of automotive.

Current	Code
3A	ATC3-50
4A	ATC4-50
5A	ATC5-50
7.5A	ATC7.5-50
10A	ATC10-50
15A	ATC15-50
20A	ATC20-50
25A	ATC25-50
30A	ATC30-50
35A	ATC35-50



### ATM FUSE BLOCK

Gold-Plated Fuse Block Clear plastic covered 8mm(x2) in, 6mm(x4) out. Suits "ATM" 28mm fuses.

Code  
FDB531



### ATM FUSES

#### MAXI 28mm BLADE FUSE

Mega version for high current units NOT ATC as above. Larger 1" style. Supplied 1 unit per hanger card

Code  
ATM20  
ATM30  
ATM40  
ATM50  
ATM60  
ATM70  
ATM80



### ATC INLINE FUSE HOLDER

General purpose Suit ATC plug-in fuses with wiring. Fuse not included. Fully insulated Fuse end viewable 30A Red Cable

Code  
JEF703

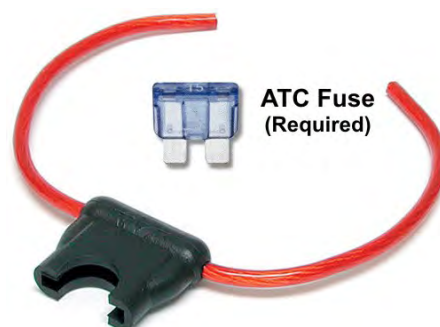

### ATC WATER RESISTANT HOLDER

#### ATC INLINE

Heavy duty design for use in unprotected places on boats, under car bonnets, etc. Fuse not included.

Code  
FH18

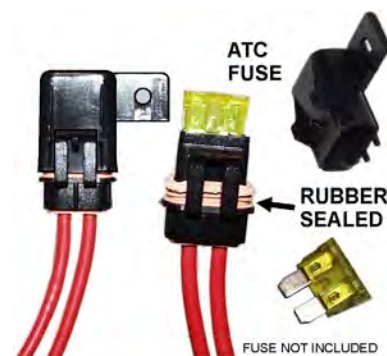

### ATC FUSE BLOCK

Designed for multiple hook-up of accessories, each with individual screw terminal outputs. Accepts up to six fuses. (Not included) See ATC

Code  
AFB400

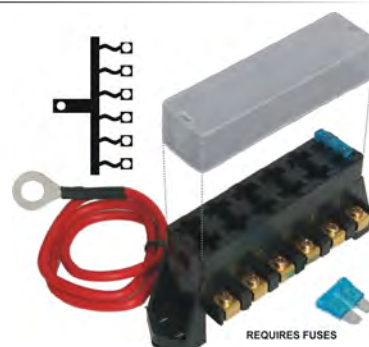



## → Fuses & Holders

### ANL FUSE HOLDERS

#### 0-2 AWG CABLE

Requires a fuse Rubber grommets  
5mm to 12mm entry Engine bay  
sealed Mounting flange Clear  
plastic Gold plated Heavy duty  
screw terminals Very high current

Code  
AP462

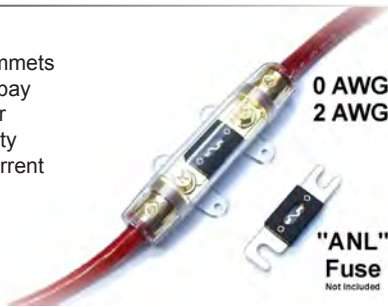

### ANL FUSES

#### 2" BLADE FUSE

Very high power fuse Low voltage (32Vdc) VERY HIGH current!  
Very low resistance Popular SPL choice Gold plated tinned  
Suits AP462 holder

Current	Code
80A	ANL80
100A	ANL100
150A	ANL150
200A	ANL200



### ANL FUSES

#### BUY 1 TO RECEIVE 2

Mini version of the ANL fuse straps.  
Sold packaged in packets of TWO.

Amps	Code
50	AMA50
60	AMA60
80	AMA80
100	AMA100
120	AMA120



### AGU FUSE HOLDERS

#### 4-8 AWG CABLE

Requires a fuse Rubber grommets Engine bay  
sealed Mounting flange Clear plastic Gold plated

Code  
FH512



### AGU FUSED DISTRIBUTION BLOCKS

Gold plated AGU with clear plastic heavy duty cover.  
Uses 10→60A AGU type fuses. Single in, multiple out.

#### 4AWG → 2x8AWG

Code  
FDB526

#### 4AWGx2 → 4x8AWG

Code  
FDB524



### AGU FUSES

#### 38x10mm 5AG

Order 1 to receive a card of five. Round glass fuses  
Gold plated Suits FH512

Current	Code
10A	MFL10
20A	MFL20
30A	MFL30
40A	MFL40
50A	MFL50
60A	MFL60

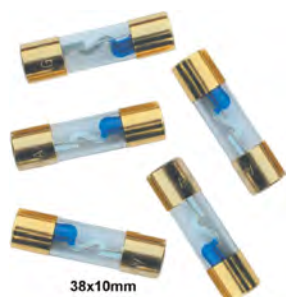

### GBC FUSES

#### TORPEDO FUSES

Order 1 to receive ONE.  
Available in boxes of 5.  
As used in earlier cars  
European & Australian  
Approx. 25mm x 6mm

Current	Code
5A	GBC5
8A	GBC8
16A	GBC16
20A	GBC20
25A	GBC25
30A	GBC35

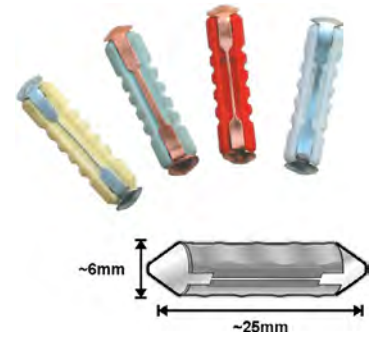

### FUSE PULLER TOOLS

For our complete range of Fuses of all sizes!  
See our Component Section Two SFE CEB 2AG MGC 3AG & More!

#### FUSE PULLER

ATC & Glass fuses, etc.  
Remove and insert with ease of grip.

Code  
FRT3

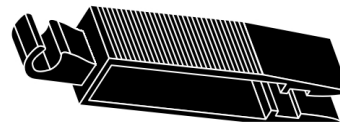

Heavy Duty  
Code  
YF6254



### RESETTABLE CIRCUIT BREAKERS

#### BAKELITE FLAT MOUNT

High temp. Fuse with reset. 4mm heavy  
duty screw terminals With trigger test  
button. Use as a 140A power switch.

Current	Code
70A	CRB70
100A	CRB100
140A	CRB140



#### CLEAR BOOT

Protective insulator

Code  
BSC100

### RESETTABLE CIRCUIT BREAKER 60A

#### 60A 4/8AWG INLINE

Weather resistant design for  
under bonnet install Attractive  
clear & black with gold plated  
terminals for professional install  
Accepts 4 or 8 AWG Cable Gold  
screw terminals with grommets  
for moisture & dust Mounting  
flange. Test button.

Code  
AP484

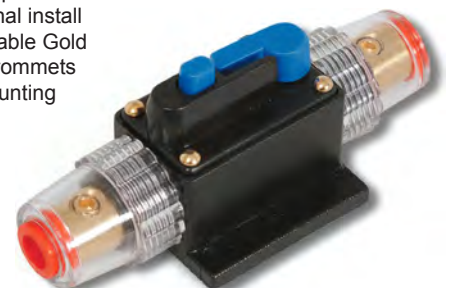



# 18 CAR AUDIO ACCESSORIES

18 CAR AUDIO ACCESSORIES

## → Distribution Blocks

### 0 AWG CABLE SPLITTER WITH METER

1x0AWG → 2x4AWG POWER

Split your power to two amps  
monitor your application  
Voltage & Current Display  
Gold plated hex terminals  
Smoked perspex cover  
Screw mount base black  
Blue LED digital meter of  
Voltage and Current 200A  
Smart & attractive



Code  
APD4025

### 4 AWG POWER DISTRIBUTION BLOCKS

1x4AWG → 4x8AWG

Gold plated block encapsulated in  
a clear mounting bracket Allen key  
cable locks

#### SINGLE BLOCK

Code  
PDB520

#### ABOVE DUAL

Code  
PDB522

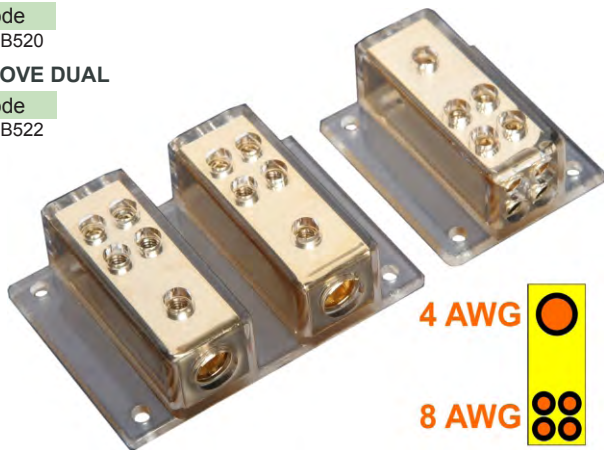

4 AWG

8 AWG

## CABLE JOINERS

Gold plated  
Heavy Duty With  
clear insulator.  
Grub screw lock

8AWG 5mm I/D

Code  
PCJ508

4AWG 7mm I/D

Code  
PCJ504



## LOOKING FOR LAMPS?

MORE AVAILABLE

We stock a  
comprehensive range of  
most glass & plastic fuse  
types and...

INDICATOR LAMPS

Dial lamps and other  
indicators, etc.



Please Enquire. See Section 02 COMPONENTS.

## → Battery Terminal and Accessories

### GOLD PLATED BATTERY CLAMPS

POSITIVE TERMINAL  
With 2x8AWG clamps

Code  
GBT110

NEGATIVE TERMINAL  
With 2x8AWG clamps

Code  
GBT112

CLEAR BOOT

Protective insulator

Code  
BSC110



### GOLD PLATED MULTI BATTERY TERMINALS

2x 4AWG & 2x 8AWG

Allen Key screws.

Type Code  
POS GBT120  
NEG GBT122

CLEAR BOOT

Protective insulator

Code  
BSC120



### GOLD PLATED MULTI BATTERY TERMINALS

1x 4AWG & 2x8AWG

Allen Key screws. 1x  
screw terminal. Stamped  
indicator Shows polarity:

Type Code  
POS GBT130  
NEG GBT132



### 8mm POWER RING TERMINALS

Gold plated High current  
Suits 8mm Post terminals

AWG Code  
0 AWG PRT500  
2 AWG PRT502  
4 AWG PRT504  
8 AWG PRT508

CLEAR BOOT

Protective insulator

Code  
BSC130



### AWG CABLE ADAPTORS

Adapts assorted sizes  
Platinum plated steel  
Gold plated hex screw  
Power or speaker

0/2/8AWG → 4AWG SHAFT

Code  
PS25

4AWG → 8AWG SHAFT

Code  
PS26







→ Interconnects & Wire

↓ Crimp Terminals - Gold Plated

**GOLD PLATED SPADE CONNECTORS**

BULK Sold individually Red or Black

14→12AWG (3.5mm) → 4mm SPADE

Colour	Code
Red	TS300
Black	TS301



14→12AWG (3.5mm) → 6.3mm SPADE

Colour	Code
Red	TS310
Black	TS311



**GOLD PLATED SPADE TERMINATORS 4mm**

BULK Sold individually, Red or Black

14→12 AWG (3.5mm)

Colour	Code
Red	TS200
Black	TS201



10→8 AWG (5mm)

Colour	Code
Red	TS500
Black	TS501



**GOLD SPADE TERMINATORS R/A 4mm**

BULK Sold individually, Red or Black.

14→12 AWG (3.5mm)

Colour	Code
Red	TS250
Black	TS251



10→8 AWG (5mm)

Colour	Code
Red	TS550
Black	TS551



→ Banana Plugs

**GOLD PLATED BANANA PLUGS**

**INSULATED BOOT TYPES**

Screw cable retainers Plastic coloured boot Piggy back extra plugs Sold in BULK individually

10 AWG 2.5mm (3mmØ+ Jacket)

Colour	Code
Red	P752RD
Black	P752BK



8 AWG 3.3mm (6mmØ Jacket)

Colour	Code
Red	P756
Black	P758



**GOLD PLATED BANANA PLUGS**

6 AWG 4.0mm (8mmØ Jacket)

Gold plated. Colour bands Order one to receive TWO

Colour	Code
Red	P760
Black	P761



4 AWG 5.0mm (8mmØ Jacket)

Colour	Code
Red	P769
Black	P768



4 AWG 5.4mm (Side Entry)

Colour	Code
Red	P765
Black	P766



↓ Crimp Terminals - Gold Plated

**GOLD PLATED RING TERMINALS**

**HEAVY DUTY CRIMP TYPE**

8 AWG → RING 5.0mm I/D

Colour	Code
Red	TR85
Black	TR86



8 AWG → RING 8.0mm I/D

Colour	Code
Red	TR80
Black	TR81



4 AWG → RING 8.0mm I/D

Colour	Code
Red	TR40
Black	TR41



↓ Alligator Clips

**ALLIGATOR CLIPS MINI**

Vanadium chrome steel Coloured rubber boot 3 piece Mini Jaw sprung  
10A 8mm Jaw 8mm Wide

Colour	Code
Red	LGC006R
Black	LGC006B



20A 10mm Jaw 10mm Wide

Colour	Code
Red	LGC007R
Black	LGC007B



**ALLIGATOR CLIPS STANDARD**

Vanadium chrome steel Coloured rubber boot Jaw sprung. Standard.

15A 20mm Jaw 10mm Wide

Colour	Code
Red	LGC015R
Black	LGC015B



30A 20mm Jaw 12mm Wide

Colour	Code
Red	LGC016R
Black	LGC016B



**ALLIGATOR CLIP HEAVY-DUTY**

200A

25mm Jaw 25mm Wide Heavy Duty type Full hand grip

Colour	Code
Red	LGC022R
Black	LGC022B



600A

35mm Jaw 20mm Wide Super Heavy Duty Full hand grip

Colour	Code
Red	LGC023R
Black	LGC023B



**MORE AVAILABLE**

**TOO MANY TO LIST HERE!**

Many more available... For our full range of Connectors Plugs Sockets Please enquire Section Seven Connectors Section Thirteen Cable Section Eight Prepared Leads Section Fourteen Tools





# 18 CAR AUDIO ACCESSORIES

## ↓ Automotive Switches

### PREMIUM AUTOMOTIVE SWITCH

#### 20A 12V ROCKER SWITCH

Carling Technologies Weather resistant High temperature Heavy duty long life 20A Low voltage (12V) Affirmative action Quality feel & touch Illumination option All 1/4" Spade connectors Requires mounting gasket

Code  
SW-GASKET

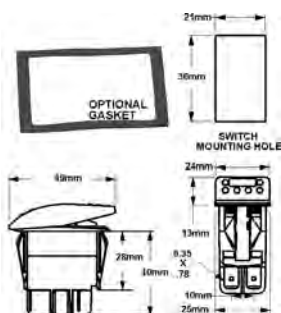

### NON-ILLUMINATED

#### TOGGLE

Pole	Type	Code
SPST	ON/OFF	SW-V1BA
DPST	ON/OFF	SW-VABA
SPDT	ON/ON	SW-V4BA
SPDT	ON/OFF/ON	SW-V6BA
DPDT	DPDT	SW-VJBA



#### MOMENTARY

Pole	Type	Code
SPST	SPST	SW-V2BA
SPDT	SPDT	SW-V8BA
DPDT	DPDT	SW-VLBA
GASKET		SW-GASKET

### ILLUMINATED RED-BAR

#### TOGGLE

Push on. Lamp indicator. 12V Attractive Red-Bar style.

Pole	Type	Code
SPST	ON/OFF	SW-V1DAB1
DPST	ON/OFF	SW-VADAB

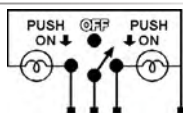

#### DUAL BAR TYPE

Toggle. Centre OFF. Two lamps. 12V

Pole	Type	Code
SPDT	SPDT	SW-V6DAD
GASKET		SW-GASKET

### ILLUMINATED RED BEZEL

#### TOGGLE

Push on toggle actuator. RED Lamp indicator. 12V. Attractive easy grip style.

Pole	Type	Code
SPST	SPST	SW-V1DAB2
GASKET		SW-GASKET

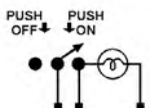

### ILLUMINATED GREEN BEZEL

#### TOGGLE

Push on. Lamp indicator. 12V White opaque square window Independent 12V LED Wiring. Only the one indicator in DPDT.

Pole	Type	Code
DPST	DPST	SW-VAD1
DPDT	DPDT	SW-VJD1



#### MOMENTARY TYPE

Pole	Type	Code
DPST	DPST	SW-VBD1
DPDT	DPDT	SW-VLD1
GASKET		SW-GASKET



## → 12VDC Plugs & Sockets

### ACCESSORIES PLUG

#### STANDARD

Code  
P801



#### FUSED

Code  
P810



### CAR ACCESSORIES LEAD

Car Accessories Plug  
3.5mm X2 cable Bare end  
Fused

Amps	Length	Code
8A	5M	DCL50
3A	2M	DCL18



### ACCESSORIES JACK

Metal barrel High temp for Cigarette or Accessories

Code  
J800



### INLINE SOCKET

Black & Insulated  
NOT A LIGHTER TYPE

Code  
J802



### ACCESSORIES UNDER-DASH

Two sockets and bracket.  
20A fuse 3AG inline wires.

Code  
DPV63



### MERIT AUTOMOTIVE

12Vdc European Accessories Plug System.

Type Code  
Plug MER101

Type Code  
Inline MER110

Type Code  
Socket MER112

Type Code  
Dual MER102

Type Code  
Adaptor MER201





## ↓ Cross-Over Components

### 100V NON-POLARISED ELECTROLYTIC

General purpose capacitors  
Non-polarised (AC) for audio  
100V Suits crossovers, etc.

Value	Code
0.47µF	.47NP100
1µF	1NP100
2.2µF	2.2NP100
3.3µF	3.3NP100
4.7µF	4.7NP100
10µF	10NP100
22µF	22NP100
33µF	33NP100
47µF	47NP100
100µF	100NP100



### 100V NON-POLARISED AXIAL

#### AXIAL WIRED CAPACITORS

General purpose capacitors Non-polarised (AC) for audio 100V  
Suits crossovers, etc.

Value	Code	Value	Code
1µF	1RY100	33µF	33RY100
2.2µF	2.2RY100	47µF	47RY100
3.3µF	3.3RY100	68µF	68RY100
4.7µF	4.7RY100	100µF	100RY100
6.8µF	6.8RY100	150µF	150RY100
10µF	10RY100	220µF	220RY100
15µF	15RY100	330µF	330RY100
22µF	22RY100	470µF	470RY100



### SOLENE METALLIZED POLY' AUDIO CAPS

Premium grade made in France. Beautiful sounding Crossover, etc.  
400Vdc 250Vac High power.

Value	Code	Value	Code
0.15µF	SCR.15	7.5µF	SCR7.5
0.27µF	SCR.27	8.2µF	SCR8.2
1µF	SCR1	10µF	SCR10
1.6µF	SCR1.6	12µF	SCR12
2.2µF	SCR2.2	15µF	SCR15
3.0µF	SCR3.0	18µF	SCR18
3.3µF	SCR3.3	20µF	SCR20
3.9µF	SCR3.9	27µF	SCR27
4.7µF	SCR4.7	33µF	SCR33
5.6µF	SCR5.6	47µF	SCR47
6.8µF	SCR6.8		

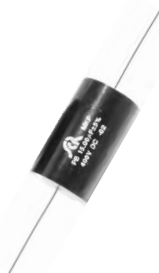

<http://www.solen.ca/caps/mkp3.htm>

### 250V METALLIZED POLYPROPYLENE FILM

Excellent general purpose AC Audio crossover capacitors Non-Inductive, wrap and fill with polyester tape and epoxy resin.

Value	Code
10nF	PMT.01
15nF	PMT.015
22nF	PMT.022
33nF	PMT.033
47nF	PMT.047
68nF	PMT.068
100nF	PMT.1
150nF	PMT.15
220nF	PMT.22
330nF	PMT.33
470nF	PMT.47
680nF	PMT.68
820nF	PMT.82
1µF	PMT1
1.5µF	PMT1.5
2.2µF	PMT2.2
2.7µF	PMT2.7
3.3µF	PMT3.3
3.9µF	PMT3.9
4.7µF	PMT4.7
5.6µF	PMT5.6
6.8µF	PMT6.8
8.2µF	PMT8.2
10µF	PMT10
12µF	PMT12
15µF	PMT15
20µF	PMT20



### 6dB CROSSOVER VALUES

Passive component values for building your own crossover Courtesy Stones Sound Studio

	L-4Ω	C-4Ω
130Hz	4.7mH	330µF
200Hz	3.3mH	220µF
260Hz	2.2mH	150µF
400Hz	1.6mH	100µF
600Hz	1.0mH	68µF
800Hz	.82mH	47µF
1000Hz	.62mH	39µF
1200Hz	.51mH	33µF
1800Hz	.33mH	22µF
4000Hz	.16mH	10µF

Mathematically calculated assuming non reactive load

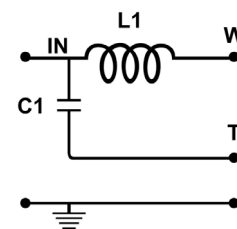

## ↓ Cross-Over Components

### TAG STRIPS

Fibreglass with metal solder tags for making your own small circuits Crossovers, car mods, etc. Screw fixing.

#### 6 WAY (60mm)

Code  
TAG6

#### 8 WAY (80mm)

Code  
TAG8



### NON-INDUCTIVE RESISTORS

Wire wound Ceramic. HQ.  
0.22Ω g 100Ω in Popular Values.  
Values Available (Ohm):

5W x = Value in Ω

Code\*  
5NLRxx

10W x = Value in Ω

Code\*  
10NLRxx

.22 .27 .33 .39 .47 .51 .56 .68 .82 1.0 1.5 1.8 2.2 2.7 3.3  
3.9 4.7 6.8 8.2 10 12 15 18 22 27 33 39 47 51 56 68 82 100Wire  
wound Ceramic. HQ. 0.22Ω g 100Ω in Popular Values.

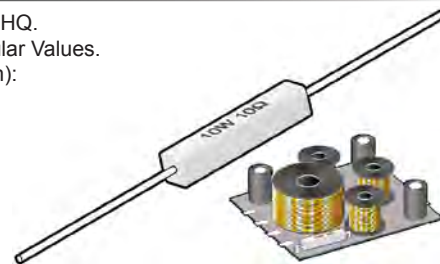

### INDUCTORS 1mm(18AWG) X-OVER

Premium quality AIR-CORE ~100Wrms\*+

Value	Ω	Size	Code
0.03mH	0.05Ω	15x30Ø mm	XLA0.03
0.05mH	0.1Ω	50x20Ø mm	XLA0.05
0.08mH	0.05Ω	15x30Ø mm	XLA0.08
0.10mH	0.1Ω	50x20Ø mm	XLA0.1
0.12mH	0.1Ω	50x20Ø mm	XLA0.12
0.15mH	0.2Ω	50x20Ø mm	XLA0.15
0.18mH	0.2Ω	50x20Ø mm	XLA0.18
0.22mH	0.2Ω	50x20Ø mm	XLA0.22
0.33mH	0.3Ω	50x20Ø mm	XLA0.33
0.39mH	0.3Ω	50x20Ø mm	XLA0.39
0.47mH	0.3Ω	50x20Ø mm	XLA0.47
0.56mH	0.4Ω	50x20Ø mm	XLA0.56
0.68mH	0.5Ω	50x20Ø mm	XLA0.68
0.82mH	0.5Ω	50x30Ø mm	XLA0.82
1.0mH	0.6Ω	50x30Ø mm	XLA1
1.2mH	0.7Ω	50x30Ø mm	XLA1.2
1.5mH	0.8Ω	50x30Ø mm	XLA1.5
1.8mH	0.8Ω	50x30Ø mm	XLA1.8
2.2mH	0.8Ω	70x35Ø mm	XLA2.2
2.7mH	0.9Ω	70x35Ø mm	XLA2.7
3.0mH	0.9Ω	70x35Ø mm	XLA3
3.3mH	1.2Ω	70x35Ø mm	XLA3.3
3.9mH	1.4Ω	70x35Ø mm	XLA3.9
4.7mH	1.4Ω	70x35Ø mm	XLA4.7
5.6mH	1.4Ω	70x35Ø mm	XLA5.6
6.8mH	1.5Ω	70x35Ø mm	XLA6.8
8.2mH	1.8Ω	70x35Ø mm	XLA8.2
10 mH	2.0Ω	90x45Ø mm	XLA10



\*F Dynamics make it impossible to specify a power rating  
(At least 100Wrms)



# 18 CAR AUDIO ACCESSORIES

## → Installation & Accessories

### ↓ Installation Misc

#### FIXING BITS

##### SCREW GAUGE

Rough guide only.

1.59mm = 1/16"

1.98mm = 5/64"

2.38mm = 5/32"

3.18mm = 1/8"

Nominal Diameter Gauge	Clearance mm	Pilot Hole Hole	Wood	Metal
6	3.45	3.57	1.59	2.38
7	3.81	3.97	1.59	2.38
8	4.17	4.37	1.98	3.18
10	4.88	5.16	1.98	3.18

**Section 14 Tools**  
For More Styles



#### CHIPBOARD WOOD SCREWS

##### BOX OF 100x SCREWS

Order one to receive a box Blister pack of 100 pieces Zinc steel self-tappers course for medium density particle board & soft woods.

Size	Code
4.0x13mm	STC4013
4.0x19mm	STC4019
4.0 x 25mm	STC4025
4.0 x 32mm	STC4032
4.5 x 45mm	STC4545



#### MDF & WOOD SCREWS

##### BAG OF 100x SCREWS

Bugle-head Self-tappers Dual-start Fine-threaded High-density particle board or any type of solid wood

Size	Code
7G x 20mm	SBHP720
7G x 25mm	SBHP725
7G x 30mm	SBHP730
7G x 35mm	SBHP735
7G x 50mm	SBHP750
8G x 50mm	SBHP850
8G x 63mm	SBHP863



#### WOOD & METAL SCREWS

##### BAG OF 20x SCREWS

Hex-head 1/4" (6.35mm) Philips head screws Single-start Coarse-threaded Pilot hole type screws for medium and high density MDF Black anodised finish. Supplied 20 per packet

Size	Code
8G x 20mm	STS7B
10G x 25mm	STS8B



#### WOOD & METAL SCREWS

##### BAG OF 100x SCREWS

Washer-head Needle Points Hex-head 1/4" (6.35mm) screws Dual-start Coarse-threaded Pilot hole type screws for some woods & metals, etc. Zinc metal (yellow) finish.

Size	Code
8G x 12mm	SBTN812
8G x 25mm	SBTN825
8G x 32mm	SBTN832



#### 1400 SCREW PACK

##### 100X 14 SCREW TYPES

Attache case with removable compartments each containing popular self tapping screws.

Button Tek's 8G x 12/25/32mm Pan Head 6G x 20/30/50mm Bugle Head 7G x 20/25/30/45mm Bugle Head 8G x 63mm Washer Head 8G x 15/25/30mm Box 420x340x60mm

Code  
SCR14



#### METAL SCREWS

##### BAG OF 100x SCREWS

Pan-head Needle Point Dual-start Fine-threaded Pilot hole type screws for High-density particle board Metals & some woods, etc. Zinc metal (yellow) finish. Cabac quality products

Size	Code
6G x 20mm	SPNP620
6G x 30mm	SPNP630
6G x 50mm	SPNP650



#### METAL SCREWS

##### BOX OF 100x SCREWS

Pan-head Needle Point Single-start Fine-threaded Pilot hole type screws for High-density particle board Metals & some woods, etc. Black oxide finish.

Size	Code
3.9x13mm	STP3913
3.9x19mm	STP3919
3.9x25mm	STP3925
4.2x38mm	STP4238



#### METAL SCREWS

##### BOX OF 100 SCREWS

Button Head Self-Drill Metal work screws Coarse Threaded Zinc yellow

Size	Code
3.9x13mm	STB3913
3.9x25mm	STB3925
4.2x32mm	STB4232



#### METAL SELF-DRILL SCREWS

##### BAG OF 100 SCREWS

Wafer Head Self-Drill Metal work screws Fine Threaded Zinc yellow

Size	Code
10G x 22mm	SWTS1022
10G x 30mm	SWTS1030



MORE STYLES AVAILABLE

See Section 14 TOOLS & TEST EQUIPMENT Tools...



## → Installation & Accessories

### NUT & BOLT KITS

#### BAGS OF NUT/BOLT/WASHERS

Pan head Posi Bolt x50 Nut x50 & Washer x50 Black oxide finish Metric threaded set

**M3 [3mm Hole]**

Code  
M350KB

**M4 [4mm Hole]**

Code  
M450KB



### NUTS & BOLTS

Stainless Steel. X10

#### M3 BOLTS

Code  
YC85

#### M3 NUTS

Code  
YC81

#### M3 WASHERS

Code  
YC83

#### M3 SPRING WASHERS

Code  
YC84



## ↓ Pop Rivets & Tool

### POP RIVETS

4mm x 10mm [100pcs]

Order one to receive a bag 100 pieces supplied

Code  
SCPR1



#### HAND TOOL GRIPWELL

Heavy duty 260mm metal Rivet gun with bonus 60 pieces of assorted rivets. Toolbox packaged.

Code  
PA26448



## ↓ Cable Management

### CABLE STAYS

#### SQUARE WIRE HOLDERS

Snap-fits 4mm holes Snap-locks cables for neat and tidy work. Order 1 to receive 100.

**16x11mm**

Code  
WH1

**25x11mm**

Code  
WH2



### CABLE STAND-OFFS

#### CABLE TWIST & HOLDER

Snap-fits 4mm holes Twists to hold cables with stand-off arm. Order 1 to receive 100.

**11mmØ**

Code  
WTL11

**17mmØ**

Code  
WTL17



## ↓ Tapes

### DOUBLE-SIDED TAPE

Premium grade adhesive tapes. Very thin Tissue acrylic leaves no gap between secured objects. White. \*Are cloth reinforced.

Cloth	Width	Length	Code
	12mm	33M	DST5238
	24mm	33M	DST5242
*Y	24mm	25M	DST4506
*Y	48mm	25M	DST4510



### DOUBLE-SIDED FOAM TAPE

Premium grade adhesive rolls.

Colour	Thick	Width	Length	Code
Black	1mm	12mm	10M	DST4884
White	1mm	12mm	50M	DST4945
Black	1mm	18mm	5M	IT50
White	1mm	18mm	50M	DST4946



## VELCRO - MORE IN SECTION 13...

### GENUINE VELCRO WRAP

We stock a comprehensive range of genuine Vecro brand items. See Section 13 Cables & Accessories.



#### STICK-ON BLACK 25x50mm

Code  
FT25558

#### ROUGH SURFACE GREY 25x100mm

Code  
FT25546

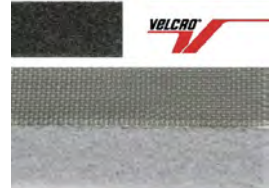

#### STICK-ON DOTS BLACK 13mmØ

Code  
FT25568



### MASKING TAPE

#### PREMIUM GRADE

Non-tear quality.

**24mm x 50M**

Length Code  
50M MSK2002

**48mm x 50M**

Length Code  
50M MSK2004



### GAFFA TAPE

#### GENUINE NASHUA 357

Made in USA. Best available. Cloth re-inforced poly tape.

**48mm x 40M ROLLS**

Colour	Code
Black	GAF357BK
Silver	GAF357SL
White	GAF357WH

**48mm x 40M REPLICA**

Colour Code  
Black GAF399

**Black/Yellow striped 25M**

Code  
HCT3220





# 18 CAR AUDIO ACCESSORIES

18 CAR AUDIO ACCESSORIES

## ↓ HeatShrink

### HEAT SHRINK KIT

A selection of seven popular sizes. 7 Pieces of 1.2 Metre lengths XLP Series. XLP1.5BK, XLP2.5BK, XLP3BK, XLP5BK, XLP7BK, XLP10BK, XLP13BK

Code  
HSK1BK



### HEAT SHRINK TUBING

Flexible heat shrinkable tubing Flame retardant, good resistance to most fluids and solvents, etc. High dielectric and tensile strength. Excellent for electrical identification, insulation, strain relief, cable bonding. 600V 50% shrink ratio at 90 → 120°C.

BEFORE DiamØ=Code(mm) - AFTER DiamØ=50%

	Black	Yellow	Red	White	Green	Blue
for 1.2M	CB102-1.0BK	CB102-1.0YL	CB102-1.0RD	CB102-1.0WH	CB102-1.0GN	CB102-1.0BU
for 1.2M	CB102-2.0BK	CB102-2.0YL	CB102-2.0RD	CB102-2.0WH	CB102-2.0GN	CB102-2.0BU
for 1.2M	CB102-2.5BK	CB102-2.5YL	CB102-2.5RD	CB102-2.5WH	CB102-2.5GN	CB102-2.5BU
for 1.2M	CB102-3.0BK	CB102-3.0YL	CB102-3.0RD	CB102-3.0WH	CB102-3.0GN	CB102-3.0BU
for 1.2M	CB102-4.5BK	CB102-4.5YL	CB102-4.5RD	CB102-4.5WH	CB102-4.5GN	CB102-4.5BU
for 1.2M	CB102-5.0BK	CB102-5.0YL	CB102-5.0RD	CB102-5.0WH	CB102-5.0GN	CB102-5.0BU
for 1.2M	CB102-6.5BK	CB102-6.5YL	CB102-6.5RD	CB102-6.5WH	CB102-6.5GN	CB102-6.5BU
for 1.2M	CB102-7.0BK	CB102-7.0YL	CB102-7.0RD	CB102-7.0WH	CB102-7.0GN	CB102-7.0BU
for 1.2M	CB102-10.0BK	CB102-10.0YL	CB102-10.0RD	CB102-10.0WH	CB102-10.0GN	CB102-10.0BU
for 1.2M	CB102-13.0BK	CB102-13.0YL	CB102-13.0RD	CB102-13.0WH	CB102-13.0GN	CB102-13.0BU
for 1.2M	CB102-20.0BK	CB102-20.0YL	CB102-20.0RD	CB102-20.0WH	CB102-20.0GN	CB102-20.0BU
for 1.2M	CB102-25.0BK	CB102-25.0YL	CB102-25.0RD	CB102-25.0WH	CB102-25.0GN	CB102-25.0BU



## → Cable Management

### CABLE TIES [BAGS OF 100]

Order ONE bag to receive 100 pieces.

Colour	Size	Code
White	100mm x 2.5mm	NCT120
Black	100mm x 2.5mm	NCT121
White	142mm x 3.6mm	NCT130
Black	142mm x 3.6mm	NCT131
White*	156mm x 3.6mm	NCT140
Black*	156mm x 3.6mm	NCT141
White	203mm x 3.6mm	NCT150
Black	203mm x 3.6mm	NCT151
White	292mm x 4.8mm	NCT160
Black	292mm x 4.8mm	NCT161



### SPIRAL WIRE WRAP

Winds around to secure messy wiring, expands x5.

#### 10M x 5mmØ

Colour	Code
Black	SPWR10BK
White	SPWR10WH

#### 10M x 20mmØ

Colour	Code
Black	SPRL15B
White	SPRL15W

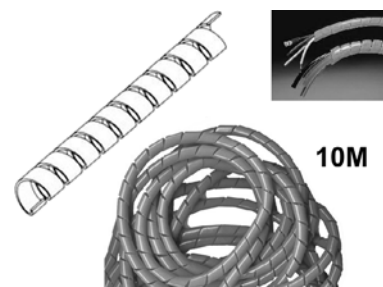

### CABLE TIES IN A KIT

#### 100 PIECES ASSORTED

Nylon. Assorted colours. Supplied in a plastic jar.  
50x 2.5 x 100mm  
25x 2.5 x 200mm  
25x Stick-N-Hold

Code  
NCT500



### EASY-WRAP CABLE TIDY

Includes a handy applicator making assembly quick n' easy!

#### 20mm x 1.5M

Code  
EW20BK

#### 16mm x 1.5M

Code  
EW16BK



### SPIRAL WIRE WRAP

Winds around messy cabling and protects. Aerpro. BLACK Length is approx. 10M

Diam.	Code
4-50mm	SLT4
7.5-60mm	SLT75
15-100mm	SLT15



### SPLIT WIRE WRAP REINFORCED

#### AUTOMOTIVE LOOM TYPE

Split down the middle for inserting multiple wiring. Protective ribbed casing, like a vacuum hose, so will bend for easy installation. Diameter does not stretch. Flexible UV Black ABS Plastic. 10 Metre lengths.

Size	Code
10mm x 10M	SLT10
16mm x 10M	SLT16
7mm x 10M	SLT7

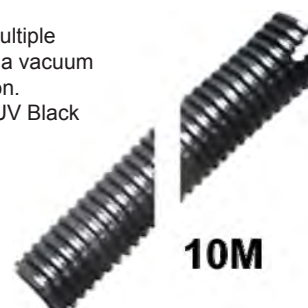



## THE HERBIE CLIP™

When it comes to hose clamps, nothing beats the reliability and speed of fitting the Herbie Clip. Available in a comprehensive range of sizes, the Herbie Clip is a one piece nylon hose clamp that uses a proven double row of interlocking teeth to produce an extremely secure and reliable fit. Near perfect circle fitting for a better, tighter seal as a hose clamp. Quality molded from Nylon 6.6 carbon based polymer for extra long life. The Herbie Clip is totally resistant to any atmospheric conditions. Impervious to a majority of chemicals and fuels, salt water, etc. Excellent solution for long term reliability in hostile environments. The result is an extremely strong clamp guaranteed to 200psi ! A popular solution in many industries worldwide for eighteen years now.

Unlike any other hose fastener available, the Herbie Clip with its patented dual interlocking tooth design allows the fastest and easiest application with incredible reliability, durability and functionality. The clip is Heat, Cold and UV stabilised. It will not rust or corrode. It won't react with contaminants nor damage or react with the application. An impressive solution for many situations offering many advantages. The clip is an economical solution as it is cheaper than metal strips and the ease and speed of application saves considerable time and money. Specific hand tools for reliable and consistent operation is available, however, the Herbie Clip can also be fastened by a pair of Multi-Grips. Easy removal for unlimited re-use of the Herbie Clip and easy re-work.

### WHY USE THE HERBIE CLIP™?

Patented double jaw design for 200psi strength Heat & UV stabilised. Impervious to contaminants Quicker & easier to fit or adjust than metal clips Improved safety as no sharp edges to cut operator Minimal leak path as clamps to a near perfect circle Fitting & Removal tools available for production use Carbon based polymer will never rust or corrode Non conductive so more suitable for cable fixing No electrolytic reactions with other metals, etc. 18 years of field use in many fields & applications Simplistic, cost effective.

Very Strong and Reliable  
Very Fast Application  
Nylon Hose Fastener  
18 Years Strong

**HERBIE CLIP™**

The Double Grip Hose Clip  
Available in 5mm to 105mm

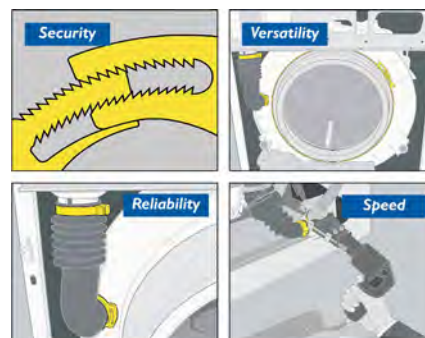

THE SMART SOLUTION FOR MANY APPLICATIONS:



## HERBIE CLIP™ TOOLS

You can use any Multi-Grip type hand tool. For a consistent setting, use the tools below.

### MANUAL FITTING TOOL

Clamps to the same number of teeth.

Code  
HCT3000

### CLIP REMOVAL TOOL

Twist to remove the Herbie Clip.

Code  
HCT4000



## HERBIE CLIP™ CODES LISTING

A min	B max	C width	D	E	F	G	Code
5.60	6.50	4.2	1.4	8.3	17.5	0.53	HC0642
6.50	7.90	4.5	1.6	9.9	20.9	0.82	HC0745
7.90	9.20	4.4	1.6	9.3	20.7	0.90	HC0844
9.20	10.3	4.5	1.7	10.9	22.2	1.11	HC1045
10.2	11.8	5.8	1.7	12.2	27.9	1.73	HC1158
11.1	12.9	6.1	1.7	12.3	28.7	1.94	HC1261
12.0	13.8	6.1	1.7	12.9	28.9	1.95	HC1361
13.5	15.1	7.1	2.0	13.6	32.7	3.26	HC1471
15.0	17.1	7.1	2.0	12.9	34.8	3.18	HC1671
16.9	19.1	6.9	2.1	12.5	32.4	2.00	HC1869
18.1	20.6	7.1	2.1	12.7	35.7	3.23	HC1971
20.3	23.0	6.4	2.1	14.2	39.0	1.08	HC2264
22.2	24.9	7.0	2.0	13.0	37.0	3.61	HC2470
24.5	27.6	7.1	2.1	12.5	37.3	3.43	HC2671
26.5	29.5	7.4	2.2	13.4	40.0	4.80	HC2874
28.8	32.2	9.0	2.0	13.4	42.0	5.60	HC3090
32.0	34.8	9.1	1.9	13.8	40.0	6.15	HC3391
34.3	37.9	8.9	2.1	13.5	42.0	7.05	HC3689
37.0	40.4	8.9	2.1	13.3	42.2	6.48	HC3989
40.1	44.2	9.0	2.2	13.4	42.2	6.60	HC4290
43.2	46.2	8.9	2.1	12.8	42.5	6.81	HC4589
45.8	50.4	9.0	2.0	13.9	45.0	7.31	HC4790
48.5	53.8	9.0	2.1	14.4	48.0	8.17	HC5190
53.0	57.0	9.0	2.1	14.7	49.0	7.61	HC5590
54.9	60.1	9.3	2.3	16.0	53.4	9.95	HC5793
59.0	64.7	17.0	9.3	10.7	9.3	7.93	HC6393



Prices PER CLIP. For larger sizes & quantities, Please enquire



# 18 CAR AUDIO ACCESSORIES

18 CAR AUDIO ACCESSORIES

## → Tools

### SOCKET & WRENCH SET

#### 29 PIECE CHROME-VANADIUM

Compact cased tool kit with 150mm Ratchet Mini Socket Set Made from quality components High grade Chrome-Vanadium Hand driver and uni-joint T-Bar torque driver 12x Hex Sockets 4→13mm 12x Screw driver bits

Code  
GTK231



### RADIO SERVICE TOOL KIT

#### REMOVAL TOOLS

Unique hand tools required to remove todays car audio items Includes the 5 TORX bits GM Code retriever Chrysler radio remover Ford radio remover clips Antenna multi-wrench packaged in a tool box.

Code  
HTJ5800



### ULTIMATE SCREW DRIVER SET

#### 42 PIECE SOLUTION

Includes a Flexi-Shaft for hard to reach areas Jeweller screw drivers Premium grade vanadium strengthened with soft hand easy grip handles and a set of 25 piece rare bits set for a complete driver solution in a compact carry case.

Code  
GSD306



### FORD RADIO REMOVAL TOOLS

#### TWIN BULLET CLASPS

As required for removing the radio from the dash.

Code  
HTJ7575



### ELECTRONIC TOOL KIT

#### 25 PIECE HANDY TOOL CASE

An assortment of popular tools as used by the electronic tradesmen conveniently packaged in a zip-up wallet case for the mobile installer. All tools are premium grade long-life includes a 240Vac Soldering Iron, Solder, sucker, braid, paste, Cutters, pliers, nippers, drivers, Files, scribe & cleaning tools. Case is 300x200x50mm

Code  
GTK030B



### MERCEDES & BMW TOOL SET

#### IGNITION & RADIO

Kit contains: Radio removal tools Instrument cluster hooks Ignition lock removal

Code  
HTJ1135



### ADJUSTABLE WRENCH

#### 150mm / 20mm

Drop-Forged steel chrome Rust resistant. Quality. Adjustable jaw to 20mm

Code  
STP710



#### 205mm / 30mm

Drop-forged steel chrome wrapped in non-slip grip Satin finish quality tool

Code  
HT17187

### ANTENNA NUT SET

#### 5 PIECE KIT

Vanadium steel sockets Professional solutions Suits most car antennae HEX nut standard socket 20mm Dual/Tri/Quad 25mm and 30mm set.

Code  
AT300A



### MORE TOOLS

#### PLEASE ENQUIRE

Section 14 TOOLS & TEST EQUIPMENT holds an extensive range of hand tools for the tradesman to the hobbyist with professional grade and also well priced options.



### ANTENNA WRENCH

#### STAMPED STEEL MULTI

Fits many of todays car antennas for removal. 20mm to 30mm.

Code  
HTJ5700

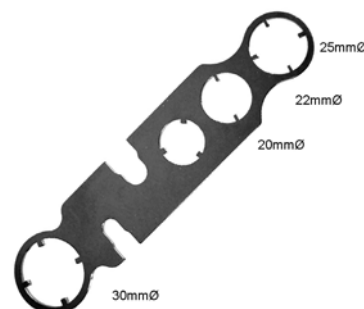

### SECTION 14 TOOLS & TEST EQUIPMENT





## 12V WORK LIGHT

### 12V FLUORO TUBE 13W

Bright fluorescent double folded lamp with hook for under bonnet, camp sites, etc. 12Vdc. 1A. Includes 3.0M cable to accessories 12V plug. 370mm Long.



Code  
TT1104

## LED WORK LIGHT

### 12V RECHARGEABLE

26X Super Bright LEDs. Charge from mains or Car 12V. 435mm in length. Includes 12Vdc & 240Vac chargers.

Code  
WL3



## 12V WARNING LAMP

### AMBER EMERGENCY STROBE

Excellent solution for safety and emergencies. 12Vdc accessories plug. Curly cord 1Mg2M long. Felt padded magnetic base for bonnet or hood placement. Rotating globe mirror. 120mm Base 145mm High Amber in colour

Code  
TT1100



## 12V IMPACT WRENCH

### ELECTRONIC SOCKET KIT

This is the easiest way to change tyres. Simply plug the cord into your vehicle's accessories socket or with the adapter, attach directly to your car's battery. It provides up to 100 watts of impact power so you can loosen or tighten wheel nuts with minimal effort in seconds. It has a built-in aiming light to assist you to see at night too. Conveniently packaged in a tool case. Stores easily in the boot for that un-anticipated emergency situation. Save effort and energy for the garage.

### KIT INCLUDES:

Extra long power cable 3.9M Battery adapter with alligator clips Hub cap remover LEVER 4 socket sizes Sturdy ABS plastic case.

Code  
TT607



**IMPACT WRENCH**

### UP DATE YOUR TYRE-IRON



## 12V AIR COMPRESSOR

### 12V 250PSI

250 PSI high pressure air compressor Comes with nozzle adapters & sports needle. Built-in handy pressure gauge. 2.2M power cord with accessories plug. Excellent multi-purpose electronic compressor for the garage or boot. Size 100x260x160mm inclusive. TYRES, SPORTS & MATTRESS.

Code  
MCP250



## 12V AIR COMPRESSOR DELUXE

### DELUXE MODEL 300 PSI

300 PSI high pressure air compressor Comes with nozzle adapters & sports needle. High power Deluxe model is able to inflate average sized, flat tyres in 5-7 minutes. Built-in handy pressure gauge (kpa & bar) Built-In safety / warning flashing light. or switch to work light for night use. 2.2M power cord with accessories plug. Storage compartment to keep leads, hose and adaptors tidy and out of the way. Excellent multi-purpose electronic compressor for the garage or boot. Size 100x260x160mm inclusive. TYRES, SPORTS & MATTRESS.

Code  
Y601

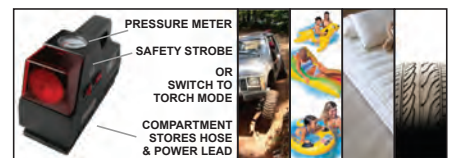

PRESSURE METER  
SAFETY STROBE  
OR  
SWITCH TO TORCH MODE  
COMPARTMENT STORES HOSE & POWER LEAD



# 18 CAR AUDIO ACCESSORIES

18 CAR AUDIO ACCESSORIES

## → Harness- Quick Disconnect

### QUICK DISCONNECT KIT

300 Assorted Pieces  
22-14 AWG (Red/Blue)

Code  
TMK300

Each plug is Available in Bulk packets of 100 See Section Seven  
PLUGS & SOCKETS



### AUTOMOTIVE QUICK DISCONNECT

Code  
QD2P



### AUTOMOTIVE QUICK DISCONNECT

Code  
QD4P

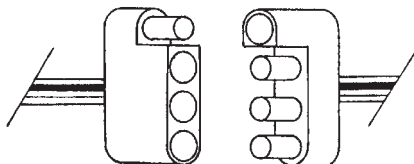

### AUTOMOTIVE QUICK DISCONNECT

Code  
QD6P

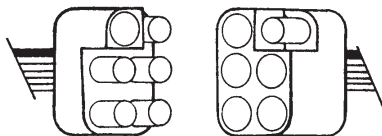

### 4 PIN CAR STEREO HARNESS

4 SET PINS:

Code  
WH10  
WH12  
WH14

UNIVERSAL  
Adjust pin location

Code  
UWH1

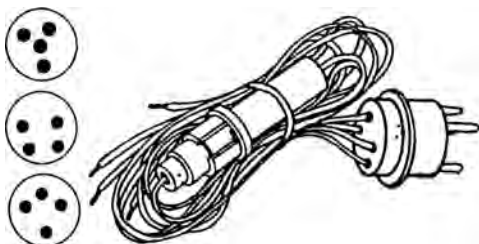

### DC POWER LEADS

Suit CB radio, etc.  
Plug to Bare wire.  
Fused. Red/Black.

Pins Code  
2 Pin DCL2  
3 Pin DCL3

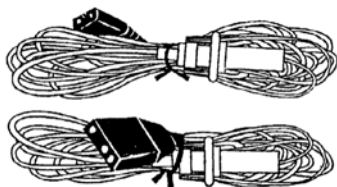

### UNIDEN RADIO DC LEAD

2 PIN POWER

Inline fuse 2A 2M  
x 18AWG lead

Description Code  
Square/Round DCL510  
Arch/Round DCL505



### "ISO" STEREO HARNESS FEMALE

Female "ISO" Connector to Bare Wire ends with EIA Colour. X2 (Power & Speaker)

Code  
APP7200

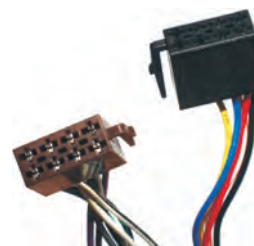

### "ISO" STEREO HARNESS MALE

Male "ISO" Connector to Bare Wire ends with EIA Colour. X2 (Power & Speaker)

Code  
APP7201



### 2 PIN CAR STEREO HARNESS

Code  
WH18

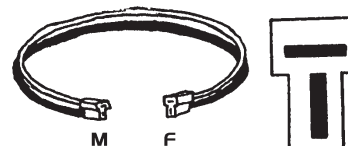

### 3 PIN CAR STEREO HARNESS

Code  
WH20

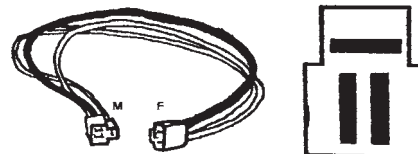

### 4 PIN CAR STEREO HARNESS

Code  
WH22

PLUG ONLY  
With Fuse Holder

Code  
WH16

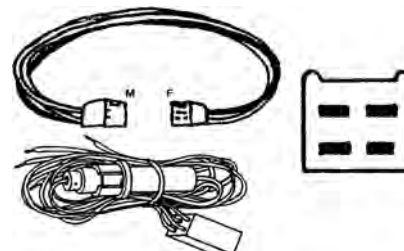

### 6 PIN CAR STEREO HARNESS

Code  
WH24

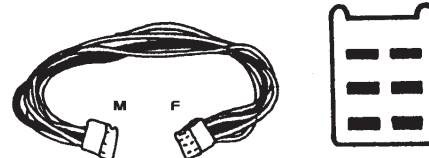

### 9 PIN CAR STEREO HARNESS

Code  
WH26

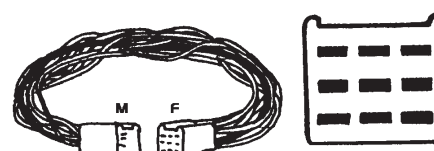



## → Harness - ISO Audio

### ISO CONNECTORS

#### International Organisation for Standardisation

Convert you car Dash and Aftermarket audio to ISO This will allow easier installation as connections now have compatibility.

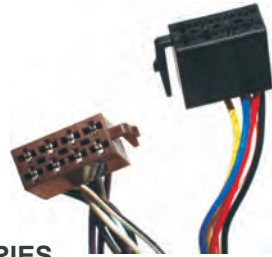

### ISO ADAPTORS - APP8 SERIES

#### AFTERMARKET AUDIO TO ISO

The APP8 series of harnesses are designed to plug directly into the back of a majority of aftermarket car audio like Alpine, Clarion, Sony, etc. giving you a male pair of ISO plugs on the other end to use.



### INSTRUCTIONS - APP8 SERIES

The male ISO connectors are then simply plugged into the corresponding car dash ISO adaptor APP SERIES plug as found on the following pages. Your After-Market car stereo is now compatible with your car!



### ALPINE TO ISO

#### SQUARE PINS 16

Adapts later model Alpine Car Audio to ISO compatibility. 16 Pin plug. Square holes.

Code  
APP8ALPH



### ALPINE TO ISO

#### ROUND PINS 16

Adapts later model Alpine Car Audio to ISO compatibility. 16 Pin plug. Round holes.

Code  
APP8ALPL



### CLARION TO ISO

#### LATEST 15 PIN

Adapts later model Clarion Car Audio to ISO compatibility. 15 Pin plug.

Code  
APP8CLA



### JVC TO ISO

#### 2X8 SINGLE PLUG

Adapts later model JVC Car Audio to ISO compatibility. 16 Pin plug.

Code  
APP8JVC



### KENWOOD TO ISO

#### 2000-2004 MODELS

Adapts early model Kenwood Audio to ISO compatibility. 14 Pin plug.

Code  
APP8KE



### KENWOOD TO ISO

#### 2005+ MODELS 16

Adapts later model Kenwood Audio to ISO compatibility. 16 Pin plug.

Code  
APP8KE1



### PANASONIC TO ISO

#### LATER MODELS

Adapts Panasonic Car Audio to ISO compatibility for easy install into your car.

Code  
APP8PAN



### PIONEER TO ISO

#### LATEST MODELS 14

Adapts latest model Pioneer Audio to ISO compatibility. 14 Pin plug.

Code  
APP8PIO



### SONY TO ISO

#### 16 PIN MODELS

Adapts latest model Sony car Audio to ISO compatibility. 16 Pin plug

Code  
APP8SP



### SOUND-4 TO ISO

#### SINGLE PLUG TYPE

Adapts latest model Sound-4 Car Audio to ISO compatibility.

Code  
APP8S41



### SOUND-4 TO ISO

#### DOUBLE PLUG TYPE

Adapts early model Sound-4 Car Stereo and other brands to ISO compatibility. 1x9 pin & 1x6 pin.

Code  
APP8S42





# 18 CAR AUDIO ACCESSORIES

## ISO ADAPTORS - APP SERIES

### CAR DASH PLUG TO ISO

The APP series of harnesses are designed to plug directly into the dash plug of your car to enable the use of aftermarket car audio with ISO conversion. All adaptors are ISO sockets. See APP8 Series for adaptors.



## INSTRUCTIONS - APP SERIES

### ISO TO AFTERMARKET CAR RADIO

If your aftermarket unit is NOT ISO then you will require an adaptor for it. See the APP8 Series on the previous pages for an APP8 to suit your brand of stereo.



## WIRING COLOUR GUIDE

RED	12V (+) ACCESSORIES
YELLOW	12V (+) CONSTANT
PINK	MUTE
BLACK	GROUND
BLUE	POWER ANTENNA
BLUE/WHITE	REMOTE
ORANGE	ILLUMINATION
ORANGE/WHITE	DIMMER
GREY	RIGHT FRONT (+)
GREY/BLACK	RIGHT FRONT (-)
WHITE	LEFT FRONT (+)
WHITE/BLACK	LEFT FRONT (-)
VIOLET	RIGHT REAR (+)
VIOLET/BLACK	RIGHT REAR (-)
GREEN	LEFT REAR (+)
GREEN/BLACK	LEFT REAR (-)

## ISO TO BMW

### Round Pin

Adapts dash plug to ISO so as to fit an after market stereo ISO compatibility. See APP8 Series

Code  
APP021



## ISO TO BMW

### Mini Cooper 2002-04 Square Pin

Adapts dash plug to ISO so as to fit an after market stereo ISO compatibility. See APP8 Series

Code  
APP022



## ISO TO CHRYSLER

### SUITS JEEP, etc.

Adapts dash plug to ISO so as to fit an after market stereo through ISO compatibility. See also APP8 Series.

Code  
APP020



## ISO TO DAEWOO

### SUITS MOST DAEWOO

Adapts dash plug to ISO so as to fit an after market stereo with ISO compatibility. See also APP8 Series.

Code  
APP030



## ISO TO DAIHATSU

### SUITS 1989+

Adapts dash plug to ISO so as to fit an after market stereo via ISO compatibility. See also APP8 Series.

Code  
APP040



## ISO TO FALCON AU

### SUITS 1998-2000

Adapts dash plug to ISO so as to fit an after market stereo ISO compatibility. See APP8 Series.

Code  
APP053



## ISO TO FALCON EA-ED

### SUITS 1988-1994

Adapts dash plug to ISO so as to fit an after market stereo ISO compatibility. See APP8 Series.

Code  
APP050





## ISO TO FALCON EF-EL

### SUITS 1995-1998

Adapts dash plug to ISO so as to fit an after market stereo w/ ISO compatibility. See the APP8 Series.

Code  
APP051



## ISO TO FORD

### Fiesta 2003/05

Adapts dash plug to ISO so as to fit an after market stereo ISO compatibility. See APP8 Series

Code  
APP054



## ISO TO FORD

### Focus , Fiesta , Mondeo , Transit

Adapts dash plug to ISO so as to fit an after market stereo ISO compatibility. See APP8 Series

Code  
APP055

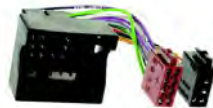

## ISO TO HOLDEN

### Astra , Vectra 1988 on , VY Commodore

Adapts dash plug to ISO so as to fit an after market stereo ISO compatibility. See APP8 Series

Code  
APP064



## ISO TO HOLDEN VN-VP

### COMMODORE 1988-1993

Adapts dash plug to ISO so as to fit an after market stereo ISO compatibility. See APP8 Series.

Code  
APP060



## ISO TO HOLDEN VR-VS

### COMMODORE 1993-1997

Adapts dash plug to ISO so as to fit an after market stereo ISO compatibility. See APP8 Series.

Code  
APP061



## ISO TO HOLDEN VT-VX

### COMMODORE 1997-2001

Adapts dash plug to ISO so as to fit an after market stereo ISO compatibility. See APP8 Series.

Code  
APP062



## ISO TO HONDA & SUZUKI

Suits Honda Accord, Civic, CR-V, Legend, HR-V, Prelude - 1999 on, Honda Jazz 2001 on, Suzuki Ignis, Jimny, Liana, 04/2002 on, Swift, Vitara, Wagon R+ 2006 on

Code  
APP071



## ISO TO HONDA 1986+

### MOST HONDAS

Adapts dash plug to ISO so as to fit an after market stereo ISO compatibility. See APP8 Series.

Code  
APP070



## ISO TO HYUNDAI

### EXCEL X1 86-89 SONATA 89-98

Adapts dash plug to ISO so as to fit an ISO after-market radio See APP8 Series.

Code  
APP080



## ISO TO HYUNDAI

### EXCEL X2/X3 90-00 ACCENT 00-05 LANTRA 91-00

Adapts dash plug to ISO 3rd-party radio See APP8 Series.

Code  
APP081



## ISO TO HYUNDAI

### ELANTRA 00-05 SANTA FE 00-05 SONATA 99-05

Adapts dash plug to ISO after market unit See APP8 Series.

Code  
APP085



## ISO TO HYUNDAI

### 2005 on, Kia 2004 on

Adapts dash plug to ISO so as to fit an after market stereo ISO compatibility. See APP8 Series

Code  
APP086



## ISO TO KIA

### Pregio 1995-02

Adapts dash plug to ISO so as to fit an after market stereo ISO compatibility. See APP8 Series

Code  
APP074





# 18 CAR AUDIO ACCESSORIES

18 CAR AUDIO ACCESSORIES

## ISO TO MAZDA

Mazda 3 2003 on, Tribute 2000 on

Adapts dash plug to ISO so as to fit an after market stereo ISO compatibility. See APP8 Series

Code  
APP072

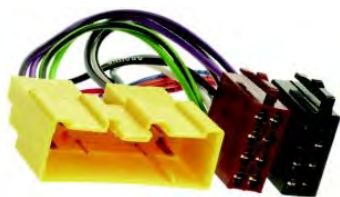

## ISO TO SAAB

Saab 9.3 1993 - 2006 / Alfa 1993 on

Adapts dash plug to ISO so as to fit an after market stereo ISO compatibility. See APP8 Series

Code  
APP075



## ISO TO MITSUBISHI

EARLY 2 PLUG TYPE

Adapts dash plug to ISO so as to fit an after market stereo ISO compatibility. See APP8 Series.

Code  
APP0110



## ISO TO SUBARU

MOST MODELS

Adapts dash plug to ISO so as to fit an after market stereo ISO compatibility. See APP8 Series

Code  
APP090



## ISO TO MITSUBISHI

LATE 1 PLUG TYPE

Adapts dash plug to ISO so as to fit an after market stereo ISO compatibility. See APP8 Series.

Code  
APP0111



## ISO TO SUBARU

Subaru 2007 on

Adapts dash plug to ISO so as to fit an after market stereo ISO compatibility. See APP8 Series

Code  
APP091



## ISO TO NISSAN

Nissan 2000 on

Adapts dash plug to ISO so as to fit an after market stereo ISO compatibility. See APP8 Series

Code  
APP073



## ISO TO SUZUKI

LATE MODELS

Adapts dash plug to ISO so as to fit an after market stereo ISO compatibility. See APP8 Series.

Code  
APP0130



## ISO TO NISSAN

1995+

Adapts dash plug to ISO so as to fit an after market stereo ISO compatibility. See APP8 Series.

Code  
APP0120



## ISO TO TOYOTA

EARLY MODEL 2 PLUG

"Smaller" 2-Plug type Adapts dash plug to ISO so as to fit an after market stereo ISO compatibility.

Code  
APP0140



## ISO TO NISSAN

1987-1994

Adapts dash plug to ISO so as to fit an after market stereo ISO compatibility. See APP8 Series.

Code  
APP0121



## ISO TO TOYOTA

LATE MODEL 2 PLUG

"Larger" 2-Plug type Adapts dash plug to ISO so as to fit an after market stereo ISO compatibility.

Code  
APP0141





## → Harness - OEM Audio Bare Wire

### WIRE HARNESS - AP SERIES

#### CAR DASH PLUG TO WIRE

The AP series of harnesses are designed to plug directly into the dash plug of your car to enable the use of aftermarket car audio without cutting the original cars wiring looms. Maintain factory condition.



### CHRYSLER JEEP

#### 16 PIN

Wired this directly to your aftermarket car audio unit and then plugs directly into your vehicles harness.

Code  
AP1020



### DAIHATSU 1989+

#### 1X9 + 1X5 PLUG

Wire this directly to your aftermarket car audio unit and then plugs directly into your vehicles harness.

Code  
AP1398D



### FORD FALCON AU

#### 14 PIN 1997-2002

Wire this directly to your aftermarket car audio unit and then plugs directly into your vehicles harness.

Code  
AP1053



### FORD FALCON EA-ED

#### 12 PIN 1988-1994

Wire this directly to your aftermarket car audio unit and then plugs directly into your vehicles harness.

Code  
AP1692F



### FORD FALCON EF-EL

#### 1X4+1X8 1995-1998

Wire this directly to your aftermarket car audio unit and then plugs directly into your vehicles harness.

Code  
AP7901F



### HOLDEN VN-VP

#### 13 PIN 1988-1993

Wire this directly to your aftermarket car audio unit and then plugs directly into your vehicles harness.

Code  
AP1782H



### HOLDEN VR-VS

#### 13 PIN 1993-1998

Wire this directly to your aftermarket car audio unit and then plugs directly into your vehicles harness.

Code  
AP1783H



### HOLDEN VT-VX

#### 13 PIN 1997-2001

Wire this directly to your aftermarket car audio unit and then plugs directly into your vehicles harness.

Code  
AP1784H



### HONDA

#### 12 PIN 1986+

Wire this directly to your aftermarket car audio unit and then plugs directly into your vehicles harness.

Code  
AP1720



### HYUNDAI EARLY

#### 11 PIN 1986-1991

Wire this directly to your aftermarket car audio unit and then plugs directly into your vehicles harness.

Code  
AP1736



### HYUNDAI MID

#### 14 PIN 1991-2000

Wire this directly to your aftermarket car audio unit and then plugs directly into your vehicles harness.

Code  
AP7300



### HYUNDAI LATE

#### 14 PIN 2000+

Wire this directly to your aftermarket car audio unit and then plugs directly into your vehicles harness.

Code  
AP7350





# 18 CAR AUDIO ACCESSORIES

18 CAR AUDIO ACCESSORIES

## MAZDA 90'S

### 1X4+1X8 1990-1997

Wire this directly to your aftermarket car audio unit and then plugs directly into your vehicles harness.

Code  
AP7901F



## TOYOTA EARLY

### LARGER 2 PLUG

Wire this directly to your aftermarket car audio unit and then plugs directly into your vehicles harness.

Code  
AP1398T



## MITSUBISHI EARLY

### 1X4+1X8 2 PLUG

Wire this directly to your aftermarket car audio unit and then plugs directly into your vehicles harness.

Code  
AP7010



## TOYOTA LATE

### 1X5+1X10 2 PLUG

Wire this directly to your aftermarket car audio unit and then plugs directly into your vehicles harness.

Code  
AP1761



## MITSUBISHI LATE

### 11 PIN SINGLE PLUG

Wire this directly to your aftermarket car audio unit and then plugs directly into your vehicles harness.

Code  
AP7011



## CAR DASH PLUG - 71 SERIES

### ORIGINAL DASH PLUGS

If the original dash plug was cut & removed and you now want to replace it, use this. The 71 Series is for restoring to original. Put the factory back in.

# OEM FACTORY STEREO

## NISSAN EARLY

### 1X5+1X8 1987-1994

Wire this directly to your aftermarket car audio unit and then plugs directly into your vehicles harness.

Code  
AP7551



## DAIHATSU 1989+

### DASH PLUGS 9+5

Replaces the original factory dash plug loom if missing or removed from an after-market car radio installation

Code  
711398D



## NISSAN LATE

### 1X6+1X9 1995+

Wire this directly to your aftermarket car audio unit and then plugs directly into your vehicles harness.

Code  
AP7550



## FORD LASER KN & FESTIVA

### DASH PLUG 4+8

Great for reinstalling the original factory head unit or restoring your system back to the way it was.

Code  
711052



## SUZUKI

### 11 PIN

Wire this directly to your aftermarket car audio unit and then plugs directly into your vehicles harness.

Code  
AP1130



## FORD FALCON AU

### DASH PLUGS 18 PIN

Replaces the original factory dash plug loom if missing or removed from an after-market car radio installation

Code  
711053



## SUBARU

### 13 PIN

Wire this directly to your aftermarket car audio unit and then plugs directly into your vehicles harness.

Code  
AP2001







## CAR DASH PLUG - CONTINUED

### ORIGINAL DASH PLUGS

If the original dash plug was cut & removed and you now want to replace it, use this. The 71 Series is for restoring to original Put the factory back in.



## FORD FALCON EA-ED

### DASH PLUG 12 PIN

Great for reinstalling the original factory head unit or restoring your system back to the way it was.

Code  
711692F



## FORD FALCON EF-EL

### DASH PLUGS 4+8

Replaces the original factory dash plug loom if missing or removed from an after-market car radio installation

Code  
717901F



## HOLDEN COMMODORE VN-VP

### DASH PLUG 13 PIN

Great for reinstalling the original factory head unit or restoring your system back to the way it was.

Code  
711782H



## HOLDEN COMMODORE VR-VS

### DASH PLUG 13 PIN

Replaces the original factory dash plug loom if missing or removed from an after-market car radio installation

Code  
711783H



## HYUNDAI 1991-2000

### DASH PLUG 14 PIN

Replaces the original factory dash plug loom if missing or removed from an after-market car radio installation

Code  
717300



## HYUNDAI 1986-91

### DASH PLUG 11 PIN

Great for reinstalling the original factory head unit or restoring your system back to the way it was.

Code  
711736



## MITSUBISHI SINGLE

### DASH PLUG 12 PIN

Replaces the original factory dash plug loom if missing or removed from an after-market car radio installation

Code  
717011



## MITSUBISHI DUAL

### DASH PLUGS 7+5

Great for reinstalling the original factory head unit or restoring your system back to the way it was.

Code  
717010



## NISSAN 1995+

### DASH PLUGS 6+10

Replaces the original factory dash plug loom if missing or removed from an after-market car radio installation

Code  
717550



## TOYOTA EARLY

### DASH PLUGS 9+5

Great for reinstalling the original factory head unit or restoring your system back to the way it was.

Code  
711398D



## TOYOTA 1987-96

### DASH PLUGS 10+5

Great for reinstalling the original factory head unit or restoring your system back to the way it was.

Code  
711761





# 18 CAR AUDIO ACCESSORIES

## → Antennas

### ↓ Universal

#### UNIVERSAL

##### HIGH ANGLE

Hilux, Rodeo Land Cruiser and much more!

**FULLY AUTO** Stainless steel mast. Non-replaceable High angle.

Up 72cm  
Lead 140cm

Code  
AP22



#### UNIVERSAL

##### SEMI AUTO

Manual toggle switch control. Universal mount  
Non-replaceable Stainless steel Mast. Top Cowl.

Up 72cm  
Lead 140cm

Code  
AP24



#### UNIVERSAL

##### FULLY-AUTO

Mast AP12\*  
Up 97cm  
Lead 140cm

##### Chrome Mast\*

Code  
AP10A

##### Black Mast

Code  
AP10



#### DELUXE KIT #1

11 X Head Kits! Angled 0 to 68° Suits many vehicles Alpha  
Audi Astra to Vectra Honda Hyundai 300mm under guard

Mast AP12  
Sect. 5  
Up 99cm  
Lead 140cm

Code  
AP178



#### DELUXE KIT #2

4X Head Kits! Fully automatic antenna. Multi-angles 0-45° & Curved mounts Rodeo,  
Beetle, Hilux Land Cruiser, etc. Detachable Cable

Mast AP12  
Sect. 5  
Up 99cm  
Lead 140cm

Code  
AP176



#### REPLACEMENT MAST Stainless Steel

Replacement mast that suits many  
AERPRO fully auto antennas  
including but not limited to:

Suit AP2,  
AP4,  
AP6,  
AP10,  
AP10A

Code  
AP12

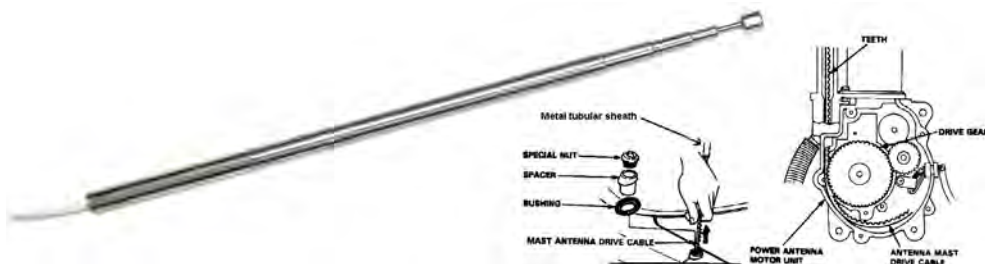



## HIGH QUALITY AUTO ACCESSORIES

ALL AERPRO CAR  
ANTENNAS ARE SUPPLIED  
PACKAGED UNLESS  
INDICATED BULK

### LOCK DOWN

Sect. 4  
Up 75cm  
Lead 130cm  
**Chrome Plated**  
Bulk. No packaging.

Code  
AP64

**Black Anodised**

Code  
AP66B

**Stainless Steel**

Code  
AP62



### UNIVERSAL

Top Cowl  
Up 96cm  
Lead 122cm

Code  
AP30



### SPRING-BALL

**HEAVY DUTY**  
Sect. 4  
Up 190cm  
Lead 152cm

Code  
AP44



### GLASS MOUNT

**AM/FM WITH  
BOOSTER**  
Up 51cm  
Lead 456cm

Code  
AP104



### SPRING BASE

Fully Retractable  
Sect. 4  
Up 122cm  
Lead 122cm

Code  
AP76



### SPRING-BALL

**BOOSTER  
COIL IN  
MAST**  
Sect. 3  
Up 134cm  
Lead 127cm

Code  
AP46



### GUTTER MOUNT

**SPRING BASE**  
Stainless Steel  
Sect 3  
Up 78cm  
Lead 198cm

Code  
AP92



### UNIVERSAL

Lock-Down Chrome  
Plated Two Heads  
for both standard  
or smaller type  
European cars, etc.  
Up 95cm  
Sect. 5  
Lead 1.5M

Code  
AP63



### SPRING-BALL

Sect. 3  
Up 120cm  
Lead 137cm

**STEEL**  
Code  
AP40

**BLACK**  
Code  
AP42B



### SPRING-BALL

**FIBRE GLASS**  
Sect. 1  
Up 152cm  
Lead 137cm

Code  
AP48B



### CENTRE ROOF

**SPRING BASE**  
Up 80cm  
Sect. 4  
Lead 200cm

Code  
AP100





# 18 CAR AUDIO ACCESSORIES

18 CAR AUDIO ACCESSORIES

## SIDE MOUNT

Suit Trucks, Vans,  
Up 185cm  
Sect. 3  
Lead 245cm  
Code  
AP90



## RUBBER DUCK

Suit Universal  
Up 37cm  
Lead 125cm  
Code  
AP102



## HOLDEN ASTRA

HATCH 96-98  
Cable Detach  
Head 62°  
Lead 60cm  
Code  
AP162



## BARINA

MAZDA-3  
SUZUKI MG +

ROOF MOUNT  
MAST ONLY  
Stainless steel  
Black anodised  
Base 5mm  
Up 41cm  
Code  
AP153



## PILLAR MOUNT

Suit Universal  
Up 120cm  
Sect. 3  
Lead 122cm  
Code  
AP120



## HIGH ANGLE

Universal  
Sweep-back  
Suit VW,  
Hilux 83-88, etc.  
Sect. 4  
Up 100cm  
Lead 120cm  
Code  
AP60



## HOLDEN ASTRA

SEDAN 96-98  
Cable Detach  
Head 26°  
Lead 60cm  
Code  
AP165



## HOLDEN NOVA

LE-LF 89→94  
Pillar Mount  
Sect 2 Up 90cm  
Lead 131cm  
Code  
AP192



## PILLAR MOUNT

Suit Universal  
Up 120cm  
Sect. 3  
Lead 120cm  
Code  
AP122



## JACKAROO

UBS 81→87  
Guard Mount  
Sect 4  
Up 86cm  
Lead 160cm  
Code  
AP78



## JACKAROO

1992→2001  
Guard Mount  
Mast AP12  
Sect 5  
Up 97cm  
Lead 140cm  
Code  
AP180



## VECTRA

PILLAR MOUNT  
MAST ONLY  
Suit JR-JS, 97+  
Code  
AP153A





## COMMODORE VN

Suit VN→VS  
Sect. 5  
Up 100cm  
Lead 122cm

Code  
AP70



## COMMODORE VT

Suit VT→VY  
Sect. 5  
Up 98cm  
Lead 43cm

Code  
AP71



## COMMODORE VY-II

VY-II→VZ  
Mast AP265  
Up 126cm  
Lead 127cm

Code  
AP9



## FALCON EA

EA/EB/ED  
Up 123cm  
Lead 122cm

Code  
AP68



## COMMODORE VB

Suit VB→VL  
Sect. 5  
Up 110cm  
Lead 122cm

Code  
AP72



## COMMODORE VN

VN→VS  
Fully Auto  
Sect. 5  
Up 99cm  
Lead 50cm

Code  
AP6



## COMMODORE VT

VT Series I  
Mast AP12  
Sect. 5  
Up 99cm  
Lead 50cm

Code  
AP7



## COMMODORE VY-II

VY-II→VZ  
Mast only  
Up 126cm  
Lead 127cm

Code  
AP265



## FALCON EA

REPLACE replacing factory fitted auto antenna

EA→ED  
Semi-Auto  
Sect. 5  
Up 99cm  
Lead 140cm

Code  
AP2



## COMMODORE VB

VB→VL +  
4 Heads suit most cars.  
Up 97cm  
Lead 140cm Detachable

Code  
AP10



## COMMODORE VN

VN VP VR VS VT  
Original Auto Mast  
MAST ONLY  
OEM Replace  
Sect. 5  
Up 106cm  
Suit VN→VT

Code  
AP250



## COMMODORE VT-II

VT-II → VY-I  
VT Series-II  
Mast AP250  
Up 99cm  
Lead 50cm

Code  
APVY1F



## FALCON AU

AU  
Up 100cm  
Lead 50cm

Code  
AP67



## FALCON EA

UPGRADE For replacing factory fitted lockdown antenna. Fully-Auto

EA→ED  
Sect. 5  
Up 99cm  
Lead 48cm

Code  
AP4





# 18 CAR AUDIO ACCESSORIES

18 CAR AUDIO ACCESSORIES



## FALCON EF

**UPGRADE**  
replacing factory  
fitted lockdown  
antenna NEW  
install

EF→EL  
6/96+ Fully-Auto  
Sect. 5  
Up 99cm  
Lead 48cm

Code  
AP5



## FORD LASER

**Pillar Mount**  
SEE ALSO MAZDA  
Up 89cm  
Lead 208cm

Code  
AP158



## FORD COURIER

1999+  
Pillar Mount  
Sect. 1  
Up 80cm  
Lead 243cm

Code  
AP191



## HONDA ACCORD

**R/H Side Pillar**  
Accord 81 up  
Up 95cm  
Sect. 2  
Lead 178cm

Code  
AP128



## FALCON EF

EF EL 95+  
Up 100cm  
Lead 50cm

Code  
AP69



## FORD FESTIVA

1994-2002  
Pillar mount 1  
section  
Up 84cm  
Lead 250cm

Code  
AP185



## FORD LASER

KF-KH  
Pillar Mount  
Sect. 1  
Up 92cm  
Lead 215cm

Code  
AP175



## FORD TRANSIT

ROOF 96+  
Up 55cm  
Lead 200cm

Code  
AP186



## HONDA ACCORD PRELUDE

Original Auto Mast  
Suit 95/96

Code  
AP251



## FALCON EF

**REPLACE**  
replacing  
factory fitted  
autoantenna  
OEM replace

EF→EL  
Semi-Auto  
Sect. 5  
Up 99cm  
Lead 140cm

Code  
AP3



## FORD FOCUS KA

KA 99-02  
FOCUS 02+  
Screw base  
Length 55cm  
Base 5mm

Code  
AP195



## FORD TELSTAR

AT-AV  
87 → 92.  
Pillar Mount  
Sect. 1  
Up 86cm  
Lead 130cm

Code  
AP174



## HONDA CIVIC

Prelude 80-82  
Accord upto 81  
Up 95cm  
Sect. 2  
Lead 195cm

Code  
AP124



## HONDA ACCORD

94+  
Fully-Auto  
Sect. 5  
Up 99cm  
Lead 200cm

Code  
AP8





## HYUNDAI ACCENT

2000+  
Guard mount  
Sect. 4  
Up 88cm  
Lead 18cm

Code  
AP181



## HYUNDAI LANTRA

1991-2000  
Guard mount  
Sect. 5  
Up 85cm

Code  
AP184



## HYUNDAI EXCEL

Suit 90-94  
Sect. 5  
Up 100cm  
Lead 170cm

Code  
AP83



## TOYOTA CAMRY

Suit 95/96

Code  
AP82



## HONDA CIVIC

Pillar Mount  
Up 94cm  
Lead 188cm

Code  
AP132



## HYUNDAI ACCENT

OEM MAST

MAST 2000+  
Replaces original  
Mast for OEM Auto  
Sect. 4  
Up 88cm

Code  
AP264



## ELANTRA

MAST 2001+  
Replacement  
mast Suit  
OEM auto  
Sect. 5  
Up 85cm

Code  
APXD3M



## HYUNDAI EXCEL

Suit 94+  
Sect. 5  
Up 84cm  
Lead 24cm

Code  
AP84



## TOYOTA CAMRY

Suit 97/02

Code  
AP196



## HONDA CR-V

99+  
Rubber whip  
Active amp.  
Up 18cm  
Lead 19cm

Code  
AP198



## HYUNDAI ACCENT

2000+  
Fully auto Mast AP12  
Sect. 4  
Up 88cm  
Lead 18cm

Code  
AP190



## ELANTRA

2001+  
Fully auto  
Sect. 5  
Up 83cm

Code  
APXD1F



## TOYOTA COROLLA

Pillar Mount  
Up 93cm  
Sect. 2  
Lead 107cm

Code  
AP138



## TOYOTA CAMRY

Suit 97/02

Code  
AP197





# 18 CAR AUDIO ACCESSORIES

18 CAR AUDIO ACCESSORIES

## HILUX / RODEO



1988→1997  
Up 90cm  
Sect. 4  
Lead 124cm  
**Code**  
AP77

## LAND CRUISER

GXL



1990→1998  
Guard Mount  
Lead 126c  
**Code**  
AP73

## COROLLA ECHO

AVENSIS  
PRIUS



2001+  
Roof Mount  
Whip 77cm  
**Code**  
AP187

## DATSUN 200B



Pillar Mount  
Up 128cm  
Sect. 3  
Lead 142cm  
**Code**  
AP142

## PULSAR



1996  
Up 105cm  
Sect. 2  
Lead 245cm  
**Code**  
AP148

## HILUX



1997+  
Guard Mount  
Up 84cm  
Sect. 4  
**Code**  
AP188

## LAND CRUISER

100



1998+  
Mast Only Suit  
OEM Auto antenna  
**Code**  
AP266

## COROLLA ECHO



Corolla 02→05  
Echo 03+  
Roof Mount  
Whip 41cm  
**Code**  
AP153

## PULSAR

Ford Corsair  
Econovan



1987 → 1992  
Up 89cm  
Sect. 1  
Lead 175cm  
**Code**  
AP146

## PULSAR



N16 2000+  
Pillar mount  
Up 97cm  
Sect. 2  
Lead 245cm  
**Code**  
AP149

## LAND CRUISER

GXL



1990→1998  
Mast Only Suit  
OEM Auto  
antenna  
**Code**  
AP255

## COROLLA

STARLET



82→88  
Pillar Mount  
Whip 90cm  
Lead 131cm  
**Code**  
AP192

## JEEP

CHEROKEE 85+



Up 79cm  
Lead 203cm  
**Code**  
AP168

## PULSAR



1992 → 1995  
Up 94cm  
Sect. 2  
Lead 215cm  
**Code**  
AP147

## NAVARA

PATHFINDER  
Push-Down  
Guard mount  
1986-1989



LEFT MOUNT  
Sect. 4  
Up 100cm  
Lead 170cm  
Left  
**Code**  
AP79

RIGHT MOUNT  
Sect. 4  
Up 100cm  
Lead 170cm  
Right  
**Code**  
AP80





## NAVARA

### PATHFINDER



Navara 93→97  
Path' 92-95  
RH Mount  
Sect. 4  
Up 94cm  
Lead 70cm

**Code**  
AP81

## NISSAN X-TRAIL



2001+  
Roof rubber  
Whip 18cm  
Lead 276cm

**Code**  
AP199

## SUBARU

### LIBERTY WAGON OEM replace



90→94  
MAST ONLY  
Replacement for  
original  
Sect. 5  
Up 99cm

**Code**  
AP257

## SUZUKI JIMNY



00→05  
Up 90cm  
Sect. 2  
Lead 131cm

**Code**  
AP192

## MAGNA



Original Auto Mast  
Sect. 5  
Up 93cm  
Suit 95 → 97

**Code**  
AP253

## NAVARA



Suit 2000+  
Guard Mount  
Sect. 4  
Up 5cm  
Lead 8cm

**Code**  
AP183

## SUBARU



Sect. 5  
Up 97cm  
Lead 173cm

**Code**  
AP74

## SUZUKI & BARINA



Suit '92 up  
Up 92cm  
Lead 201cm

**Code**  
AP152

## MAGNA



85/91  
Up 92cm  
Lead 264cm

**Code**  
AP154

## MAGNA



96+  
Sect. 4  
Up 84cm  
Lead 270cm

**Code**  
AP88

## NISSAN PATROL



Original  
Auto Mast  
Sect. 5  
Up 100cm  
Suit 89→93

**Code**  
AP252

## SUBARU

### LIBERTY SEDAN OEM replace



90→94  
MAST ONLY  
Replacement  
for original  
Sect. 7  
Up 103cm

**Code**  
AP256

## SUZUKI CARRY



Carry 99→00  
Ignis 00→05  
Up 94cm  
Sect. 2  
Lead 195cm

**Code**  
AP193

## MAGNA



91 → 94  
Up 90cm  
Lead 269cm

**Code**  
AP156

## MAGNA



96+  
Fully-Auto  
Sect. 5  
Up 89cm  
Lead 200cm

**Code**  
AP179



# 18 CAR AUDIO ACCESSORIES

18 CAR AUDIO ACCESSORIES

## PAJERO



Suit 80→93  
Guard Mount  
Sect 4  
Up 86cm  
Lead 160cm

Code  
AP78

## PAJERO



1983→1987  
Guard Mount  
Mast AP12  
Sect 5  
Up 97cm  
Lead 140cm

Code  
AP180

## MAZDA 323 85+



Pillar Mount  
Up 89cm  
Lead 208cm

Code  
AP158

## VW GOLF



1992→1996  
Guard mount 68°  
Cable detach  
Lead 60cm

Code  
AP161

## PAJERO



Suit 00→02  
Pillar Mount  
Sect 5  
Up 94cm  
Lead 141cm

Code  
AP182

## VERADA



Suit 00→02  
Replace OEM  
Mast auto  
Sect 5  
Up 94cm

Code  
AP263

## MAZDA 626



Mast Only  
Suit 95+  
Up 97cm

Code  
AP254

## VW PASSAT



1995→1997  
Mast Only  
Base 5mm  
Length 41cm

Code  
AP153

## PAJERO MAST



2000→2004  
Replaces OEM  
Mast Auto  
Sect 7  
Up 9cm

Code  
AP262

## MAZDA 121



Suit 95+  
Pillar Mount  
Sect 1  
Up 89cm  
Lead 208cm

Code  
AP159

## MERCEDES BENZ



Universal  
Fully-Auto 180,  
190, 200, 300  
W124, W201  
Sect. 5  
Up 99cm  
Lead 140cm  
Mast AP12

Code  
AP178

## TAIL STRAPS

Soft bendable  
anchor straps.

340 x 19mm

Code  
TS34019

340 x 25mm

Code  
TS34025



## AUTOMOTIVE COMMUNICATION ANTENNAS

### SEE SECTION 19





↓ Accessories

## ANTENNA EXTENSION LEADS

### MALE → FEMALE

Length	Code
0.6M	CAL60
1.2M	CAL120
3.6M	CAL360
5.0M	CAL500



## FM ANTENNA BOOSTER

Adapts inline to any AM/FM car antenna & boosts the FM signal by 10dB. Quality steel box.

Code  
AP342



## ANTENNA PLUG

### STANDARD TYPE

Code  
CAP10



## ANTENNA PLUG

### SCREW TYPE

Code  
CAP20



## ANTENNA SOCKET

### STANDARD TYPE

Code  
CAS10



## INLINE SOCKET

Code  
CAS50



## RIGHT ANGLE ADAPTOR

### 90° PLUG

Tight installation? This adaptor allows for space limited behind the radio Plug to Socket

Code  
AP332



## EUROPEAN ADAPTOR

Car radio adaptors Change a standard radio to suit a European antenna.

Code  
AD655



## EUROPEAN ADAPTOR

Change a Standard radio to suit European antenna.

Code  
CAL655



## EUROPEAN ADAPTOR

### BUILT-IN FM BOOSTER

Adapts Euro → Aust. Change a Standard radio to suit European antenna when installing a new radio into a European car. Ideal for demister antenna. 5-10dB FM Boosted.

Code  
AP3421



## EUROPEAN ADAPTOR

Change European radio to standard Australian socket. eg. Install a Becker-Mexico into a Ford-Falcon. Gold plated plug socket

Code  
AD653



## EUROPEAN ADAPTOR

Change European radio to standard Australian socket.

Code  
CAL653



## ANTENNA SPLITTER

### MALE TO 2X FEMALE

Installs an aftermarket radio into a car with dual diversity (two) antennae and combines them into one input.

Code  
AP339



↓ Accessories

## 20MHZ FM EXPANDER for JAPAN RADIO

### SHIFTS FM BAND DOWN BY 20MHZ

Converts Australian FM frequency so it can be received by a Japan/Hong Kong Car Radio. Simply plug in-line with the existing car antenna. 12V

Code  
AP745





# 18 CAR AUDIO ACCESSORIES

18 CAR AUDIO ACCESSORIES

## ↓ Accessories

### GM MINI PLUG

Adaptor Cable 10cm Plug GM Mini Socket Standard Type

Code  
AP347



### NISSAN DIVERSITY ADAPTOR

NEW RADIO / CAR ANTENNA  
Connect an aftermarket radio into the existing diversity antenna system (2x antennae)

Code  
AP348A



### NISSAN DIVERSITY ADAPTOR

CAR RADIO / NEW ANTENNA  
Connect an aftermarket antenna into the existing dual-diversity car radio system (2x antennae)

Code  
AP348B



### VOLVO ANTENNA ADAPTOR

VOLVO 1999+  
Converts original radio To after-market antenna

Code  
APA32



### VW & BMW ANTENNA ADAPTOR

VW & BMW 2002+

Description Code  
Converts original radio To after-market antenna APA33

Description Code  
Converts car antenna To after-market radio APA34

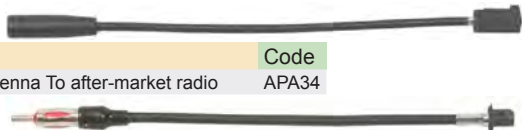

### CHRYSLER JEEP ADAPTOR

CHRYSLER JEEP 2002+

Description Code  
Converts car antenna To after-market radio APA36

Description Code  
Converts original radio To after-market antenna APA37

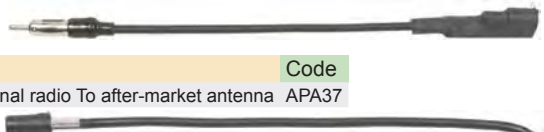

### BMW VOLVO MERCEDES

ANTENNA ADAPTOR  
Converts OEM Radio to Aftermarket antenna

Code  
APA38



### "Z" BRACKET BENELEC

Boot/bonnet lip mount, etc. Benelec quality

Type Code  
Zinc Plated ZB35  
Stainless Steel ZB36

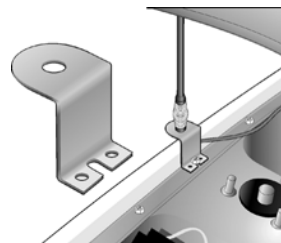

### MOUNTING STRAP

135mm STAND-OFF "L"  
Steel enamel painted black Wall, caravan, cab mount, etc.

Code  
WB40

### STAINLESS STRAIGHT

Code  
MMM1



### MIRROR MOUNT BENELEC

BENELEC BRACKET  
Suits 1 1/4" Pole mount (Pole not included)

Type Code  
Zinc MM4  
Stainless Steel MM5



### BULL-BAR MOUNT BENELEC

2" HORIZONTAL  
Grip teeth U bolts.

Code  
BB35

### STAINLESS STEEL

Code  
BB36



### BULL-BAR STRAP BENELEC

SIDE/TOP MOUNT  
Suits 2" Horizontal Bar  
Stainless steel quality. Strap design for safe front bull-bar mount As legally required.

Code  
BB32



### GUTTER MOUNT BENELEC

Screw clips into the gutter roof of trucks vans and older cars. Chrome plated body with Stainless steel hardware Benelec quality.

Code  
CBA36



### MORE COMMUNICATION ACCESSORIES

We stock a large comprehensive range of Accessories for CB, UHF, SSB, etc.

Please Enquire !





## → AERPRO CROSS-REFERENCE

MAKE	MODEL	MANUAL ANTENNA	AUTO ANTENNA	OEM MAST	FACIA	HARNESS	ISO ADAPTOR	
Alfa Romeo	33, 75, 164. 1984-1993	AP63	AP178				APP075	
	147. 2000-2009				FP9147		APP075	
	147. 2006-2009				FP9148		APP075	
	156. 2001-				FP9156			
	159. 2005-				FP9157		APP075	
	159. 2005-				FP9159		APP075	
	ALPHETTA. 1974-1988	AP63	AP178					
	ALPHASUD. 1976-1989	AP63	AP178					
	GTV. --2003				FP9038			
	GTV. 2003--				FP9039			
	SPIDER. --2003				FP9038			
	SPIDER. 2004-2004				FP9159			
	SPRINT. 1976-1989	AP63	AP178					
	MILANO. 1976-1989	AP63	AP178					
	Audi	100. 1984-1988	AP63	AP178		FP999001		
		200. 1984-1990	AP63	AP178		FP999001		
		80. 1988-1992	AP63	AP178		FP999001		
90. 1989-1992		AP63	AP178		FP999001			
A3. 2003--					FP9094			
A3 (with Symphony OEM-Radio) . 2003--					FP9090			
A3. 2007--					FP9090			
A4. 1996-1999					FP999100			
A4. 2002-2002					FP9102			
A4. 2008-2010								
A4 AVANT. 1998-1999					FP999100			
A6 (C4 Chassis). 1995-1997		AP63	AP178		FP999100			
A6. 2002-2004					FP9103			
A8 (D2 Chassis). 1995-2003		AP63	AP178					
AUSTIN	METRO (Rover Metro). 1986-1990	AP62A	AP10A					
	MONTEGO. 1985-1988	AP62A	AP10A					
	MINI COOPER. 1977-1993	AP62A	AP10A					
BENTLEY	ALL MODELS. 1977-		AP178					
BMW	1 SERIES. 2004-				FP9134			
	3 SERIES. 2008-2008							
	3 SERIES (E30 Chassis). 1984-1991	AP63	AP178					
	3 SERIES (E36 CONVERTIBLE). 1991-1998		AP178					
	318. 1999-				FP999300			
	323. 1997-2000				FP999300			
	325. 2001-				FP999300			
	328. 1997-2000				FP999300			
	330. 2001-				FP999300			
	5 SERIES. 1980-1989	AP63	AP178					
	6 SERIES. 1980-1989	AP63	AP178					
	7 SERIES. 1987-1994		AP178					
	X3. 2004-				FP9034			
	X5. -							
Z3 (E36-7 Chassis). 1997-2002		AP178						
Z4. 2003-				FP9143				
CHEVROLET	BLAZER TRUCK. 1981-2005	AP62A	AP10A					
	CAMARO. 1993-1996				FP994000			
	CAMARO. 1997-2000				FP993300			
	CORVETTE. 1997-2002				FP993300			
	FIREBIRD. 1993-2002				FP994000			
	METRO (sedan). 1998-2001	AP152						
	SUBURBAN. 1995-1999				FP993002			
CHRYSLER	300M 2 DOOR,CONCORDE,SEBRING. 1999-2001	AP62A	AP178					
	NEON. 1974-2001				FP996700			
	VOYAGER. 1974-2001				FP996700			
CITROEN	C1. -				FP9115			
	C4. -				FP9044			
	C5. 2001-2005				FP9051			
	C5. 2005-				FP9155			
DAEWOO	ESPERO. 1990-1996	AP62A	AP178				APP030	
	LANOS 2 & 4 DOOR. 1998-2002	AP60	AP178		FP998800		APP030	
	LEGANZA 2 & 4 DOOR. 1997-2000	AP62A	AP178		FP998800		APP030	
	NUBIRA J150 CDX SEDAN. 1997-2003		AP178		FP998800		APP030	
DAIHATSU	FEROZA / ROCKY. 1989-1998	AP142				AP1398T	APP040	



# 18 CAR AUDIO ACCESSORIES

18 CAR AUDIO ACCESSORIES

## → AERPRO CROSS-REFERENCE

MAKE	MODEL	MANUAL ANTENNA	AUTO ANTENNA	OEM MAST	FACIA	HARNESS	ISO ADAPTOR
DODGE	AVENGER. 2007-2008				FP996511		
	DAKOTA. 2008-				FP996511		
	DURANGO. 2004-2005				FP996507		
	GRAND CARAVAN. 2008-				FP996511		
FIAT	500. 2008--				FP9091		
FORD	BRONCO II. 1989-1990				FP995512		
	BRONCO. 1992-1996				FP995512		
	CORSAIR. 1989-1992	AP146					
	COUGAR. 1999-2002				FP955026		
	COURIER (PE,PG,PH). 1999-2006	AP191					
	ECONOVAN (JG). 1983-1999	AP120					
	ESCAPE. 2002-			ARM141			
	EXPLORER. 1991-1994				FP995512		
	EXPLORER. 1995-2001				FP995804		
	EXPLORER. 1995-2001				FP955600		
	EXPLORER. 2000-2005	AP187			995206		
	F150. 1992-1996				FP995512		
	F150. 1999-2002				FP995804		
	F150 4 dr. PICK UP. 2001-2002				FP995804		
	F250 2dr.. 1992-1996				FP995512		
	F250 4 dr. PICK UP. 1996-1996				FP995512		
	F250. 1999-2002				FP995804		
	F350. 1992-1996				FP995512		
	F350. 1999-2002				FP995804		
	Fairlane NA,NC. 1988-1995	AP68	AP2	AP12			
	Fairlane NL. 1996-1998	AP69	AP3	AP12			
	FALCON XA-XC. 1972-1979	AP62	AP10A				
	FALCON XD-XE. 1979-1984	AP62	AP10A		FP14		
	FALCON XF. 1984-1993	AP62	AP10A		FP13		
	FALCON AU. 1998-2002	AP67	AP3	AP12	FP9140	AP1053	APP053
	FALCON AU. 1998-2002	AP67	AP3	AP12	FP9141	AP1053	APP053
	FALCON EA, EB, ED. 1988-1994	AP68	AP2	AP12	EA: FP24	AP1692F	APP050
	FALCON EF-EL. 1994-1998	AP69	AP3	AP12		AP7901F	APP051
	FALCON BA. 2002-2005				FP9042		
	FALCON BF. 2005-2008				FP9042		
	FESTIVA Aug 1994- Dec 2000. 1994-2000	AP185					
	FIESTA. 2003-2005				FP9146		APP054
FOCUS. 2003-2004				FP995806			
FOCUS. 2005-2005				FP995808			
FOCUS. 2005-2008				FP9144			
FOCUS. 2005-2008				FP9145			
FOCUS. 2005-2008				FP9145M			
FOCUS. 2008-2010				FP9071			
KA TA, TB (Nov 1999 - Dec 2003). 1999-2003	AP195						
KA. 1999-2009				FP9078B			
KA. 1999-2009				FP9078S			
Laser KQ (April 2001-August 2002). 2001-2002	AP175						
Laser KF-KJ. 1990-1999	AP175						
Laser KC-KE. 1985-1990	AP158						
METEOR. 1985-1987	AP158						
MONDEO. 2007-2010				FP9071			
MUSTANG convertible. 2001-2001				995206			
MUSTANG. 2001-2002				995206			
PROBE. 1993-1997				FP995512			
RANGER. 2007-2010				FP9072			
SPECTRON VAN. 1984-1990	AP120						
TAURUS. 1990-1995				FP995512			
TELSTAR AR. 1983-1985	AP158						
TELSTAR AT-AV. 1987-1992	AP174						
TRANSIT VAN VF-VM. 1996-2009	AP186			FP9144 (2006 ON)			
TRANSIT. 2001-2010							
GREAT WALL	V240. 2009-2010	AP136					
HOLDEN	APOLLO JK-JL. 1989-1993	AP138					
	APOLLO JM-JP. 1993-1997	AP82					
	ASTRA LD. 1987-1989	AP146				APP064	
ASTRA. 1992-1997			ARM054			APP064	





## → AERPRO CROSS-REFERENCE

MAKE	MODEL	MANUAL ANTENNA	AUTO ANTENNA	OEM MAST	FACIA	HARNESS	ISO ADAPTOR
	ASTRA TR-TS HATCHBACK. 1996-2005	AP162					APP064
	ASTRA TR-TS SEDAN. 1996-2005	AP165					APP064
	ASTRA TS COVERTABLE. 2001-2006			AP153			APP064
	ASTRA TS COVERTABLE. 2004-2006			AP153	FP9047 (2004-2005)		APP064
	ASTRA AH. 2006-2009			AP153	FP9048		APP064
	ASTRA AH. 2006-2009			AP153	FP9048B		APP064
	ASTRA AH. 2006-2009			AP153	FP9048S		APP064
	BARINA MF-MH. 1989-1994	AP152					
	BARINA SB. 1994-2001			AP153			
	BARINA SB CABRIO. 1994-2001	AP70	AP6				
	BARINA. 2002-2005				FP9047		
	BARINA. 2002-2009				FP9036		
	BARINA. 2006-				FP993306		
	CALIBRA YE. 1991-1997	AP153					
	CAMIRA JB-JD. 1982-1989	AP72	AP10				
	CAPTIVA SX, CX, LX. 2006-				FP993306		
	COLORADO . 2008-	AP136					
	COMBO VAN XC. 2002-2009	AP153					
	COMMODORE VB-VL. 1978-1988	AP72	AP10				
	COMMODORE VN-VP. 1988-1993	AP70	AP6	AP250		AP1782H	APP060
	COMMODORE VR-VS. 1993-1997	AP70	AP6	AP250		AP1783H	APP061
	COMMODORE VT Series I Sept 97-Jun 99. 1997-1999	AP71	AP7	AP250		AP1784H	APP062
	COMMODORE VT Series II Jun 99-Oct 00. 1999-2000	AP71	APVY1F	AP250		AP1784H	APP062
	COMMODORE VX Series I- II Oct 00-Oct 02. 2000-2002	AP71	APVY1F	AP250		AP1784H	APP062
	COMMODORE VY Series I Oct 02- Aug 03. 2002-2003	AP71	APVY1F	AP250	FP9046		APP064
	COMMODORE VY Series II Aug 03-Jul 04. 2003-2004	AP71	AP9	AP265	FP9046		APP064
	COMMODORE VZ Aug 04 to Aug 06. 2004-2006	AP71	AP9	AP265	FP9046		APP064
	CRUZE. 2009-2010				FP9031		
	CRUZE. 2009-2010				FP9030		
	EPICA. 2006-				FP993306		
	EPICA. 2007-2010						
	GEMINI TX, TG AND ALL MODELS TO 1978. 1975-1978	AP62	AP10A				
	JACKAROO. 1981-1991	AP142					
	JACKAROO. 1992-2003	AP78	AP180				
	NOVA LG. 1994-1996	AP138					
	RODEO KB. 1980-1988	AP142					
	RODEO TF. 1988-2003	AP77	AP176				
	RODEO RA (Single Cab). 2003-2007	AP82					APP063
	RODEO RA (Dual Cab/Space Cab). 2003-2007	AP136					APP063
	SCURRY NB. 1987-2005	AP122					
	SHUTTLE WFR. 1985-1986	AP142					
	TORANA HB-UC. 1967-1979	AP62					
	VECTRA. 2003-2006				FP9047		
HONDA	ACCORD. 1993-2002		AP8	AP251	FP997801	AP1720	APP071
	ACCORD. 2003-2004					707864DZ	APP071
	ACCORD. 2003-2007				FP997864		
	ACCORD EURO. 2004-2010						
	CITY. 2009-2010				FP9074		
	CIVIC. 1973-1985	AP124				AP1720	
	CIVIC. 1992-1998	AP132				AP1720	APP070
	CIVIC. 1999-2000				FP997801		
	CIVIC. 2003--				FP9070		
	CIVIC. 2001-2005				FP997899		
	CIVIC. 2001-2005				FP997865		
	CIVIC. 2006-2010				FP7800		
	CRV. 1997-2001	AP198					APP071
	CRV. 2002-2006	AP198			FP997801		APP071
	CRV. 1996-2001				FP997896		
	CRV. 2007-2010				FP997873		
	INTEGRA. 1990-2001		AP8	AP251	FP997801		
	INTEGRA. 1994-2005		AP8	AP251			
	JAZZ (MANUAL CLIMATE CONTROL). 2003-2007				FP9079		
	JAZZ. 2007--				FP9075		
	LEGEND. 1989-1991			AP251			APP070
	LEGEND. 1990-1995				FP997801		
	ODYSSEY. 1995-2002				FP997801		



# 18 CAR AUDIO ACCESSORIES

## → AERPRO CROSS-REFERENCE

MAKE	MODEL	MANUAL ANTENNA	AUTO ANTENNA	OEM MAST	FACIA	HARNESS	ISO ADAPTOR
	ODYSSEY. 2006-2010						
	PRELUDE. 1983-1988	AP128				AP1720	APP070
	PRELUDE. 1992-2001				FP997801		
HUMMER	H2. 1990-2008				FP952009		
HYUNDAI	ACCENT. 2000-2002	AP181	AP190	AP264	997310		APP086
	ACCENT. 2003-2005	AP181	AP190	AP264			APP086
	ELANTRA. 1997-2000				FP997309		
	ELANTRA. 2000-2005		APXD1F	APXD3M	997313		
	ELANTRA. 2006-2010						
	EXCEL X1. 1985-1989		AP10A			AP1736	
	EXCEL X1. 1986-1981	AP62				AP1736	
	EXCEL X2. 1990-1994	AP83				AP7300	APP081
	EXCEL X3. 1994-2000	AP84				AP7300	APP081
	GETZ . 2003-2007	AP268				AP7350	
	i30. 2007-2010				FP7310		
	i30. 2007-2010				FP7300		
	iLoad. 2005-2010				FP7320		
	IX35. 2010--				FP9035		
	LANTRA J2. 1992-1999	AP184				AP7300	
	SANTA FE. 2001-2005				FP997309		
	SANTA FE. 2007-2008				FP997325		
	SANTA FE. 2006-2010						
	SONATA. 1989-1998	AP62	AP10		997308	AP7300	APP081
	SONATA. 1998-2005		AP178		997313		APP085
	SONATA. 1998-2005		AP178		997313		APP085
	SONATA. 1999-2001				997311		
	SONATA. 2006-2008				FP957320		
	SONATA. 2009-2010				FP9073B		
	SONATA. 2009-2010				FP9073G		
	TIBURON. 1997-2003				FP997309		
	TIBURON. 1997-2003				997308		
	TIBURON. 2003-2005				997313		
	TUCSON. 2005-2009				FP997315		
JAGUAR	ALL MODELS. 1995-			ARM074			
	X TYPE. 2002-2007				FP999500		
	S TYPE. 2003-2006				FP999500		
JEEP	CHEROKE. 1974-2001				FP996700	AP1020	APP020
	CHEROKE. 1997-2001				FP9050	AP1020	APP020
	CHEROKE ( XJ Chassis). 1997-2001	AP168			FP9050	AP1020	APP020
	GRAND CHEROKE. 1996-1998			ARM125	FP9050	AP1020	APP020
	GRAND CHEROKE. 1994-1998			ARM125	FP99600	AP1020	APP020
	GRAND CHEROKE. 2005-2005				FP996507		
	LARADO. 1974-2001				FP996700		
	WRANGLER. 1997-2002				FP9050		
	WRANGLER. 1997-2002				FP996000		
	WRANGLER. 2003-2005				996503		
	WRANGLER. 2007-2007				FP996511		
KIA	CARNIVAL. 2001-2005				FP991005		
	CARNIVAL. 2006-2006				FP957323		
	CERATO. 2009-2010						
	OPTIMA. 2001-2001				997314		
	OPTIMA. 2001-2005				997313		
	RIO. 2001-2001				991003		
	RIO. 2002-2005				FP991007		
	SEDONA. 2002-2003				FP991005		
	SEDONA. 2006-2006				FP957323		
	SEPHIA. 1995-2003				991003		
	SOUL. 2009--				957337B		
	SPECTRA. 2000-2001				991003		
	SPECTRA. 2004-2005				FP991008		
	SPECTRA 5. 2007-2007				FP957330		
	SORENTO LX. 2003-2006				FP991008		
	SORENTO. 2007-				FP957328		
	SORENTO. 2007-				FP997328		
	SPORTAGE. 1995-2003				991003		
	SPORTAGE. 1998-2003			AP273	991003		APP074
	SPORTAGE. 2005-2006				FP997317		





## → AERPRO CROSS-REFERENCE

MAKE	MODEL	MANUAL ANTENNA	AUTO ANTENNA	OEM MAST	FACIA	HARNESS	ISO ADAPTOR
	SPORTAGE. 2009-2010						
LANDROVER	FREELANDER. 2004-				FP9104		
LEXUS	ES300. 1992-1996				FP998150		
	ES300. 1998-2004				FP958156		
	ES SERIES. 1997-2001				FP998155		
	GS300 / 400. 1998-2003				FP998152		
	IS300. 2001-2005				P998151		
	LS. 1995-2000				FP958153		
MAZDA	121. 1990-1996	AP159					
	2. 2008-2010				FP7510		
	323. 1985-1989	AP158					
	323. 1992-1997			AP254		AP7901F	
	323L. 2001-2003				FP9356		
	323K. 2002-2004				FP9356		
	3 SERIES. 2004-2005				FP997504		
	3. 2008-2010						
	3. 2010--				997514B		
	6. 2002-2008						
	6. 2008-2010				FP9066		
	6. 2009-2010						
	626. 1992-1997			AP254		AP7901F	
	626. 1993-1997			ARM052A	995026	AP7901F	
	626. 1993-1997			ARM052A	FP955026	AP7901F	
	626F. 2001-2002				FP9356		
	929. 1988-1991						
	929. 1992-1997		AP10A	AP254		AP7901F	
	B SERIES PICKUP. 1986-1993				FP997501		
	B SERIES PICKUP. 1994-1994				995026		
	B SERIES PICKUP. 1994-1994				FP955026		
	B SERIES. 1995-2002				FP955600		
	B SERIES. 1995-2002				FP995804		
	BT-50. 2007-2010				FP7500		
	CX-7. 2008-2008				FP997508		
	CX-9. 2006--				997516B		
	MPV. 1996-1997				995026		
	MPV. 1996-1997				FP955026		
	MX-3. 1992-1997				995026		
	MX-3. 1992-1997				FP955026		
	MX5. 2001-2004				FP9356		
	MX-6. 1988-1992						
	MX-6. 1993-1996				995026		
	MX-6. 1993-1996				FP955026		
	MPV. 1989-1995				FP997501		
	MPV. 1996-1997				FP955026		
	MPV. 1999-2006				FP997502		
	PROTÉGÉ. 1990-2002						
	PROTÉGÉ. 1995-1995				995026		
	PROTÉGÉ. 1995-1995				FP955026		
	PROTÉGÉ 5. 2002-2002						
	PROTÉGÉ. 2001-2004				FP997505		
	RX7. 1986-1992		AP10A	AP254			
	TRIBUTE. 2001-2002						
	TRIBUTE. 2001-2005				ARM141	FP997505	
	TRIBUTE. 2006-2010					FP9061	
	VAN. 1995-1996	AP146					
MERCEDES	A-CLASS W169. 2005--				FP9092		
	B-CLASS W245. -				FP9092		
	C-CLASS. 2004-				FP9064		
	C-CLASS. 2004-				FP9164		
	C-CLASS W203. 2000-2004				FP9203		
	C-CLASS SPORTS COUPE. 2000-				FP9203		
	C-CLASS. 2001-				FP9203		
	C-CLASS. 2009-2010						
	E-CLASS. 2009-2010						
	CLK. 2004-				FP9064		
	CLK. 2004-				FP9164		
	CLK. 2004-				FP9203		



# 18 CAR AUDIO ACCESSORIES

18 CAR AUDIO ACCESSORIES

## → AERPRO CROSS-REFERENCE

MAKE	MODEL	MANUAL ANTENNA	AUTO ANTENNA	OEM MAST	FACIA	HARNESS	ISO ADAPTOR
	SLK. 37225-				FP9064		
	SLK. 37225-				FP9164		
	S CLASS. 2009-2010						
	SPRINTER. 2000-2006				FP9300		
	SPRINTER. 2006--				FP9092		
	VIANO. 2006--				FP9092		
	VITO W639. -				FP9092		
MG	MG F, TF. 1995-2005			AP153			
MINI	COOPER. 2002-2004				FP999302		APP022
MITSUBISHI	380. 2004-2010				997012		
	COLT. 2004-2008				FP9114	AP7011	
	GALANT Sedan HG-HH. 1989-1993	AP154					APP0110
	GALANT. 1994-1998				FP997001		
	L300 EXPRESS VAN SA-SJ. 1980-1986	AP122				AP7010	APP0110
	LANCER CA,CB, CC. 1989-1996	AP154				AP7010	APP0110
	LANCER . 1993-1994			ARM049		AP7010	APP0110
	LANCER . 1995-1996			ARM073		AP7010	APP0110
	LANCER . 2008-2008			FP997011			
	LANCER HATCH. 2009-2010						
	LANCER SEDAN. 2007-2010				FP9037		
	MAGNA TM,TN,TP. 1985-1991	AP154				AP7010	APP0110
	MAGNA TR,TS. 1991-1996	AP156				AP7010	APP0110
	MAGNA TE-TW. 1996-2005	AP88	AP179	AP253		AP7011	APP0111
	MIRAGE. 1993-2002				FP997001		
	MIRAGE CD. 1998-2005	AP154				AP7011	APP0111
	NIMBUS UF. 1992-2005	AP132				AP7011	APP0111
	OUTLANDER. 2003-2006				FP997001	AP7011	
	OUTLANDER. 2003-2006				FP997008	AP7011	
	OUTLANDER. 2007-2010				997013		
	PAJERO NA-NE. 1983-1987	AP78	AP180	AP253		AP7010	APP0110
	PAJERO NF-NL. 1987-1999			AP253		AP7010	APP0110
	PAJERO. 1994-2000			ARM126		AP7011	APP0111
	PAJERO. 2001-			ARM131		AP7011	APP0111
	PAJERO NM. 2000-2002	AP182		AP262		AP7011	APP0111
	PAJERO. 2008-2010				FP9100		
	VERADA . 2000-2005			AP263		AP7011	APP0111
NISSAN	200SX. 1985-1988				FP997401		
	200SX. 1995-1998				FP997147		
	240SX. 1995-1998				FP997147		
	350Z. 2003-2005				FP997604		
	ALTIMA. 1993-1997				FP997401		
	ALTIMA. 1998-2001				FP997147		
	BLUEBIRD. 1981-1986	AP120					
	DATSUN 180B. 1972-1977	AP142					
	DATSUN 200B. 1977-1981	AP142					
	DATSUN 280ZX. 1979-1984	AP62	AP178				
	DATSUN 300ZX. 1983-1994		AP178	AP252		AP7551	
	DATSUN 300ZX. 1995-2000		AP178	AP252		AP7550	
	DUALIS. 2007-2010						
	FRONTIER. 1998-2004				FP997147		
	FRONTIER. 2005-				FP997581		
	EXTERRA. 2000-2004				FP997147		
	MAXIMA. 1987-1994				FP997401		
	MAXIMA A32-A33. 1995-2003			AP252	FP997147	AP7550	APP0120
	MAXIMA. 1996-1998			ARM088		AP7550	APP0120
	MAXIMA. 1999-2000			ARM123		AP7550	APP0120
	MURANO. 2009--				FP9032		
	NAVARA. 1992-2006	AP81				AP7550	APP0120
	NAVARA IMPORTED DRIVERS SIDE GUARD. 1987-1992	AP80				AP7551	APP0121
	NAVARA D22 Chassis only. 2000-2008	AP183				AP7550	APP0120
	PATHFINDER. 1988-1995	AP81				AP7551	APP0121
	PATHFINDER. 1996-2000				997579		
	PATHFINDER. 1998-2004			AP272	FP997403	AP7550	APP0120
	PATHFINDER R51. 2005-2010						
	PATROL GQ. 1988-1999	AP10		AP252		AP7551	APP0120
	PATROL GU. 1998-2000	AP178		AP252		AP7550	APP0120
	PATROL . 1998-2004			AP272		AP7550	APP0120





## → AERPRO CROSS-REFERENCE

MAKE	MODEL	MANUAL ANTENNA	AUTO ANTENNA	OEM MAST	FACIA	HARNESS	ISO ADAPTOR
	PINTARA SEDAN & SUPERHATCH (NOT WAGON). 1989-1992	AP146				AP7551	APP0121
	PULSAR. 1983-1995				FP997401		
	PULSAR N13 (EXCLUDES SSS & GTIR). 1988-1991	AP146				AP7551	APP0121
	PULSAR N14 (EXCLUDES GTIR). 1991-1995	AP147				AP7551	APP0121
	PULSAR N15. 1995-2000	AP148				AP7550	APP0120
	PULSAR N16. 2000-2005	AP149				AP7550	APP0120
	SKYLINE V35 350GT. 2003-2004				FP997604		
	TIIDA. 2006-2010	G80VS					
	XTRAIL T30 & T31. 2001-2009	AP199				AP7550	APP0120
	XTRAIL. 2007-2010						
PEUGEOT	106. 1992-				FP9106		
	107. -				FP9115		
	206. 1998-2001				FP9206		
	308. -				FP9085		
	406. 1995-				FP9406		
	407. -				FP9115		
PROTON	JUMBUCK. 2002-2009	AP154					
RENAULT	CLIO III. 2005-				FP9245		
	MEGANE. 1996-2002				FP9062B		
	MEGANE. 1996-2002				FP9026G		
	MEGANE. 2004-				FP9245		
	MEGANE. 2007--				FP9086		
	MODUS. 2004-				FP9245		
ROVER	75. 1999-				FP9099		
SAAB	ALL MODELS. 1988-1991			ARM119			APP075
	ALL MODELS. 1992-1996			ARM040A			APP075
SKODA	OCTAVIA. 2007-2010						
	ROOMSTER. 2007-2009						
SMART	FOR TWO. 1998-2007				FP9198		
	FOR FOUR. -				FP9197		
	ROADSTER. -				FP9199		
SUBARU	FORESTER (EXCLUDES GT). 1997-my1999	AP74				AP2001	APP090
	FORESTER . 1998-2004				FP988999	AP2001	APP090
	FORESTER . 2003-2007				FP988999	AP2001	APP090
	FORESTER . 2008-2010				FP958902		APP091
	FORESTER . 2008-2010				FP998902		APP091
	IMPREZA. 1993-2005				FP988999		
	IMPREZA. 1998-2001			ARM110		AP2001	APP090
	IMPREZA. 2007-2010					AP2001	APP091
	IMPREZA WRX. 2002-2005				FP988999		
	IMPREZA WRX. 2008-2008				FP958902		
	IMPREZA WRX. 2008-2008				FP998902		
	LIBERTY, SEDAN. 1989-1994			AP256		AP2001	APP090
	LIBERTY, WAGON. 1989-1994			AP257		AP2001	APP090
	LIBERTY. 2006-2009				FP9089		
	OUTBACK. 2000-2004				FP988999		
SUZUKI	ALTO. 2009--				FP9087		
	IGNIS RG413 (EXCLUDES SPORT). 2000-2005	AP193				AP1130	
	KIZASHI. 2010--				FP9029		
	JIMNY JL, JLX HARD TOP. 1998-2009	AP152				AP1130	APP071
	JIMNY JL, JLX SOFT TOP. 1998-2005	AP192				AP1130	APP071
	SIERRA. 1985-1998	AP122					
	SWIFT. 1995-2001				FP993411		
	SWIFT SF. 1989-1999	AP152					
	SWIFT CINO. 1994-1999	AP152					
	SWIFT. 2005-2010				FP9049	AP1130	APP071
	SX4. 2007-2008				FP997954		
	SX4. 2007-2010						
	VITARA SE416. 1988-2000	AP146					
	VITARA. 2006-					AP1130	APP071
	GRAND VITARA. 1998-2005	AP146				AP1130	APP0130
	GRAND VITARA. 2003-2005	AP146			FP997950	AP1130	APP0130
	GRAND VITARA. 2006-2007				FP957953		
TOYOTA	AVALON MCX10XR Mk1 and 2. 2000-2003			AP270		AP1761	APP0141
	AVENSIS ACM21R. 2000-2003	AP187				AP1761	APP0141
	CAMRY SV21. 1987-1993	AP138	AP178				APP0140



# 18 CAR AUDIO ACCESSORIES

## → AERPRO CROSS-REFERENCE

MAKE	MODEL	MANUAL ANTENNA	AUTO ANTENNA	OEM MAST	FACIA	HARNESS	ISO ADAPTOR
	CAMRY. 1992-1996			ARM050			APP0140
	CAMRY. 2002-2006				FP998203		
	CAMRY. 37468-2010				FP998218		
	CAMRY XV10/SDV10 (EXCLUDES ULTIMA). 1993-1997		AP82				APP0140
	CAMRY MCV20R/SCV20R. 1997-2002	AP196	AP197	AP251		AP1761	APP0141
	CELICA. 1987-1993				FP9065		
	CELICA. 2000-2005				998201		
	COROLLA ZZE122R HATCH. 2001-2007	AP153			FP958204	AP1761	APP0141
	COROLLA ZZE122R SEDAN. 2001-2007	AP187			FP958204	AP1761	APP0141
	COROLLA AE112R HATCH. 1998-2001	AP187			FP993413	AP1761	APP0141
	COROLLA AE112R SEDAN. 1998-2001	AP138			FP993413	AP1761	APP0141
	COROLLA AE101/AE102. 1993-1999	AP138					APP0140
	COROLLA AE101/AE102 Hatch (Twin Headlight). 1998-1999	AP187					APP0141
	ECHO NCP10R. 1999-2003	AP187				AP1761	APP0141
	ECHO. 2000-2005				998201		
	HILUX 4th Generation. 1984-1988	AP60	AP176				APP0140
	HILUX 5th Generation. 1989-1997	AP77	AP178				APP0140
	. 1998-2004	AP188	AP176	AP271		AP1761	APP0141
	HILUX. 2005-2010				FP9016		
	KLUGER GRANDE. 2007--				998222		
	LANDCRUISER. 1990-1998	AP73	AP176	AP255			APP0140
	. 1999-2006		AP176	AP266		AP1761	APP0141
	LEXCEN VN-VS. 1988-1997	AP70	AP6	AP250		AP1783H	APP0140
	MR2. 1991-1995				FP9065		
	MR2 SPYDER. 2000-2002				FP998202		
	PRIUS. 2001-2003	AP187				AP1761	APP0141
	PRIUS. 2004-2008				FP998213		
	PRADO. 1996-2002			AP269		AP1761	APP0141
	RAV-4. 2001-2002				FP998202		
	RUNNER LTD. 2003-2005				FP998210		
	STARLET EP91R. 1996-1999	AP138				AP1761	APP0140
	SUPRA. 1986-1994				FP9065		
	YARIS. 2007-				FP998216		
VOLKSWAGEN	BEETLE. 1970-1978	AP60	AP176				
	BEETLE. 1998-1998				FP9098		
	BEETLE. 1998-2004				998008		
	CRAFTER. -				FP9092		
	GOLF MKI & MKII. 1974-1992		AP178				
	GOLF MK3. 1992-1995	AP161					
	GOLF MK3. 1996-1998	AP153					
	GOLF MK3 CABRIOLET. 1992-2002	AP161					
	GOLF VR6. 1994-1998	AP153					
	GOLF MK4 / 4th Gen - Present. 1998-2009	AP153					
	GOLF. 2000-2006						
	GTI. 2006-				FP999011		
	JETTA. 2006-				FP999011		
	PASSAT MK4 GL. 1995-1997	AP153					
	PASSAT. 2000-2006						
	PASSAT. 2006-				FP999011		
	TOUAREG. 2004-2008				FP999009		
VOLVO	100 SERIES. 1973-1975				FP999222		
	200 SERIES - LOWER DASH. 1975-1993				FP999222		
	200 SERIES - LOWER DASH. 1975-1993				99210		
	200 SERIES - UPPER DASH: LHD. 1980-1993				FP999222		
	740 SERIES. 1985-1992				FP999222		
	760 SERIES. 1983-1988				FP999222		
	S40. 1996-			ARM113A			
	S60. 2005-				FP9067		
	S80. -				FP9068		
	V70. 2005-				FP9067		
	XC70. 2005-				FP9067		
	XC90. -				FP9069		
	ALL MODELS. 1997-1998			ARM114			