



SECTION 19

CB ANTENNA & ACCESSORIES



19

SECTION CONTENTS

↓ Microphones	2
↓ "H" Earpiece Range	4
↓ Communication Speakers	6
↓ Connectors Power	7
↓ Connectors Plugs Sockets	8
↓ Connectors Adaptors	10
↓ Connectors Flyleads	12
↓ RF Cable Premade	13
↓ RF Cable On The Reel	14
↓ Communication Accessories	15
↓ Antenna Bases	16
↓ Antenna Mounting	17
→ Antennas	20
↓ AM/FM	20
↓ DAB + DVB	21
↓ Scanner	22
↓ Amature Radio	23
↓ Marine	24
↓ CB UHF 477MHz	26
↓ Twin Series	31
↓ Cellular	32
↓ AVL & GPS	36
↓ WiFi Antenna	38



→ Microphones

CB MICROPHONE

Push to Talk
Communications
Microphone to suit CB
Radios Requires Plug
(See NC514-4)

Code
DMC508



DMC508 INSERT

15x26mmØ
500Ω -74dB

Code
CDM143

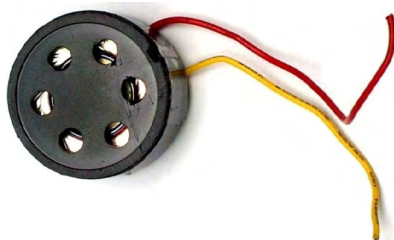

MINI DYNAMIC MIC

Helmet intercoms, etc.
13x19mmØ
400Ω -62dB

Code
DM190



MIC HOLDER CHROMIUM

Screw on type With locking clip.
Suits most mics.

Code
SMH1



MIC HOLDER STAINLESS

Stainless Steel. Screw
on type With locking
clip. Suits most mics.

Code
SMH2



DESK MICROPHONE

ANNOUNCEMENT

Professional Dynamic Microphone.
Weighted base 110x160mm
Metal adjustable goose-neck.
Toggle switch On / Off / Momentary.
Mutes output. 1.5M Lead.
Terminates to 3 pin XLR plug.

Code
DM1



MICROPHONE PLUGS

Type	Code
2 pin	NC514-2
3 pin	NC514-3
4 pin	NC514-4
5 pin	NC514-5
6 pin	NC514-6
7 pin	NC514-7
8 pin	NC514-8



MICROPHONE PLUGS RIGHT ANGLE

Type	Code
2 pin	NC516-2
3 pin	NC516-3
4 pin	NC516-4
5 pin	NC516-5
6 pin	NC516-6
7 pin	NC516-7
8 pin	NC516-8



MICROPHONE INLINE SOCKETS

Type	Code
2 pin	NC518-2
3 pin	NC518-3
4 pin	NC518-4
5 pin	NC518-5
6 pin	NC518-6
7 pin	NC518-7
8 pin	NC518-8



MICROPHONE PANEL MOUNT SOCKETS

Type	Code
2 pin	NC515-2
3 pin	NC515-3
4 pin	NC515-4
5 pin	NC515-5
6 pin	NC515-6
7 pin	NC515-7
8 pin	NC515-8



CURLY CORD

CB mic leads, etc.

Description	Length	Code
3 Core	1.8M (6ft EXT)	ML3-6
3 Core	2.75M (9ft EXT)	ML3-9
3 Core	3.65M (12ft EXT)	ML3-12
5 Core	1.8M (6ft EXT)	ML5-6
5 Core	2.75M (9ft EXT)	ML5-9
5 Core	3.65M (12ft EXT)	ML5-12



SWITCHES & LAMPS

SECTION TWO COMPONENTS

NOW AVAILABLE!

Premium grade
Toggles from
Carlington Switch,
Illuminated SPDT etc.
See Section 2...





→ Microphones

SPEAKER MICROPHONES LIGHT

Remote Speaker Microphone, light weight, superior units designed for light duty applications. Each microphone features a high-quality condenser-style microphone element that produces excellent transmitted audio clarity, as well as a powerful speaker. It may be secured to the user's lapel or shoulder. Built-in jack for using an external earphone.

KENWOOD 2 PIN

Code
RPA2001K1



MOTOROLA 2 PIN

Code
RPA2002



ICOM 2 PIN STRAIGHT

Code
RPA2001S1



ICOM 2 PIN RIGHT-ANGLE

Code
RPA2001S2



VERTEX 1 PIN 2 SCREWS

Code
RPA2001Y4



BENELEC

SPEAKER MICROPHONES SUBMERSIBLE

Benelec 07814

Remote Speaker Microphone, ultra-rugged, superior units designed for all weather applications. Microphone volume controller. Heavy duty industrial grade components and lead. Built for maximum life in maximum circumstances. It may be secured to the user's lapel or shoulder with removable clip.

- Rubber Sealed housing design - Weatherproof IP67
- Ultra Rugged long life design and construction
- 360 degree revolving clip
- Excellent Strain Relief for maximum life in the field
- Heavy Grade Industrial Jacketed Cables
- Excellent transmitted audio clarity
- Volume control on the side



BENELEC MOTOROLA

BL800 & GP328

Code
RPA2111M4



MOTOROLA SIMOCO

GP328 & SRP9180

Code
RPA2111M5



MOTOROLA MOTOTRBO

Code
RPA2111M7



SPEAKER MICROPHONES HEAVY-DUTY

Benelec 07813

Remote Speaker Microphone, rugged, superior units designed for heavy duty applications. Each microphone features a high-quality condenser-style microphone element that produces excellent transmitted audio clarity, as well as a powerful speaker. It may be secured to the user's lapel or shoulder. Built-in jack for using an external earphone.

- Rugged Heavy Duty Construction
- Rubber Side Comfort Grips
- Extra Heavy Duty, Rotating Clip
- Noise Cancelling Design
- External Earphone Jack
- Weatherproof IP54



"H" TERMINATOR

Code
RPA2100H



VERTEX SINGLE PIN

Code
RPA2100Y4



MOTOROLA SOCKET

XTS5000

Code
RPA2100M3J



IN-EAR EXTENSION ADD-ON

Suits RPA2000 Series

Coiled Acoustic In-Ear Piece Inconspicuous clear plastic Electronic transducer speaker Feeds a clear tube the sound. Standard 3.5mm Mono Plug Also suits all of the above RPA microphones



Code
RPA2006

ACOUSTIC EAR TUBE PARTS

Description	Code
Storage carry pouch to suit	RPA2105
Acoustic Ear Tube Assembly	RPA2107
Replacement Earbuds 2 pieces	RPA2103
Quick disconnect plug end	RPA2106



"H" TERMINATOR

Code
RPA2100H



EAR MOLD KIT

REQUIRES INNER-EAR TUBE

Replaces the RPA2103 ear bud. Suits all Acoustic ear-bud sets RPA2006 / 2101 / 2102, etc. This six piece Kit includes Three sizes of L & R ears. 6x Ear molds for extra comfort Secure hold, Extended periods.

Code
RPA2104





→ "H" Earpiece Range

"H" EARPIECE & MICROPHONE PTT

"D" L-MIC EAR W/PTT

Single wire assembly Private conversation Comfortable ear hook Lapel microphone and Separate Push-To-Talk.

Plug	Code
"H"	RPA2108H
M4	RPA2108M4
M7	RPA2108M7
K1	RPA2108K1



"H" HEADSET MICROPHONE & PTT

FINGER STRAP PTT

Single wire assembly Over ear headset suit different users, etc. Lapel microphone and Separate Push-To-Talk Terminates to "H" Plug For universal adaptors

Code
RPA2109H

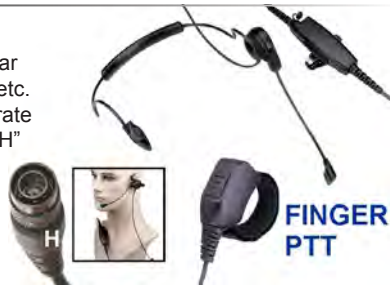

"H" EARPIECE & MICROPHONE PTT

LIGHT WEIGHT EAR HOOK

Soft and skin-friendly ear hook material. PU cable reinforced with Kevlar. PTT & Microphone inline.

Plug	Code
"H"	RPA2112H
E4	RPA2112E4
M4	RPA2112M4
M5	RPA2112M5
M7	RPA2112M7
K1	RPA2112K1



"H" EARPIECE & PTT MICROPHONE

Single wire assembly. Clear plastic tube to Inner ear piece with Push-To-Talk microphone. Speak into PTT Button.

Plug	Code
"H"	RPA2101H
M4	RPA2101M4
M7	RPA2101M7
K1	RPA2101K1



"H" EARPIECE & LAPEL MICROPHONE PTT

LAPEL-MIC EAR W/PTT

Triple wire assembly. Clear plastic tube Inner ear piece with Lapel microphone and separate PTT Button.

Plug	Code
"H"	RPA2102
M4	RPA2102M4
M7	RPA2102M7



ACOUSTIC EAR TUBE PARTS

Description	Code
Storage carry pouch to suit	RPA2105
Acoustic Ear Tube Assembly	RPA2107
Replacement Earbuds 2 pieces	RPA2103
Quick disconnect plug end	RPA2106
Ear Bud Type #2	RPA2104



"H" HELMET KIT

EARPIECE & MICROPHONE

Integrates to Full Face & Open Face Helmets. Push Pull plug/Socket interface for Helmet. Dual Speakers. Strong boom mic clamp, safe and universal. Weather-proof boom microphone and remote. PTT compatible. Loud and robust speaker. Applicable for patrolling officer and motorcycle, motorbike, snow mobile, etc.

Plug	Code
"H"	RPA2114H

See Plug ID Table



"H" HEADSET & MICROPHONE

Ideal for Hard Hats & Helmets. Crystal clear skull microphone - Bone Conduction. Adjustable headband length with Velcro. Easy installation, secure fitting into strap of hard hat.

Plug	Code
"H"	RPA2113H

NO PTT



"H" THROAT MICROPHONE & EARPIECE

Proprietary bone conduction transducer to ensure excellent audio quality and intelligibility. Environmental PU cable reinforced with Kevlar. Comfortable neck band. Quick disconnect. Includes ear tube listening. Requires PTT solution. Terminates to universal "H" plug. Adaptors & PTT available.

Plug	Code
"H"	RPA2116H

NO PTT



"H" PTT

PUSH TO TALK BUTTON

Inline "H" lead with large PTT Button as required by some Helmet and ear pieces.

Plug	Code
"H"	RPA2118



"H" PTT WIRELESS BUTTON

FIT HANDLEBARS STEERING WHEEL ETC.

"H" Input to Motorola. Wire through PTT switch Plus an extra wireless push button remote. Velcro strap affix.

Plug	Code
M3	RPA2119



"H" SPEAKER MIC

WITH "H" PLUG See Below:

Heavy-duty speaker mic communications radio interface system 07813H. Universal "H" termination requires "H" adaptor below. Excellent sound performance. Water resistant moisture seal.

Code
RPA2100H





→ "H" Earpiece Range

"H" HEADPHONE & BOOM MIC

High-attenuating shells with optimised acoustic design and excellent space for the ears for the best possible sound quality and comfort. Microphone with effective noise compensation for clear and reliable communication. Quick positioning integrated microphone boom for easy handling. Soft, wide, foam and fluid-filled ear cushions and individually sprung head band wires of stainless sprung steel provide an even and consistent distribution of pressure around the ears for the best possible comfort. PTT button on the shell.

HIGH NOISE REJECTION

Plug Code
"H" RPA2117HH



"H" NECK BAND HEADSET

Plug Code
"H" RPA2117NH



"H" HELMET ATTACHMENT

Plug Code
"H" RPA2117SH
Helmet NOT Included.
Adaptor plugs available.



"H" PLUG

UNIVERSAL SYSTEM
H-Termination Adaptors
Converts the Universal
Plug into the following:



Plug	Brand	Models	Code
E4	Benelec	BL500	RPA2150E4
K1	Kenwood	TK-220/320, 240/340, 240D/340D, TK-208/308, 430/431, 250/350/353, TK-260/270, 260G/360G, 360/370, 270G/370G, 248/348, 2100/3100 Pro-Talk, 3101 FreeTalk XL, 2102/3102 Pro-Power.	RPA2150K1
K2	Kenwood	TK-280/290, 380/390, 480/481	RPA2150K2
M1	Motorola	GP300, CT450, GTX, SP50, P110, P1225, GP68, PRO3150, LTS2000 GP88, GP308, GP2000, P040, P80	RPA2150M1
M3	EFJohnson Motorola	5100, 7700 Series, HT1000, MTX838, MTX1000, JT1000, MT2000, MTS2000, XTS3000/ Astro, MTX, XTS3500, XTS5000, MT2000, MTS2000, XTS3000, GP900, MTX1000, XTS2500, MTX8000	RPA2150M3
M4	Benelec Motorola	HT750, HT1250LS, HT1550XLS, MTX850LS, MTX950, MTX8250LS, MTX9250, PRO5150, PRO7150, PRO9150, PRO5350, PRO5450, PRO5550, PRO5750, PRO7350, PRO7450, PRO7550, PRO7750, GP328, GP338, GP329, GP339, PTX700, PTX760, PTX780, GP320, GP140, GP340, GP360, GP640, GP680, GP1280	RPA2150M4
M5	Motorola Simoco	EX500, EX600, GL2000, PRO5150elite, GP328plus, GP338plus, GP344, GP388	RPA2150M5
M7	Motorola	Mototrbo XPR6350/6380/6550/6580, APX4000/6000/7000	RPA2150M7
S1	Icom Maxon Uniden GME	IC-F3, IC-F3s, IC-F4, IC-F4s, IC-H2, IC-H6, IC-J12, IC-M5, IC-U12, IC-U16, SP-120/130/140, UH040, UH042, TX6000, TX7000	RPA2150S1
S2	Icom	IC-F3, IC-F3s, IC-F4, IC-F4s, IC-F21	RPA2150S2
S3	Icom, GME	IC-F3G, F3GS, F4G, F4GS, F11, F22, F31, TX6100	RPA2150S3
S6	Icom	IC-F3G, F3GT, F4G, F4GT, IC-41S	RPA2150S6
S8	Simoco	SRP9120, SRP9130, SRP9130 Plus	RPA2150S8
T2	HYT	TC700	RPA2150T2
Y4	Vertex	VX-160, VX-180	RPA2150Y4
Y5	Vertex	BL-820, BLP-820, VX-820, VXP-820	RPA2150Y5



→ Communication Speakers

SPEAKER COMPACT

Polypropylene speaker

Z	8Ω	4Ω
Lead	1.8M	1.8M
Plug	3.5mm	3.5mm
Size	80x65x60mm	80x65x60mm
Power	3 Watt	3 Watt
Code	SP20	SP21



SPEAKER WEATHER RESISTANT COMPACT

With mounting bracket 2Wnom

Z	4Ω
Lead	1.8M
Plug	3.5mm
Size	60mmØ
Power	2Wnom
Code	CS4



BENELEC

SPEAKER RECTANGULAR

With mounting bracket 5Wnom

Z	4Ω
Lead	4.5M
Plug	3.5mm
Size	110x65x55mm
Power	5Wnom
Code	CS8



BENELEC

SPEAKER SQUARE 4Ω

With mounting bracket

Z	4Ω
Lead	1.8M
Plug	3.5mm
Size	125x125x60mm
Power	20Wmax
Code	CS6



BENELEC

SPEAKER SQUARE 8Ω

With mounting bracket

Z	8Ω
Lead	1.8M
Plug	3.5mm
Size	125x125x60mm
Power	20Wmax
Code	CS7



BENELEC

SPEAKER PA HORN

Black Plastic Weather resistant. Public Address Horn Speaker.



Z	8Ω	8Ω	8Ω
Size	150x130mmØ	135x120mmØ	100x90mmØ
Power	15Wmax	10Wmax	10Wmax
Code	PAH1	PAH3180	KPE6127

SPEAKERS REPLACEMENT TYPE

15x55mmØ 8Ω ¼W

Code
SP01



More: For

other drivers See our Speaker Section Six SPEAKERS

MARINE SPEAKER 7"

White Salt-water resistant. One piece construction. Polypropylene driver. 180mm diameter. 75W max power. 4Ω. 5M cable included.

Code
MSPK7



BENELEC

MARINE STEREO SPEAKERS

2-WAY 60W 4Ω 5"

F-Rating Code
120Hz → 20KHz SA502M

2-WAY 80W 4Ω 6"

F-Rating Ω Code
60Hz → 20KHz 4Ω SA602M



MARINE RADIO FACIA

SINGLE DIN SIZED

Weather resistant face suits standard DIN size Stereo, Radio, Com units. Protect from water & dirt. Sealed front flip door. Marine white UV proof.

Code
FP9005



MARINE RADIO HOUSING

SINGLE DIN SIZED

Weather resistant capsule suits standard DIN size Stereo, Radio, Com units. Protect from water & dirt. Sealed front flip door and rear cable entry. Marine white. UV proof.

Code
FP9003



CAR AUDIO ACCESSORIES

SEE SECTION 18 CAR AUDIO ACCESSORIES

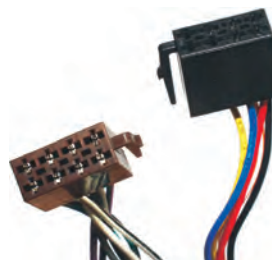

CAR SPEAKERS WIRING LOOMS CAR ANTENNAE MOUNTING PLATES



→ Connectors Power

POWER 12V DC LEAD

3AG 2A Fast Blow Fused
1.2M Black/Red lead

2 PIN

Size	Code
12x6mm	DCL2

2

3 PIN

Size	Code
18x6mm	DCL3

3

DC LEADS CB RADIO

2 PIN POWER

Inline fuse 2A 2M x
18AWG lead White plug:
Square/Round (GME)

Code
DCL510

Arch/Round (Uniden)

Code
DCL505



DCL510

DCL505

DC LEAD T PLUG

2 Pin "T" DC Secure Plug
4mm² x 20 Amp Fused
Suit Icom & Vertex, etc.

Code
DCL507



FUSES LAMPS BEZELS

TOO MANY TO LIST HERE!

See Section 2 COMPONENTS
for values... Glass fuses, Large
& Small Plastic fuses, etc....

FUSE HOLDERS

See Section 2 COMPONENTS

BEZELS

See Section 2 COMPONENTS

 See 02-22
02-23

**SECTION
02**

VOLTAGE NOISE FILTERS

13.8VDC Line suppression
"Square" Box Noise Filter
Engine bay Firewall etc.

Value	Code
5A	NS15S
10A	NS20

"Round" Enclosure (5cmØ)

Value	Code
5A	NS15R

NO Enclosure (Bare Choke Only)

Value	Code
5 Amp	NS5
10 Amp	NS10



IGNITION SUPPRESSOR

Value	Description	Code
0.47µF	Old Condenser type for clamping noise at source.	CNS2
1000µF	Packaged Retail. Polarity protected. With instructions	NS12



24V TO 12V CONVERTERS

AUSTRALIAN GSL MADE Premium
Mobile Quality See Section Eighteen
CAR AUDIO ACCESSORIES !

Power	Code
3A	DC24123
5A	DC24125
7A	DC24127
10A	DC241210

**SECTION
12**

24V TO 12V HIGH POWER

AUSTRALIAN GSL MADE
Switchmode efficiency. See
Section Twelve AC POWER !

Power	Code
20A	DC241220
30A	DC241230
50A	DC241250

**SECTION
12**

BATTERY ISOLATOR

Device for connecting two batteries
to the one charging circuit. Saves
flattening the starter-motor battery.

Type	Code
100A	EBI-100
150A	EBI-150

**SECTION
12**

See Section Twelve AC POWER.

13.8VDC POWER SUPPLIES

Fully regulated Heavy Duty!
Conventional and Switch-Mode available.
See Section 12 AC POWER for details.
A=RMS, Cycled add 50%

Power	Code
4A	SMP30W
10A	SEC1212



SWITCH MODE UNLIMITED!

BATTERY MONITOR/SUPPLY

13.8VDC Charger & Supply
with control circuitry. With
the use of a high power
battery, this unit can supply
10A indefinitely, Higher
current for hours & very
high surge current!

Code
UPS12-10



WIRING SOLUTIONS

CABLE ON A REEL
SEE SECTION 13 CABLE & ACCESSORIES

QUICK DISCONNECTS
SEE SECTION 07 & 18 PLUGS & SOCKETS
& CAR AUDIO ACCESSORIES 18-44





→ Connectors Plugs Sockets

PL259 UHF

Plug	PL259	PL259
Suit	RG58	RG213
Code	PL259A	PL259R



See Section 7 PLUGS & SOCKETS

PL259 CRIMP

Plug	PL259	PL259
Suit	RG58	RG213
Code	PL259-58	PL259-213



SMA CRIMP

Plug	SMA Male	SMA Female
Suit	RG58	RG58
Code	SMA58	SMF58



"N" CRIMP

Plug	"N" Male	"N" Male
Suit	RG58	RG213U
Code	N115	N112



SMA CRIMP

Plug	SMA Male	SMA Male R/A
Suit	RG174	RG174
Code	SMA174	SMA174R



"N" CRIMP

Plug	"N" Male	"N" Male
Suit	RG58	RG213U
Code	N120	N110



SO239 INLINE

Plug	UHF	UHF
Suit	RG58	RG213
Code	IL239-58	IL239-213



SMB CRIMP

Plug	SMB Male	SMB Female
Suit	RG174	RG174
Code	SMB101	SMB105



"N" CRIMP

LL400 (10mmØ)		
Plug	"N" Male	
Suit	LMR400	
Code	N113	



SO239 PANEL

Plug	UHF	UHF
Type	Round	Flange
Code	SO239	SPM239



FME CRIMP

Plug	FME Male	FME Male
Suit	RG58	RG174
Code	FME158	FME8015



"N" CRIMP

Plug	"N" Female	"N" Female
Suit	RG213	LL400
Code	N127	N128



SO239 PANEL

Plug	UHF	UHF
Suit	RG58	RG213
Code	SPM239-58	SPM239-213



FME CRIMP

Plug	FME	FME
	Female	Female
Suit	RG58	RG174
Code	FME100	FME8001



"N" CRIMP

LL400 (10mmØ)		
Plug	"N" Female	
Suit	LMR400	
Code	N129	



MINI-UHF CRIMP

Plug	M259	M259
Suit	RG174	RG58
Code	M259-174	M259-58



"N" CRIMP

Plug	"N" Male	
Suit	RG174	
Code	N7301	



"N" PANEL MOUNT

Plug	"N" Female	"N" Female
Type	Flange	Round
Code	N150	N145

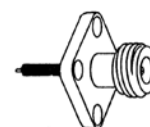

MINI-UHF CRIMP

Plug	S259	
Suit	RG58	
Code	S259-58	



"N" RIGHT ANGLE

Plug	"N" Male	"N" Male
Suit	RG58	RG213
Code	N125	N7302



"N" PANEL MOUNT

REAR CABLE CRIMP		
Plug	Female	Female
Suit	RG58CU	RG213
Code	N152	N154



See Section 7 PLUGS & SOCKETS



→ Connectors Plugs Sockets

TNC CRIMP

Plug	TNC Male	TNC Male
Suit	RG58	RG174
Code	TNC28	TNC7401



BNC CRIMP

Plug	BNC Male	BNC Male	BNC Male
Suit	RG58u	RG58cu	RG174
Code	P659	P660	BNC7001



CRIMPING TOOL

RG58 CRIMP

Crimps 5mmØ Collar
Many ferrule sizes Suit
BNC TNC "N" and others.
See Section 14... TOOLS
& TEST EQUIPMENT

Code
HT336A



TNC CRIMP INLINE

Plug	TNC Female	TNC Female
Suit	RG58	RG174
Code	TNC99	TNC7415



BNC TWIST

Plug	BNC Male	BNC Male
Suit	RG58	RG213
Code	P664	P603



CRIMPING TOOL

RG213 CRIMP And also RG174

Crimps 11mmØ Collar
Many ferrule sizes Heavy
duty ratchet See Section 14
TOOLS & TEST EQUIPMENT

Code
DL801K



TNC CRIMP SOCKET

Plug	TNC Female	TNC Female
Suit	RG58	Solder
Code	TNC45	TNC232



BNC LOAD

50 OHM Terminator

Code
BNT50



COAX CABLE STRIPPER

Insert cable and twist!
Blades can be positioned
for different crimps.

Code
HT377

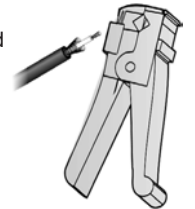

MMCX CRIMP

Micro-Miniature
Crimp Male RG174

Plug	Male MMCX
Suit	RG174
Code	MMCX101



BNC INLINE

Plug	BNC Female	BNC Female
Suit	RG58	RG174
Code	P670	BNC7022



BNC END CAPS

Plug	BNC Male	BNC Female
Code	CP-BNC-M	CP-BNC-F



MMCX CRIMP

FEMALE Crimps to Coax
RG174u RG188u RG316u

Code
MMCX102



BNC PANEL

Plug	BNC Female	BNC Female
Suit	Solder	RG58
Code	J600	J605



N PLUG END CAPS

Plug	N Male	N Female
Code	CP-N-M	CP-N-F



MCX CRIMP

Plug	MCX Male	MCX Male
Suit	RG174	RG58
Code	MCX102	MCX103



BNC BULLHEAD

Colour	Black	Silver
Code	AC-BNC-JJ-75B	AC-BNC-JJ-75



UHF END CAPS

Plug	UHF Male	UHF Female
Code	CP-UHF-M	CP-UHF-F



MCX CRIMP

Plug	MCX Female	MCX Female
Suit	RG58	RG174
Code	MCX112	MCX111



LUCENT MC-CARD PLUG

R/A CRIMP RG174
Lucent WiFi Crimp Suits
MC Cards, etc. LMR100
RG174 Cable

Code
LPC101



SEE SECTION 7

For our entire
range of
adaptors, plugs
& sockets
see Section
7 PLUGS &
SOCKETS





→ Connectors Adaptors

ADAPTORS

Many More Are Available... See Section Seven



SMA/FME

SMA Plug to FME Socket

Code AD1103



SMA/N

SMA Socket to "N" Socket

Code AD1073



SMA/N

SMA Socket to "N" Plug

Code AD1071



SMA/N

SMA Plug to "N" Plug

Code AD1072



SMA/UHF

SMA Male to SO239 Plug

Code AD312



SMA/MCX

SMA Female to MCX Male

Code AD1140



FME/SMA

FME Female to SMA Female

Code AD1104



FME/N

"N" Socket to FME Socket

Code AD1075



FME/FME

FME Female to FME Female

Code AD1111



MCX/N

MCX Male to "N" Male

Code AD1141



MCX/N

MCX Male to "N" Female

Code AD1142



BNC/N FEMALE

BNC Male to "N" Female

Code N156



UHF/UHF

PL259 male to PL259 Male

Code AD2259



"N"/BNC

"N" male to BNC female

Code N155

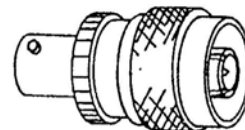

"N"/N

"N" male to "N" male

Code N130

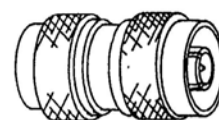

"N" / "N"

"N" female to "N" female

Code N135



"N" / "N" / "N"

"N" T adaptor Male to two females

Code N140

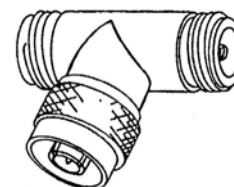

"N"/UHF

"N" male to PL259 female

Code N160

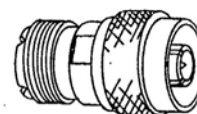

"N"/SMA-RP

"N" Plug to SMA-RP Plug

Code AD1001



"N"/SMA-RP

"N" Plug to SMA-RP Socket

Code AD1006





→ Connectors Adaptors

“N”/TNC-RP

“N” Plug to TNC-RP Plug

Code
AD1042



Mini UHF R/A

Mini UHF Plug → Socket right angle

Code
M259RA

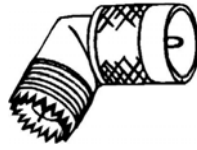

UHF/UHF

PL259 UHF Plug To 2x SO239 “T” Adaptor

Code
PL259T

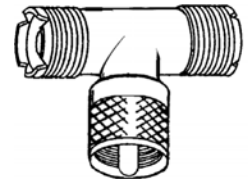

“N”/TNC-RP

“N” Plug to TNC-RP Socket

Code
AD1044



Mini UHF/TNC

Mini UHF male to TNC female

Code
MUF250



UHF/BNC

PL259 plug to BNC socket

Code
AD210

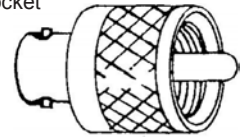

“N”/SMA

“N” Socket to SMA Plug

Code
AD1074



Mini UHF/BNC

Mini UHF Male to BNC female

Code
MUF339



UHF/BNC

BNC plug to SO239 socket

Code
AD240

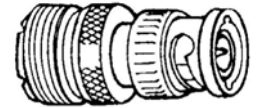

“N”/SMA-RP

“N” Socket to SMA-RP Socket

Code
AD1005



Mini UHF/BNC

Mini UHF Female to BNC male

Code
MUF439

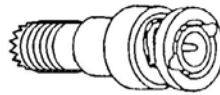

TNC ADAPTORS

Many More Are Available... See Section 7 PLUGS & SOCKETS

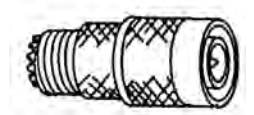

“N”/SMA-RP

“N” Socket to SMA-RP Plug

Code
AD1012



Mini UHF/UHF

Mini UHF male to UHF PL259 female

Code
MUF379

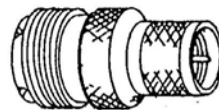

FME ADAPTORS

Many More Are Available... See Section 7 PLUGS & SOCKETS

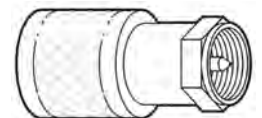

“N”/TNC-RP

“N” Socket to TNC-RP Plug

Code
AD1041



UHF/UHF

Female to female SO239 to SO239

Code
PL258

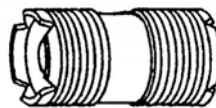

CROSS-REFERENCE LIST

See Section 7 PLUGS & SOCKETS. A quick reference listing of all Adaptors in both from & to ends for convenience.



Mini UHF/SMA

Mini UHF to SMA Female

Code
SMA319



UHF R/A

Right-Angle PL259 → SO239

Code
AD259RA

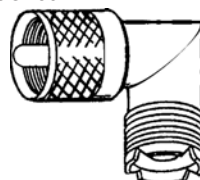



→ Connectors Flyleads

MC LUCENT TO SMA R/P

Plug A MC Lucent Male R/A
 Plug B SMA R/P Female
 Cable RG174U
 Length 0.5M
 Code CAL711



MMCX TO SMA

Plug A MMCX Male R/A
 Plug B SMA Female
 Cable RG174U
 Length 0.5M
 Code CAL808



SMB TO SMA

Plug A SMB Male
 Plug B SMA Female
 Cable RG316U
 Length 0.5M
 Code CAL816



MC LUCENT TO FME

Plug A MC Lucent Male R/A
 Plug B FME Male
 Cable RG174U
 Length 0.5M
 Code CAL712



MMCX TO FME

Plug A MMCX Male
 Plug B FME Male
 Cable RG174U
 Length 0.5M
 Code CAL812



SMB TO FME

Plug A SMB Male
 Plug B FME Male
 Cable RG316U
 Length 0.5M
 Code CAL815



MC LUCENT TO SMA

Plug A MC Lucent Male R/A
 Plug B SMA Female
 Cable RG174U
 Length 0.5M
 Code CAL716



SMK TS-6 TO SMA

Plug A SMK TS-6 Male
 Plug B SMA Female
 Cable RG316U
 Length 0.12M
 Code CAL702



SSMB TO SMA

Plug A SSMB Male R/A
 Plug B SMA Female
 Cable RG316U
 Length 0.5M
 Code CAL819



MCX TO SMA R/P

Plug A MCX Male
 Plug B SMA R/P Female
 Cable RG174U
 Length 0.5M
 Code CAL710



SMK TS-9 R/A TO SMA

Plug A SMK TS-9 Male R/A
 Plug B SMA Female
 Cable RG316U
 Length 0.5M
 Code CAL817



SSMB R/A TO FME

Plug A SSMB Male R/A
 Plug B FME Male
 Cable RG174U
 Length 0.5M
 Code CAL805



MCX TO SMA

Plug A MCX Male
 Plug B SMA Female
 Cable RG174
 Length 0.2M
 Code CAL714



SMK TS-9 R/A TO FME

Plug A SMK TS-9 Male R/A
 Plug B FME Male
 Cable RG174U
 Length 0.5M
 Code CAL811



SSMB TO FME

Plug A SSMB Male
 Plug B FME Male
 Cable RG174U
 Length 0.5M
 Code CAL809



MCX TO 'N'

Plug A MCX Male R/A
 Plug B N Female
 Cable RG174U
 Length 0.2M
 Code CAL715



SMK TS-9 TO FME

Plug A SMK TS-9 Male
 Plug B FME Male
 Cable RG174U
 Length 0.5M
 Code CAL821



CRC9 TO SMA

Plug A CRC9 Male R/A
 Plug B SMA Female
 Cable RG316U
 Length 0.5M
 Code CAL820



MMCX R/A TO FME

Plug A MMCX Male R/A
 Plug B FME Male
 Cable RG174U
 Length 0.5M
 Code CAL807



SMK TS-9 TO SMA

Plug A SMK TS-9 Male
 Plug B SMA Female
 Cable RG316U
 Length 0.5M
 Code CAL822



CRC9 TO FME

Plug A CRC9 Male R/A
 Plug B FME Male
 Cable RG174U
 Length 0.5M
 Code CAL802





→ RF Cable Premade

SMA → SMA LEADS

LOW-LOSS PATCH

LL195 50Ω Coax
SMA Male to Male



Length	Coax	Code
1.5M	LL195	CAL5048
3.0M	LL195	CAL5049
5.0M	LL195	CAL5050

SMA → SMA PANEL MOUNT LEAD

Double nut for panel mounting the Female SMA

Length	Coax	Code
6.0M	LL195	CAL5098



SMA-REVERSED LEADS

50Ω Coax SMA-RP Female to Male

Length	Coax	Code
3.0M	RG58u	CAL5013
3.0M	LL195	CAL5018
5.0M	RG58u	CAL5014
5.0M	LL195	CAL5019
10M	RG58u	CAL5015
10M	LL195	CAL5020
15M	RG58u	CAL5016
15M	LL195	CAL5021
20M	RG58u	CAL5017
20M	LL195	CAL5022



“N” → SMA LEADS

LOW-LOSS PATCH

LL195 50Ω Coax SMA Male to “N” Male

Length	Coax	Code
1.5M	LL195	CAL5060
3.0M	LL195	CAL5043
5.0M	LL195	CAL5044
5.0M	LL400	CAL5080
10M	LL195	CAL5045
10M	LL400	CAL5081
15M	LL195	CAL5046
15M	LL400	CAL5082
20M	LL195	CAL5047
20M	LL400	CAL5083
25M	LL400	CAL5084
30M	LL400	CAL5085



“N” → SMA-REVERSED LEADS

50Ω Coax SMA-RP Male to “N” Male

Length	Coax	Code
3.0M	RG58u	CAL5023
3.0M	LL195	CAL5028
5.0M	RG58u	CAL5024
5.0M	LL195	CAL5029
10M	RG58u	CAL5025
10M	LL195	CAL5030
15M	RG58u	CAL5026
15M	LL195	CAL5031
20M	RG58u	CAL5027
20M	LL195	CAL5032



FME MALE → FEMALE

Length	Coax	Code
1.5M	RG58U	CAL5063
1.5M	LL195	CAL5064
3.0M	RG58U	CAL30
3.0M	LL195	CAL31
5.0M	RG58U	CAL50
5.0M	LL195	CAL51
10M	RG58U	CAL100
10M	LL195	CAL101
20M	LL195	CAL103



“N” → “N” LEADS

50Ω Coax Male to Male

Length	Coax	Code
1.5M	RG58u	CAL5065
1.5M	LL195	CAL5066
3.0M	RG58u	CAL5033
3.0M	LL195	CAL5038
5.0M	RG58u	CAL5034
5.0M	LL195	CAL5039
5.0M	LL400	CAL5070
10M	RG58u	CAL5035
10M	LL195	CAL5040
10M	LL400	CAL5071
15M	RG58u	CAL5036
15M	LL195	CAL5041
15M	LL400	CAL5072
20M	RG58u	CAL5037
20M	LL195	CAL5042
20M	LL400	CAL5073
25M	LL400	CAL5074
30M	LL400	CAL5075



FME → “N” LEADS

50Ω Coax FME Female to “N” Male

Length	Coax	Code
1.5M	RG58u	CAL5061
1.5M	LL195	CAL5062
3.0M	RG58u	CAL5003
3.0M	LL195	CAL5008
5.0M	RG58u	CAL5004
5.0M	LL195	CAL5009
5.0M	LL400	CAL5090
10M	RG58u	CAL5005
10M	LL195	CAL5010
10M	LL400	CAL5091
15M	RG58u	CAL5006
15M	LL195	CAL5011
15M	LL400	CAL5092
20M	RG58u	CAL5007
20M	LL195	CAL5012
20M	LL400	CAL5093
25M	LL400	CAL5094
30M	LL400	CAL5095



BNC → BNC LEADS

50Ω Coax BNC Male to Male

Length	Coax	Code
2.0 metre	RG58CU	CL102
5.0 metre	RG58CU	CL105
10 metre	RG58CU	CL110





→ RF Cable On The Reel

50Ω RG316U COAX

50 ohm mini

Communications Cable. Very small diameter 2.5mmØ. PTFE Dielectrics. FEP Clear Jacket. Full Braided Shield Silver Plated Copper Multi Strand centre.

Length	Code
50M	RG316U-50

AVAILABLE CUT TO LENGTH:

Code
RG316U-1



50Ω RG174/U COAX 2.5mm

Multi-strand steel/copper (0.48mm) with braid tinned copper 90% shield. PE Dielectric (1.5mm). PVC Jacket Black (2.55mm). 100pF/M.

Length	Code
50M	RG174U-50

AVAILABLE CUT TO LENGTH:

Code
RG174U-1



Lossy. Suit very short runs. Flexible.

50Ω RG58AU COAX 5mm

Multi-strand with braided copper shield. Equiv. RG58U

Length	Code
100M	RG58AU

AVAILABLE CUT TO LENGTH:

Code
RG58AU-1



50Ω RG58CU COAX 5mm

Tinned Multi-Strand High-shielding

Length	Code
100M	RG58CU

AVAILABLE CUT TO LENGTH:

Code
RG58CU-1



50Ω LL195 COAX 5mm

LOW-LOSS BROADBAND COMMUNICATIONS CABLE - SOLID CORE

Double shielded with over 93% coverage copper braid + aluminium tape 100%. Gas-Injected Foam Polyethylene 2.79mm insulator. Solid core copper 0.94mm centre suits a majority of crimp plugs, etc. Black polyethylene outdoor flooded weather-proof UV resistant jacket.

AKA	Length	Code
LMR200	100M	LL195

AVAILABLE CUT TO LENGTH:

Code
LL195-1



50Ω RG213U COAX 10mm

HEAVY DUTY with UV-Resistance Tinned Multi-Strand High-shielding.

Length	Code
100M	RG213U

AVAILABLE CUT TO LENGTH:

Code
RG213U-1

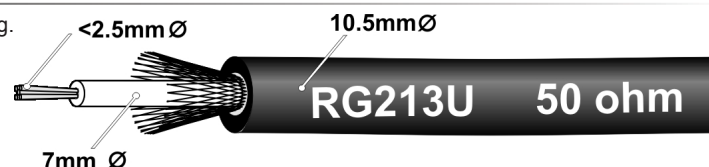

50Ω LL400 COAX 10mm

LOW-LOSS BROADBAND COMMUNICATIONS CABLE, 50 Metre roll

Double shielded with over 93% coverage copper braid + aluminium tape 100% Extra wide bandwidth Gas-Injected Foam Polyethylene 7.25mm insulator Black polyethylene outdoor flooded weather-proof UV resistant jacket Solid core copper 2.75mm centre

Length	Code
50M	LL400
100M	LL402
305M	LL403

AVAILABLE CUT TO LENGTH:

Code
LL400-1

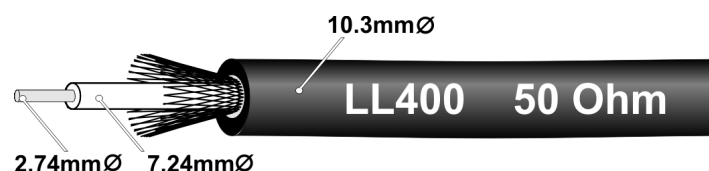



→ Communication Accessories

DUMMY-LOAD

DC-600MHz 50Ω
Non-Inductive
1.15vswr
30W(AVG)
100W(PEP)
Code
RFL101



IMAGE MAY CHANGE FROM :

CABLE CLIPS 6mm - 10mm

ROUND CABLE

Order One to receive 100 (or 20*)

Size	Colour	Code
6mm	White	CC600W
6mm	Black	CC600BK
7mm	White	CC700W
7mm	Black	CC700BK
10mm	White	DQ10



ATTENUATOR -20dB

"N" 3GHz
"N" Male-Female
Full bandwidth 50
Ohm DC-3GHz
20dB Attenuation
Benelec
17203N003
Code
RFL103



CABLE CLIPS STICK-ON 7mm

Adhesive backed clips
Accepts up to 7mm diam
Receive a bag of 10.

Size	Colour	Code
7mm	Black	CTC12



ANTENNA SWITCH PL259

UHF 600MHz
Premium grade cast-iron Wide
band coax switch All SO239
Sockets (x3) Negligible insertion
loss Low SWR. DC-600MHz 500W
50 Ohm. Isolation 60dB
Code
RFL120



CABLE CLIPS STICK-ON 7mm

Adhesive backed clips
Accepts up to 7mm diam
Receive a bag of 10.

Size	Code
7mm	CTC10



ANTENNA SWITCH "N"

"N" 1800MHz
Premium grade cast-iron Wide band
coax switch All "N" Sockets (x3)
Negligible insertion loss Low SWR.
DC-1800MHz 50 Ohm. Isolation 60dB
Code
RFL121



CABLE TIES WITH ANCHOR

Terminates to a ring for
securing with a screw, etc.
Order ONE to receive a
bag of 100 pieces.

Colour	Size	Code
White*	156mm x 3.6mm	NCT140
Black *	156mm x 3.6mm	NCT141



More cable ties are available.
See section 13 Cable for more.



VSWR & POWER METER

1.8MHz-525MHz 200W

Measures SWR and POWER
for optimum antenna tuning,
etc. Peak-Envelope-Power
SSB or Average. Transmitted
& Reflected Power, switched.
Operates on 12-15Vdc
portable, or add a 240V
PowerPack for illuminated
operation, excellent for
permanent installations. Two
pair of PL259 connections for
1.8-180MHz & 140-525MHz.
Power 5W 20W 200W
400W Semi-Professional
full featured Large scale
meter display. 1GL 1Bz 50F
150x65x100mm Requires
Connection leads www.
benelec.com.au 0301

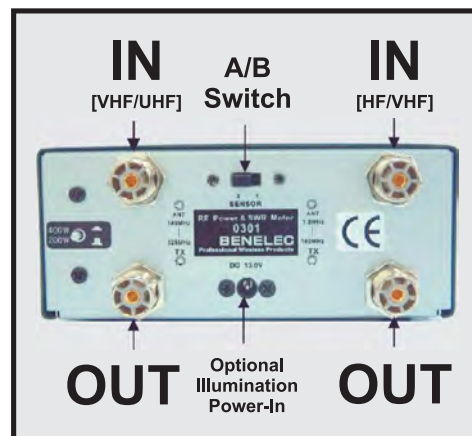

Code
VSWR0301



→ Antenna Bases

CB BASE & LEAD

RG58U 3.6M Coax With 5/16" base

PL259 UHF PLUG

Type	Code
VHF	CBL12
UHF	CBL13



NO-PLUG

Type	Code
UHF	CBL113

SO239 BASE & LEAD

SO239 1/2" Base FME Male Plug LL100 0.4M Coax

Type	Code
UHF	CBL16



FME M→F More 19-12

Length	Code
3.0M	CAL30
5.0M	CAL50
10M	CAL100

SO239 BASE & LEAD

UHF CB BASE

SO239 Socket 5.0M RG58 Coax Suit 1/2" Hole Requires bracket Heatshrink sealed Benelec 10109 Plug FME Female



Length	Code
5.0M	CBL15

CB ANTENNA LEAD 4M

PL259 TO PL259 RG58CU 12ft Coax Cable Professional Reliable Weather proof outdoor Plug to Plug UHF lead Mobile One C12C Coax RG58CU

Length	Code
3.6M	CBL112



MORE COMMUNICATIONS

SEE SECTION 8 PREPARED LEADS

For our complete range of prepared lead assemblies for audio, video and communication.



SEE SECTION 9

ANTENNA ACCESSORIES

TV antenna accessories & antenna.

MOBILE PHONE ACCESSORIES www.cellink.com.au

SEE SECTION 17 CELLULAR ACCESSORIES

For an up-to-date list of all mobile phone models, see our web site at:

www.cellink.com.au



STANDARD CB BASE 5/16"

Ground plane antenna base 1/2" Mounting Hole to 5/16"

VHF 200MHz

Code
CBB2

UHF 520MHz

Code
CBB3



PL259 ANTENNA ADAPTOR

PL259 Female to 5/16" Male Plug an antenna Direct into a SO239 Type Base With Delrin boot Solid brass bolt

Code
CBA272



PL259 ANTENNA BASE 5/16"

GROUNDING SO239 5/16" Antenna to SO239 Socket. Wide bandwidth Suit UHF, etc. Premium grade long-life Delrin weather proof.

Code
CBB6



SO239 ANTENNA BASE

Solder type for affixing PL259 antennas. Wide band UHF Stainless steel.

Code
CBB5



SO239 HEAVY-DUTY BASE

SIDE ENTRY SO239

Large super-heavy-duty side entry SO239 to SO239 base that suits PL259 type antennas. Mobile one SAM2S

Code
CBB102



HEAVY DUTY CB BASE 1/2"

1/2" Bolt through 15mm mounting hole to PL259 Plug. Suitable for 3 & 6ft heavy duty whips. Ground independent 1/2" through-bolt type. Large Delrin base.

Code
CBB4





→ Antenna Mounting

THREADED ANTENNA ADAPTOR

1/2" Female to 5/16" Male

Code
CBA273



BENELEC

5/16" → 3/8" STUD ADAPTOR

Code
CBA274



BENELEC

5/16" → 1/2" STUD ADAPTOR

Solid Brass

Code
CBA270



BENELEC

1/2" → 1/2" STUD ADAPTOR

Stainless Steel

Code
CBA271



BENELEC

HEAVY DUTY GPS BASE 1"

THREADED STUD 1" TO 5/8" WITH NUT

Hollow for coax. Suit marine antennas and some GPS antennas.

Code
CBA275



BENELEC

SPRINGS FOR ANTENNA

High tensile steel springs
Inbuilt shorting straps

5/16" MALE-FEMALE

Width Code
80mm CBS2

1/2" FEMALE-FEMALE

Width Code
105mm CBS3

1/2" HEAVY DUTY !

Width Code
120mm CBS6



FEED ELEVATOR

Centre mount cable feeds through to side for adapting to 1" base.

Code
CBA277



TAIL STRAPS

Anchor units in your vehicle, etc.

170mm Long

Width Code
19mm TS17019

25mm TS17025

340mm Long

Width Code
19mm TS34019

25mm TS34025



ANTENNA HOLE COVER

20mm CAP

Block a hole where a car antenna was. Protects metalwork Stainless steel cap Rubber grommet no-scratch.

Code
CBA28



SELF-AMALGAMATING TAPE

RUBBER BUTYL 40mm

Highly adhesive synthetic rubber & resin based tape cures to a single mass. Seals & water-proofs. Black 40mm x 5 Metres.

Code
SAT140



SELF-AMALGAMATING TAPE

RUBBER-RESIN SEALANT

This is a highly adhesive synthetic rubber and resin based tape that once applied cures into a single mass for sealing and weatherproofing Roll 10 Metres.

Size Code
0.8x18.5mm SFRT10



SELF-AMALGAMATING STRIPS

"COAX-SEAL®" coaxseal.com
Seals & protects connections.
Stays flexible. Remove & re-use.
Military Spec. packaged.

Size Code
12.5x255mm CXS101





→ Antenna Mounting

SUCTION-CUP MAGNETIC BASE

1520MHz 120mmO/D 15mmI/D
Super strong non-scratch UHF base
Suction cap & magnet for extra grip.
Black low-profile. Blank 15mm hole
Suits CB, UHF, Mobile Phones, etc.
Requires antenna attachment.

Code
MB3



GUTTER MOUNT DELUXE

This new heavy duty style is
now suitable for many types of
communication bases (Not Inc.).
SSB, CB, LEOS, UHF, VHF,
Mobile, etc.... Tilts for garage
access, etc.

Code
GM12



GUTTER MOUNT

Chromium plated Metal. Tough
Long-life. Stainless steel Hardware.
Grub screws hold gutter. Tilt/Locks
adjustment. Suits most mounts.

Code
CBA36



GUTTER MOUNT STAINLESS STEEL

Benelec Stainless Steel Metal Tough
Long-life Stainless steel Hardware
Grub screws hold gutter Tilt/Locks adjustment
Suits most mounts.

Code
GM5



BOOT-LIP MOUNT

“S” SHAPED BRACKET

Benelec Black Metal designed for
gripping the trunk lip of a boot.
Grub screws hold. Rubber protected.

Code
TLM5



BOOT LIP MOUNT

STAINLESS STEEL

6 Rubber feet duco
protect. 1/2" hole for
antenna mounting.
Space for cable feed.
Stainless steel, clear or
black powder coated.

Colour	Code
Stainless Steel	MB5
Black Coated	MB4



“L” BRACKET SHORT

STAINLESS STEEL

Vehicle Boot/Bonnet or wall mounting.
Fixed installation of GPI antennas.
Hole 16mmØ with 5.5mm cable entry.
Back plate 45x52mm.
25mm centre to back.

Code
ZB37



“L” BRACKET MEDIUM

STAINLESS STEEL

Wall mounting bracket
16mmØ Hole with 5.5mm cable entry.
Back plate 45x52mm.
60mm centre to back

Code
WB42



“L” BRACKET

1" MOUNTING BRACKET

For mounting antennas on to a wall, etc.
135mm from wall Black

Code
WB40

160mm from wall Stainless

Code
WB41



MOUNTING STRAP

Stainless Steel Suitable
outdoor like boat masts, etc.
Antenna or base mount.

Hole	Size	Code
17mm	340mm	MMM1



MARINE DECK MOUNT BASE 1"

Deck mount base with 2 way tilt
and 1" threaded bolt.

Type	Code
Nylon	MAB1
Brass Chrome Plated	MAB4
Stainless Steel	MAB3





→ Antenna Mounting

POLE BRACKET CROSS

GALVANISED STEEL

Heavy-Duty Right angle bracket. Holds poles from 20mmØ-80mmØ. Includes M12 bolts and washers. Poles shown for illustration (Not inc.)

Code
BB107



MAST BRACKET RIGHT ANGLE

PERPENDICULAR 50/40

Stainless steel
Benelec 02810S
Mast 1 50mm
Mast 2 40mm
Angle 90

Code
BB101



BENELEC

MAST BRACKET

PARALLEL 90/60

Poles 90mm & 60mm Benelec 02811(S) Galvanised Steel.

Code
BB102

Stainless Steel

Code
BB103



BENELEC

MAST BRACKET

UNIVERSAL

Heavy-Duty Bracket. All Stainless steel. Benelec 02815. 2x Poles 32-55mm and/or 9-20mm

Code
BB104

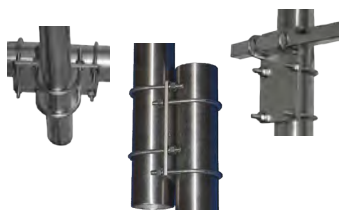

BENELEC

POLE BRACKET PARALLEL

GALVANISED STEEL

Heavy-Duty Parallel hold bracket. Holds poles from 20mmØ-80mmØ. Includes M12 bolts and washers. Poles shown for illustration (Not inc.)

Code
BB108



POLE BRACKET UNIVERSAL

ALL STAINLESS STEEL

Heavy-Duty Parallel or Right Angle. Boom pole from 32mmØ-110mmØ. Mast mount from 43mmØ-62mmØ. Includes M10 bolts and washers. Poles shown for illustration (Not inc.)

Code
BB109



MIRROR MOUNT 1"

Suit ~30mm diameter.

Stainless steel

Code
MM5

Zinc Plated

Code
MM4



BENELEC

BULL BAR BRACKET 2"

Suit mounting on 55mm horizontal poles such as bullbars, etc. "U" bolts have non-slip teeth. Suit most bases. Aus' made zinc.

Code
BB35

Stainless Steel

Code
BB36



BENELEC

BULL BAR BRACKET "LEGAL"

New heavy-duty strap type 316 Stainless steel made Suit most antenna bases 16mm antenna base hole Strap for max 2" pole 2 Holes Vert & Horiz.

Code
BB32



BENELEC

Z BRACKET

Stainless Steel

Code
ZB36

Zinc Plated

Code
ZB35



BENELEC

LIGHTNING ARRESTER

"N" INLINE WITH BRACKET

Replaceable gas capsules. Bulk head for panel mount. With earth lug & bracket. 0.1dB insertion loss. Max power 200W DC to 2500MHz VSWR 1.1 to 1.2.1 60x45x25mm. N Connectors INCLUDES 90V GAS CAPSULE

Code
RFL130



GAS CAPSULE

Match to correct spark over-voltage to your system. Select from Transmitter wattage and system VSWR. BW = 0-1GHz (VSWR<1) 0-2.5GHz(VSWR<1.2). Keep some spares on site for reduced down time.



Volts	VSWR 1:1	1.2:1	1.5:1	3.0:1	Code
90V	28W	22W	20W	12W	RFL130-90
230V	180W	150W	110W	80W	RFL130-230
350V	500W	430W	320W	250W	RFL130-350



↓ Antennas AM/FM

AM/FM ANTENNA 1.0M

950mm BROADCAST RADIO

Tune into common radio Stations AM/FM Units Dual band tuned whip 526KHz - 1.6MHz 88MHz - 108MHz Flexible weatherproof All Australian Made Includes 1.6M of coax Joined. AM/FM Plug and 5/16" Base MobileOne M3P

Length	950mm	950mm
Colour	Black	Black
Type	AM/FM	AM/FM
Base	Common	5/16"
Plug	Car	
Lead	RG62AU	Whip Only
	x1.6M	
Mobileone	M3P	M3W
Code	ANT811	ANT810

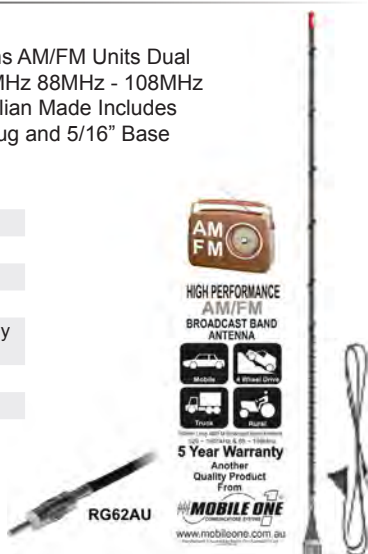

RG68 EXTENSION

Male to Female Car Radio Plug Extension Leads.

Length	0.6M	1.2M	3.6M	5.0M
Code	CAL60	CAL120	CAL360	CAL500



EURO ADAPTOR

Type	Plug	Fly Lead
Code	AD653	CAL653



Other adaptors available. See Secion 18.

DAB+ DIGITAL AUDIO BROADCASTING

DIGITAL RADIO CAN USE DIGITAL TV ANTENNAS

Digital radio using the Digital Audio Broadcasting Plus (DAB+) system operate in the VHF Band III. Specifically, services are currently operating on frequencies in the range 202-212 MHz. Our range of DVB whips for Digital TV are also suitable for DAB+ reception. See DVB Antennas



AM/FM ANTENNA 1.2M

FIBREGLASS WHIP

Antenna receiving AM & FM frequencies of AM 525kHz to 1.6MHz and FM 88 to 108 MHz.

Length	1200mm	1200mm
Colour	Black	Black
Type	AM/FM	AM/FM
Base	Common	5/16"
Plug	Car	
Lead	RG62AU	Whip Only
	x1.6M	
Mobileone	M5P	M5W
Code	ANT886	ANT885



AM/FM ANTENNA 0.3M

FIBREGLASS WHIP

Antenna receiving AM & FM frequencies of AM 525kHz to 1.6MHz and FM 88 to 108 MHz. Available as whip only or with an included base and 1.6M fly lead to standard car antenna plug.

Length	285mm	285mm
Colour	Black	Black
Type	AM/FM	AM/FM
Base	Common	5/16"
Lead	RG62AU x1.6M	Whip Only
Mobileone	M4P	M4W
Code	ANT884	ANT883



AM/FM BOAT WHIP

1700mm BROADCAST RADIO

Tune into common radio stations AM/FM. Tilt Base Swivel for deck or gunwale mount, antenna removeable. Ground-Independent for Fibreglass or wooden boats. Flexible weatherproof. All Australian Made. Includes 3.6M of coax Joined. AM/FM Plug.

Length	1550mm
Gain	2dB
Colour	White
Type	AM/FM
Base	Deck Mount
Plug	Car Radio
Lead	RG62AU x3.6M
Mobileone	M2WMAR
Code	ANT802

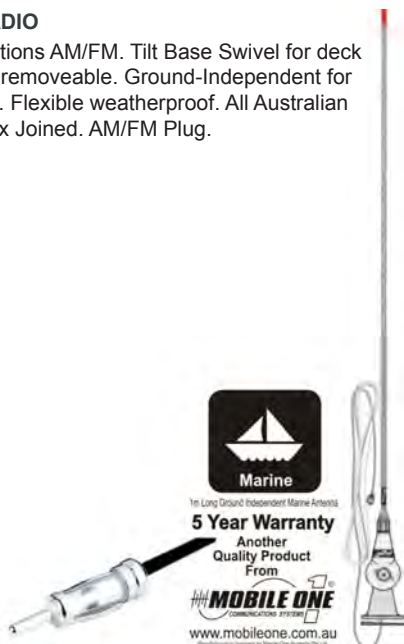

AM/FM ANTENNA 1.5M

FIBREGLASS WHIP

Antenna receiving AM & FM frequencies of AM 525kHz to 1.6MHz and FM 88 to 108 MHz providing 2dB Gain on FM.

Length	1550mm	1550mm
Gain	2dB	2dB
Colour	Black	Black
Type	AM/FM	AM/FM
Base	5/16"	5/16"
Plug	Car	
Lead	RG62AU x1.6M	Whip Only
Mobileone	M2P	M2W
Code	ANT882	ANT881



ECONOMY VERSION

Copy of above antenna.

Length	1100mm
Base	Deck Mount
Lead	4M
Plug	Car Radio
Code	APM03





↓ **DAB + DVB**

DIGITAL TV & DAB WHIP 3dB 830mm

REQUIRES GROUND PLANE

1/2 wave broadband antenna designed for both Digital Radio DAB+ & Digital TV DVB as a mobile antenna UHF-III. Flexible fibreglass whip supplied with standard base & cable assembly 3.6m long. This antenna is NOT Ground Independent. It requires to be mounted onto a metal surface. No plug is supplied.

Length	830mm	830mm
Gain	3dB	3dB
Colour	Black	White
Type	DAB+ DVB	DAB+ DVB
Base	5/16"	5/16"
Plug	BNC	BNC
Lead	3.6M 75Ω	3.6M 75Ω
Mobileone	M206BP	M206WP
Code	ANT847BK	ANT847WH



Note: The use of a spring is not recommended with this antenna as it will reduce the performance.

DIGITAL TV & DAB WHIP 3dB 950mm

GROUND INDEPENDENT BULL BAR MOUNT

1/2 wave, 3dB gain, ground independent, 75Ω impedance antenna that is designed specially for both Digital TV and Digital Radio. It has stainless steel spring base with a 1/2" mounting bolt. Suitable for mounting almost anywhere on a vehicle. 69-220MHz, 510-550MHz.

Length	950mm	950mm
Gain	3dB	3dB
Colour	Black	White
Type	DAB+ DVB	DAB+ DVB
Base	Spring to 1/2"	Spring to 1/2"
Plug	BNC	BNC
Lead	4M RG59	4M RG59
Mobileone	SAN206B	SAN206W
Code	ANT848BK	ANT848WH



DIGITAL TV & DAB WHIP 3dB 1250mm

GROUND INDEPENDENT BULL BAR MOUNT

Hollow fibreglass 1/2 wave ground independent dipole with a stainless steel spring that has a 1/2" mounting. Specially designed for the Digital Radio "DAB+ 9C band" as a base antenna but can be used as a mobile antenna by the use of either a BMS mount or a Z Bracket. 69-220MHz, 510-550MHz.

Length	1250mm	1250mm
Gain	3dB	3dB
Colour	Black	White
Type	DAB+ DVB	DAB+ DVB
Base	1/2"	1/2"
Plug	BNC	BNC
Lead	4M RG59	4M RG59
Mobileone	SS206B	SS206W
Code	ANT849BK	ANT849WH



DIGITAL TV 13.5dB PHASED ARRAY

4 ELEMENT

Excellent ghost rejection high gain for fringe area reception of UHF-III. Forward-back 25dB ratio. Suit Digital Radio and TV. Pole mounting accepts 20mm to 60mm diameter. 850mm x 680mm. Optional booster available. "F" connection.

Type	DAB+ DVB
Gain	13.5dB
Code	AP369F



BOOSTER TO SUIT

Connects directly to AP369 to boost the signal by 14dB. Phantom powered by set-top box, etc. "F" connector.

Gain	14dB	14dB
Volts	5Vdc	12Vdc
Code	BR441	BR411

DIGITAL TV 11dB 9 ELEMENT

COMPACT & LIGHT TO SUIT CARAVANS

VHF/UHF Digital & Analogue reception. Mounts both horizontally and vertically. Bands 3,4 & 5 Channels 6 - 69 AU VHF 174-230MHz / UHF 470-862MHz Maximum gain 9dBi / 11.5dBi Front-to-back ratio 24dB / 32dB Return loss -18dB / -18dB Beamwidth (-3dB) ±23° / ±21° Wind load @120km 3.9Kg 75 ohm. U-Bracket Included. 750(L)x790(W)mm 800g Saddle & Screw (S&S) Coax or "F" Connection



Type	S&S	"F"
Gain	11dB	11dB
Code	LPV345HV	LPV345F

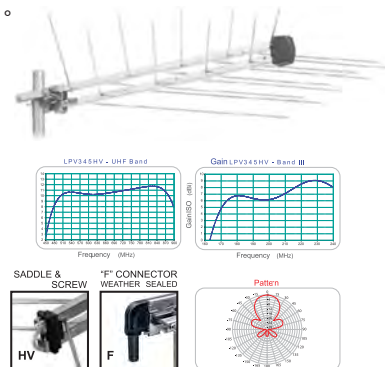

DIGITAL TV ANTENNAS

& ACCESSORIES

More antennas and accessories for TV. Aerial setup including connectors, cable, wall plates, splitters, baluns, boosters, distribution, etc.

See Section 9 Antenna

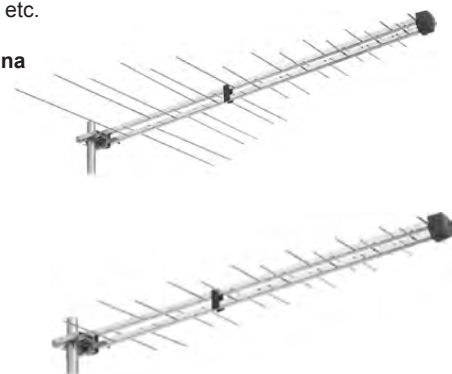



Scanner

SCANNER HAND-HELD

350mm SCANDUCKY

25MHz - 1300MHz
 BNC direct plug hand-held scanner broadband antenna UHF ¼ Wave and VHF & HF helical. Excellent performance tuned for Australian services specifically Air/Emergency/ Commercial. Made in Australia.

Gain	Unity	Unity
Length	350mm	350mm
Colour	Black	Black
Type	Scanner	Scanner
Base	BNC	SMA
Mobileone	BNCSKAN	SMASCAN
Code	ANT872	ANT875



SCANNER MULTI-ELEMENT WHIP

1.2M BROAD-BAND

Multi-element dipole antenna uses a combination of many antennas in one. Designed for extreme broadband use on Airband, low band and high band VHF and the UHF band, It works by the use of various length elements in a dipole configuration similar in concept to a discone antenna. This antenna is ideal for scanning frequencies beyond the common most popular bands and including those bands. Deluxe base station. Hanger tip. Includes fly lead.

Gain	Unity
Length	1200mm
Colour	White
Type	Scanner
Plug	BNC Male
Mobileone	SCBASE
Code	ANT873



SCANNER WHIP ANTENNA SCA

700mm "SCANTENNA"

The Scantenna is a 5/8 wave on a 5/8 wave separated with a 1/4 wave coil producing a 5dB gain on 468MHz and a 1/4 wave on 73MHz which makes for an excellent choice where UHF scanning is the primary band and length of antenna is an issue.

Gain	70MHz to 80MHz 460MHz to 480MHz = 5dB
Length	700mm
Colour	White
Type	Scanner
Base	5/16"
Mobileone	SCA
Code	ANT870



SCANNER WHIP ANTENNA SCATX-LOW

1200mm QUAD BAND 35MHZ TO 440MHZ

Designed especially for UHF & Low band VHF Commercial Bands, Airband, and in some cases can also be used as a transmitting antenna on the following frequencies 415MHz 4.5dB gain, 124MHz 2.14dB gain, 73MHz unity gain and 40MHz 1/4 wave, the SCATX is resonant at these frequencies with a SWR <1.5:1. Note: You should NOT use a spring with this antenna.

Type	Scanner
Gain	35MHz to 55MHz 70MHz to 80MHz 118MHz To 136MHz = 2dB 400MHz to 440MHz = 4.5dB
Colour	Black
Length	1200mm
Base	5/16"
Mobileone	SCATXLOW
Code	ANT880

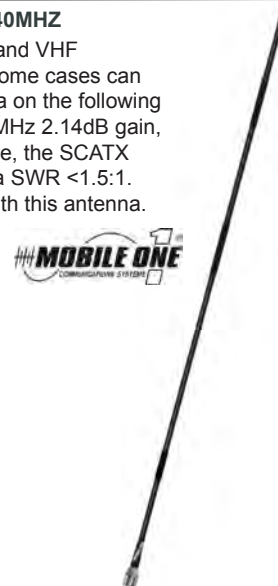

SCANNER WHIP ANTENNA SCATX

1000mm Mobile One SCATX

25MHz - 1300MHz Broadband Heavy Duty Fibreglass Omni whip. True 50Ω Impedance @ 40/72/120/468MHz UHF. Collinear VHF & HF Helical Double 5/8th Wave. Heavy Duty whip Pre-Tuned 5dB. Made in Australia for Australia 1000mm plus Base 5/16"

Note. Requires UHF Base. Not to be used with accessories like a spring or quick disconnect base, etc. Antenna can be mounting under a gutter upside down

Gain	35MHz to 55MHz 70MHz to 80MHz 118MHz To 136MHz = 2dB 460MHz to 480MHz = 4.5dB
Length	1000mm
Colour	Black
Type	Scanner
Base	5/16"
OEM	SCATX
Brand	Mobileone
Code	ANT871



SCANNER WHIP ANTENNA SCATX-HI

Designed especially for UHF Commercial Bands, Hi and low VHF Commercial Bands scanning, and in some cases can also be used as a transmitting antenna on the following frequencies 415MHz 4.5dB gain, 164MHz 2.14dB gain, 73MHz unity gain and 40MHz 1/4 wave. SWR <1.5:1 Note: You should NOT use a spring with this antenna.

Gain	35MHz to 55MHz 70MHz to 80MHz 160MHz To 175MHz = 2dB 400MHz to 440MHz = 4.5dB
Length	1200mm
Colour	Black
Base	5/16"
Mobileone	SCATXHI
Code	ANT879





Scanner

SCANNER WHIP ANTENNA

900mm LAND-MOBILE

Wideband Scanner
21MHz - 900MHz.
Epoxy. Mobile Antenna.
Heavy Duty whip.

Gain	21MHz-900MHz Unity
Length	900mm
Colour	White
Type	Scanner
Base	5/16"
OEM	02627
Brand	Benelec
Code	ANT417

BENELEC

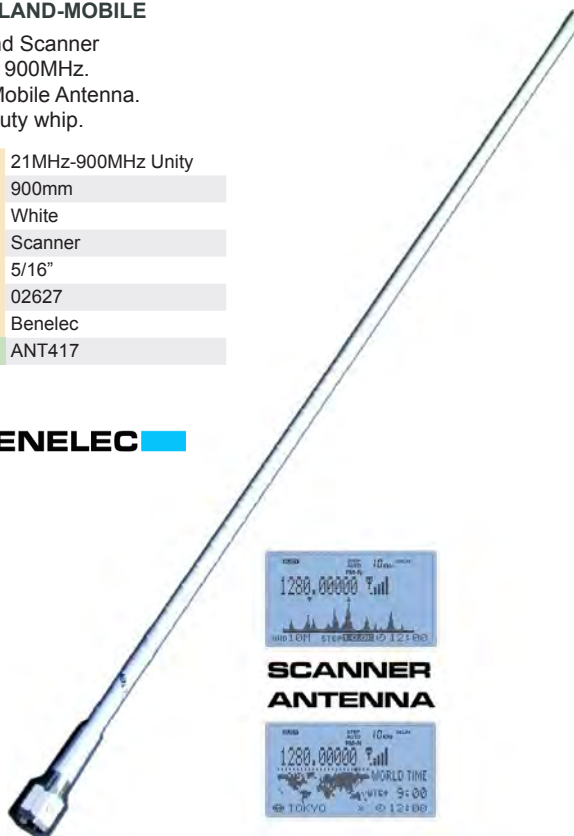

SCANNER BASE STATION DISCONE

DOUBLE SIX ELEMENT 60MHz - 1000MHz

www.benelec.com.au Scanner type Antenna 1000mm in height
900mm in Diameter 1.8dBi Gain Omni Stainless steel Brass fittings
Long life Deluxe Benelec .

Gain	1.8dB
Length	1000mm
Type	Scanner
Base	Pole Mount
OEM	02675
Brand	Benelec
Code	ANT418

BENELEC

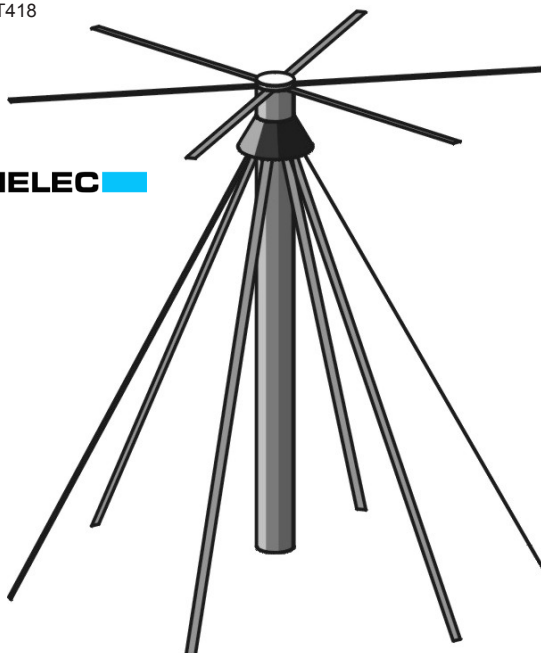

Amature Radio

27MHz WHIPS

27MHz CB

Helically wound, flexible, ground plane dependent antenna whip for use in the 27MHz CB Band.
Copper windings, finished in a black PVC heat shrink coating is very durable and provides waterproofing.
Can be clipped for tuning.
Two lengths available.

BENELEC

Height	3 Ft	5 Ft
Length	915mm	1525mm
Colour	Black	Black
Type	27MHz	27MHz
Gain	0dBi	0dBi
Base	5/16"	5/16"
Benelec	02150	02151
Code	ANT2740	ANT2745



27MHz WHIP REDBACK

DELUXE BENELEC 1M

The Redback is a very slim Helically wound flexible ground plane dependent antenna whip for use in the 27MHz CB Band. It's compact size and low wind resistance makes it appropriate for use in mobile application where space is at a premium. It's copper windings are visible through the clear epoxy coating and contrasts against the black fibreglass to give it an attractive appearance. It's Epoxy coating is very flexible and durable and is resistive to abrasion and ultra-violet radiation.

BENELEC

Gain	0dBi
Length	915mm
Colour	Red
Type	27MHz
Base	5/16"
Benelec	02152
Code	ANT2742



Amature Radio

430-148MHz DUAL BAND HAM ANTENNA

70cm & 2M BANDS 4.5dB

430-440MHz & 144-148MHz Amateur Ham Radio Antenna. Fibreglass whip Australian made quality. Light weight & flexible 4.5dB Low-SWR. 300 Watts. Gutter or boot lip mount. Collinear for 435MHz. Helical for 146MHz.

Gain	4.5dB
Length	700mm
Colour	Black
Type	HAM
Base	5/16"
Mobileone	M270
Code	ANT860





↓ Marine

BOAT WHIPS

WITH DECK BASE

Flexible Fibreglass Whips.
Ground independent.
Includes 12ft Coax. Cable entry is through the base centre. Deck or gunwale mount. Quick tilt & lock base. All parts are off-white Salt water resistant. Chromium steel fittings.

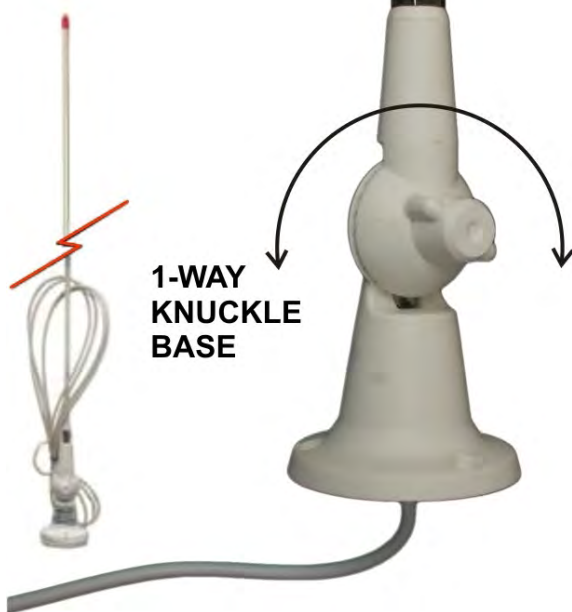

Length	900mm	1390mm	1100mm
Colour	White	White	White
Type	Marine	27MHz	AM/FM
Base	Deck Mount	Deck Mount	Deck Mount
Lead	4M	4M	4M
Plug	PL259	PL259	Car Radio
Code	APM02	APM01	APM03

BOAT WHIP VHF MARINE

960mm 156MHz to 162MHz

Includes tilt base swivel for deck mount. Flexible weatherproof deck or gunwale mounting on fibreglass or wooden boat. All Australian made antenna. Removes from base. Ground-independent VHF marine band antenna 1/2 wave helical monopole. Factory preset tuned 50Ω 100W 156-162MHz. Includes 3.6M of coax joined. PL259 Plug Vswr 1.5:1 MobileOne MD156

Gain	Unity
Length	960mm
Colour	White
Type	Marine VHF
Base	Deck Mount
Mobileone	MD156
Code	ANT820

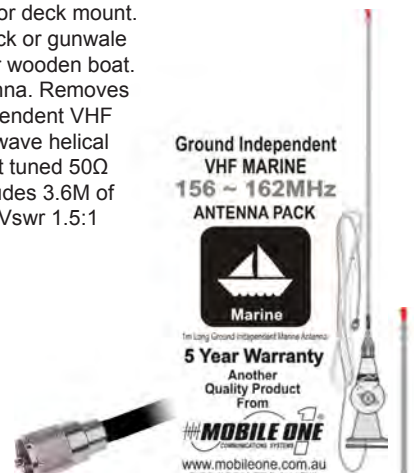

BOAT WHIP 27MHz

1900mm 27.8 - 28.3MHz

Includes Tilt Base Swivel for deck mount. Flexible & Weatherproof Deck or Gunwale mounting to suit Fibreglass or wooden boat. All Australian Made Antenna. Removes from base. Ground-Independent. CB Band 27MHz Radio 1/4 Wave. Helical Monopole. Factory preset tuned. 50Ω 100W Transmit Max. Includes 3.6M of coax Joined. PL259 Plug Vswr 1.5:1

Gain	3dB
Length	1900mm
Colour	White
Type	CB 27MHz
Base	Deck Mount
OEM	MA277
Brand	Mobileone
Code	ANT801



BOAT WHIP VHF MARINE

900mm 156MHz to 162MHz

Unity gain 3dB marine band for boat mast mount or cabin mount with 90cm whip. Long-life robust weather proof stainless steel Delrin protected UHF PL259 socket. Requires lead Benelec 02522.

Gain	3dB
Length	900mm
Colour	Steel
Type	Marine
Base	SO239
Benelec	02522
Code	ANT600



AM/FM BOAT WHIP

1700mm BROADCAST RADIO

Tune into common radio stations AM/FM. Unit includes tilt base swivel for deck mount. Flexible weatherproof deck or gunwale mounting on fibreglass or wooden boat. All Australian made antenna. Removes from base. Ground-Independent. Includes 3.6M of coax joined. AM/FM Plug MobileOne M2WWMAR

Gain	2dB
Length	1550mm
Colour	White
Type	AM/FM
Base	Deck Mount
Lead	RG62AU x3.6M
Plug	Car Radio
Mobileone	M2WWMAR
Code	ANT802





↓ Marine

BOAT WHIPS 1.8M MATCHING RANGE

1" BASE + ELEVATED FEED & 5M COAX

6 Foot 1.8M Salt water resistant Heavy duty radome Fibreglass. Chrome plated brass fittings. Ground independent Antenna. All are consistent appearance for multiple antenna mounting. 1" Threaded base. Side cable entry. Includes 5 metres coax connected. May require a connection plug or adaptor.

BENELEC



Type	27MHz	Marine	NextG 850 GSM900 GSM1800 LTE 4G 3G-2100	GSM900	AM/FM	UHF
Length	1800mm	1800mm	1800mm	1800mm	1800mm	1800mm
Gain	2dBi	3dBi	3dBi	3dBi	3dBi	3dBi
Colour	White	White	White	White	White	White
Base	1"	1"	1"	1"	1"	1"
Lead	RG58CU x5M	RG58CU x5M	LL195 x5M	RG58CU x5M	RG62A x5M	RG58U x5M
Plug	PL259	No Plug	FME	No Plug	No Plug	No Plug
Benelec Code	02129	02523	02462	02462G	02362	02662
Code	ANT601	ANT602	ANT603	ANT604	ANT605	ANT606

MORE WHITE WHIPS

UHF 477MHz & CELLULAR

Premium grade white radome fibreglass heavy-duty whips with assorted bases are available, including new "Twin" series for having matching pairs of antennas.

See UHF 477MHz...

See Cellular Antennas...



TWO-WAY KNUCKLE

Glass filled white nylon salt water proof. Locking arm. Tilts forward, back and side to side. 1" Stud mount.

Code
MAB1

BENELEC



TWO-WAY KNUCKLE STAINLESS STEEL

DECK MOUNT 1" STUD

Premium grade polished stainless steel. Locking arm. Tilts forward, back and side to side. 1" Stud mount.

Code
MAB3

BENELEC



TWO-WAY KNUCKLE BRASS CHROME

DECK MOUNT 1" STUD

Chrome plated solid brass. Locking arm. Tilts forward, back and side to side. 1" Stud mount.

Code
MAB4

BENELEC



RAIL MOUNT KNUCKLE

DECK MOUNT 1" STUD

Premium grade polished stainless steel. Locking arm. Tilts forward and back. 1" Stud mount.

Code
MAB5

BENELEC



MOUNTING STRIP TO SUIT

Stainless steel used on boat masts.

Hole 17mm
Size 340mm
Code MMM1

More strips available. See previous pages.



THREADED 1" STUD

Hollow 1" [to 5/8" & Nut]

Code
CBA275

BENELEC



FEED ELEVATOR

1" MALE - FEMALE
Centre mount cable feeds through to side for adapting to 1" base.

Code
CBA277

BENELEC





19 COMMUNICATIONS ACCESSORIES

19 COMMUNICATIONS ACCESSORIES

↓ CB UHF 477MHz

UHF RUBBER-DUCKY 300mm

477MHz 4dB 1/2" BASE

Flexible & Robust Ground Independent low-profile, tough No ground plane 0dB With ground plane 4dB Australian made. Nylon radome black Boats, trucks, cars, 4-wheel, farm, etc. BW=20MHz. Vswr 1.8:1

Type	477MHz	477MHz
Gain	4dB*	4dB*
Length	300mm	300mm
Base	SO239	Tail
Colour	Black	Black
Plug	PL259	PL259
Lead	Coax x5M	
Benelec	02634XC	02634X
Code	ANT435	ANT434



UHF RUBBER-DUCKY 360mm

477MHz 2dB 1/2" BASE

Flexible type with spring base for a low-profile, tough mount anywhere! 300W BW=15MHz 2dB *Ground Independent. Only 360mm tall. Australian made.

Gain	*2dB	*2dB
Length	360mm	360mm
Colour	Black	Black
Type	477MHz	477MHz
Base	Tail 3.6M	PL259
Plug	PL259	PL259
MobileOne	CD470	CD470PL
Code	ANT410	ANT823



UHF HAND HELD 150mm

Direct to plug connection. Ground independent 1/2 wave. Made with tough nylon tubing covered with polyolefin. This antenna is primarily for hand held transceivers but can be used in other applications where an inline antenna is required.



Length	160mm	160mm	160mm
Gain	1/4 Wave	1/4 Wave	1/4 Wave
Colour	Black	Black	Black
Type	477MHz	477MHz	477MHz
Base	BNC	TNC	SMA
Mobileone	BNCMD	TNCMD	SMAMD
Code	ANT844	ANT845	ANT846

UHF HAND HELD 350mm

1/2 wave ground plane independent antenna with a SMA connector designed especially for exposed SMA connectors on hand held radios. Covered entirely with polyolefin rubber heatshrink for heavy duty use and weatherproof protection.

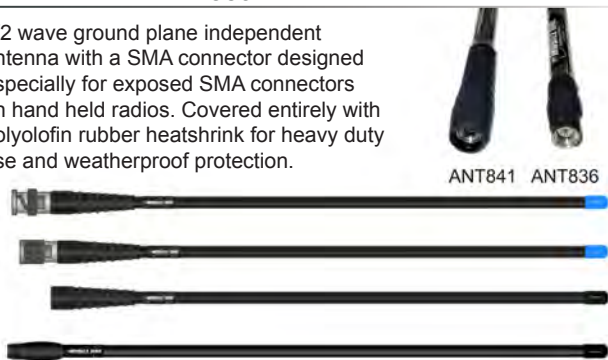

Gain	3dB	3dB	3dB	3dB
Length	350mm	350mm	350mm	350mm
Colour	Black	Black	Black	Black
Type	477MHz	477MHz	477MHz	477MHz
Base	BNC	TNC	SMA (up)	SMA (in)
Mobileone	BNCHW	TNCHW	SMAIHW	SMAHW
Code	ANT837	ANT838	ANT836	ANT841

UHF INVISIBLE 2.5dB

WINDOW MOUNT

477MHz coaxial dipole UHF clear transparent on-glass UHF antenna. Vandal proof. Mounts on the inside of a vehicle windscreen. 460MHz - 470MHz 2.5dBi Max power rating 25 watts. Covert & no wind noise. Includes 3.6M low-loss coax to PL259 plug. Long thin style to suit front, side rear windows.



Gain	2.5dB
Length	3600mm
Type	477MHz
Base	Sticker
Plug	PL259
OEM	472
Brand	Laser
Code	ANT901



UHF INVISIBLE 4.5dB

WINDOW MOUNT DOUBLE

Discreet 477MHz antenna. High performance full-wave dual pole with common centre. Omni-directional wide-band clear mylar/polyester transparent for on-glass. UHF antenna vandal proof. Mounts on the inside of a vehicle window glass. 390MHz - 520MHz 4.5dBi. Max power rating 25 watts Vswr 1.2:1 at 477MHz. Covert & no wind noise. Includes 3.6M low-loss coax to PL259 Plug. Long thin style to suit front, side rear windows.



Gain	4.5dB
Length	3600mm
Type	Window Mount
Base	Sticker
Plug	PL259
OEM	477
Brand	Laser
Code	ANT902

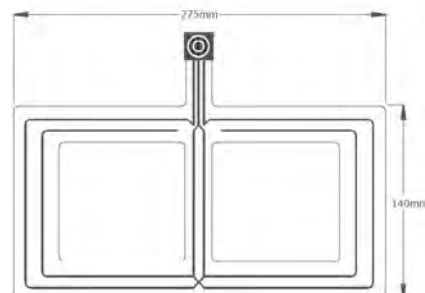



↓ **CB UHF 477MHz**

UHF STAINLESS STEEL WHIP 4.5dB

5/16" THREADED BASE

17-7PH Grade 2.5mmØ
Tuned Spring 470-490MHz

Gain	4.5dB	4.5dB
Length	670mm	670mm
Colour	Stainless Steel	Black
Type	477MHz	477MHz
Base	5/16"	5/16"
Benelec	026231	026231BK
Code	ANT415	ANT415BK

Suit: Replacement or stand-alone



UHF STAINLESS STEEL WHIP 4.5dB

5/16" THREADED BASE

17-7PH Grade 3.5mmØ
Tuned Spring 470-490MHz

Gain	4.5dB	4.5dB
Length	600mm	600mm
Colour	Stainless Steel	Black
Type	477MHz	477MHz
Base	5/16"	5/16"
Mobileone	S474	S474B
Code	ANT822	ANT833

Suit: Replacement or stand-alone



UHF STEEL WHIP 6.5dB

477MHz 870mm

870mm Stainless 17/7 High Tensile Plated Brass. Ferrule Terminates to SO239. 0.5mmØ Black Delrin. Ground plane independent. Elevated Ferrule. Includes SO239 Base and lead assembly to FME Socket.

Gain	6.5dB
Length	870mm
Colour	Steel
Type	477MHz
Base	SO239
Lead	5Mx RG58
Plug	FME Socket
Benelec	02632
Code	ANT433



UHF ELEVATED-FEED STEEL WHIP

477MHz 240 & 760mm 6.5dB

Benelec "Truckie" whip set. Suit mirror/ bull mount. Stainless steel whip. Brass & Delrin Base. Elevated feed tube. High tensile strength. Mobile Truckie Antenna. Ground Independent. Suit high speed mount gutter / mirror / boot. Low-Loss coax connected Centre feed cable 5.0M Terminates to PL259 Plug ¼ Wave Vswr 1.5:1 6.5dB 477MHz Bandwidth 13MHz Plug Lead Base 2x Whips.

Gain	6.5dB
Length	760mm
Colour	Steel
Type	477MHz
Base	½"
Benelec	02637
Code	ANT436



UHF STEEL WHIP 9dB

477MHz 1300mm

1300mm Stainless 17/7 High Tensile 0.5mmØ Black Delrin Suit 4x4, trucks, etc. Best bull bar mounting. Ground plane independent. Includes elevated base. Require ½" Bracket mount. Includes low loss cable. Terminates to PL259 Benelec 02629

Gain	9dB
Length	1300mm
Colour	Black
Type	477MHz
Base	SO239
OEM	02629
Brand	Benelec
Code	ANT432



UHF STEEL WHIP 6dB

477MHz 890mm GAIN-MASTER

Ground plane independent stainless steel collinear 89cm 6.5dB. 200W 477MHz Elevated spring base kit 3.2mmØ Stainless steel. Popular for industrial, mining, heavy transport, because of its durability, impressive steel elevator and long-life construction. Australian made. High grade steel, brass and plastics Terminates to SO239 socket. Lead required. Direct mount to ½" bracket. Requires lead, plug, etc. 1.5:1 VSWR 15MHz BW Mobile or base station.

Gain	6dB
Length	890mm
Colour	Stainless Steel
Type	477MHz
Base	PL259
OEM	RF470COMBI
Brand	MobileOne
Code	ANT428



STEEL WHIP
477MHz
Ground Independent
6.5dB Gain
UHF CB Antenna

5 Year Warranty
Another Quality Product From
MOBILE ONE
COMMUNICATIONS SYSTEMS
www.mobileone.com.au



↓ CB UHF 477MHz

UHF FIBREGLASS 1M 6.5dB

HEAVY DUTY SPRING

Supplied complete with a robust Mobile Spring Assembly making it ideally suited to a range of optional mobile mountings complimentary to most vehicle applications. Offers a stable genuine radiation pattern with negligible horizontal pattern tilt.

Gain	6.5dB	6.5dB
Length	1110mm	1110mm
Colour	Black	White
Type	UHF 477MHz	UHF 477MHz
Base	Fixed Spring	Fixed Spring
Plug	FME/PL259	FME/PL259
Lead	5M RG58	5M RG58
Benelec	026385	026385WT
Code	ANT531BK	ANT531WH

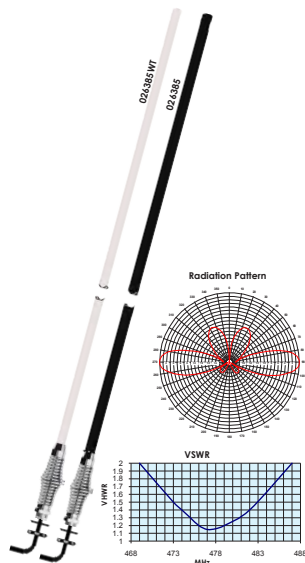

Available in different lengths, detachable whip and in Cellular. See Benelec Twin series...



UHF DESERT STICK 2M 8dB

HEAVY DUTY SPRING

High gain performance in a ruggedised package. Includes polished stainless steel mounting section, ultra heavy duty stainless steel spring, and a heavy walled fibreglass radome whip. Comes complete with a feed lead in a small diameter cable, fitted at one end with an FME connector, allowing easy installation through the vehicle.

The antenna has a flying lead with a new generation waterproof push-pull connector for easy termination to the feed cable lead, making the antenna fully removable.

Gain	8dB	8dB
Length	1.8M	1.8M
Colour	Black	White
Type	UHF 477MHz	UHF 477MHz
Base	Spring	Spring
Plug	FME / PL259	FME / PL259
Lead	5M	5M
Benelec	026386K	026386K
Code	ANT533BK	ANT533WH



UHF WHIP 1900mm DESERT STICK

8dB 477MHz 1.9M KIT

Deluxe construction Heavy-Duty 4WD whip. Fibreglass Radome. All copper internal. Supplied as a kit Includes spring. Requires 1/2" Base (hole) Stainless Steel Mounting tube to side entry cable. Short FME Tail to 5M of LL195 fly lead UHF PL259 Adaptor Tuned 477MHz Bandwidth 9MHz Benelec 026386K

Gain	8dB	8dB
Length	1900mm	1900mm
Colour	White	Black
Type	477MHz	477MHz
Base	1/2"	1/2"
Plug	PL259	PL259
Benelec	026386K	026386K
Code	ANT430	ANT439



UHF ELEVATED-FEED WHIP

1/2" Base with Spring COUNTRY / CITY KIT

Elevated feed spring base fibreglass whip 600mm and a stubby 150mm. (Country/City) 5M attached lead. 1/2" mounting nut. Requires bracket. No ground plane required. Australian Made. Requires plug see Section 7 PLUGS & SOCKETS

Gain	3dB/6.5dB
Length	450/600mm
Colour	Steel & Black
Type	Elevated-Feed
Base	Spring 1/2"
Lead	5M RG58
Plug	FME PL259
Benelec	02635
Code	ANT420



UHF BASE STATION 2.4M

477MHz 6dB LONG RANGE

2400mm long antenna for High Gain. Co-Linear. Designed for base station applications. Also suitable for boats, etc. "N" Plug terminated base. Heavy Duty tapered hollow fibreglass Radome aluminium and copper made. 160Km Wind load. 4.6Kg. 477MHz Bandwidth 3MHz. Vertical beam 16 Deg. Requires mounting hardware, etc. Antenna only.

Gain	6dB
Type	477MHz
Base	"N" Female
Length	2400mm
Benelec	02648
Code	ANT416



UHF ELEVATED-FEED 6dB

477MHz 880mm GAIN-MASTER

880mm fibreglass 6.5dB 200W collinear. Antenna base kit elevated with centre feed. Ground plane independent. DC grounded for protection. Suit trucks, rural, four wheelers, boats, or as a base station, etc. Lead through centre of base heavy-duty steel spring 3.6M coax to PL259 Plug Base requires 1/2" bracket Mobile One.

Gain	6dB	6dB
Length	810mm	810mm
Colour	Black	White
Type	477MHz	477MHz
Base	Spring	Spring
	Elevated	Elevated
OEM	RF470FWSS	RF470FWSS
Brand	Mobileone	Mobileone
Code	ANT824BK	ANT824WH



477MHz Ground Independent 6.5dB Gain UHF CB Antenna

5 Year Warranty Another Quality Product From MOBILE ONE



↓ CB UHF 477MHz

UHF HEAVY DUTY WHIP 1M 4.5dB

477MHz WHITE WHIP 950mm

Ground Plane Independent. Heavy duty spring base. Excellent general purpose heavy duty fibreglass whip. Wide tapered strong radome for light weight & strength. High performance. 4dB gain. Terminates to PL259 Plug or SO239 UHF socket. Suit all vehicles on land or marine, bull-bar or mast. Long life design. Low SWR. Made in Australia. Mobile-One. DC Grounded for safety.

Gain	4.5dB	4.5dB
Length	950mm	950mm
Colour	White	Black
Type	477MHz	477MHz
Base	SO239	SO239
Plug	PL259	PL259
OEM	CL474WCOMBI	CL474BCOMBI
Brand	MobileOne	MobileOne
Code	ANT423	ANT828



UHF RAYDOME WHIP 1.6M 6dB

477MHz 1600mm KIT

1600mm Fibreglass 6dB Collinear. 200W Max. Ground plane independent DC grounded for protection For use as a mobile whip 4x4, trucks, rural, etc. Direct PL259 Plug end Requires SO239 Base Requires cable, etc. Mobile One CP476W

Gain	6dB	6dB
Length	1550mm	1550mm
Colour	White	Black
Type	477MHz	477MHz
Base	SO239	SO239
Plug	PL259	PL259
OEM	CP476W	CP476B
Brand	MobileOne	MobileOne
Code	ANT421	ANT830



UHF RAYDOME WHIP & SPRING 1.1M 4.5dB

477MHz 1100mm KIT

1200mm fibreglass 4.5dB 200W collinear. Spring Base. PL259 Ground plane independent DC grounded for protection Extra Heavy duty sprung for use as a mobile whip 4x4, trucks, rural, etc. Direct PL259 Plug end Requires SO239 Base Requires cable, etc. Mobile One CP474S

Gain	4.5dB	4.5dB
Length	1100mm	1100mm
Colour	White	Black
Type	477MHz	477MHz
Base	SO239	SO239
Plug	PL259	PL259
OEM	CP474SW	CP474SB
Brand	MobileOne	MobileOne
Code	ANT835	ANT834



UHF RAYDOME WHIP & SPRING 1.6M 6dB

477MHz 1600mm WITH SPRING

1600mm Fibreglass 6dB 200W Collinear. Spring Base Ground plane independent DC grounded for protection Extra Heavy duty sprung for use as a mobile whip 4x4, trucks, rural, etc. Direct PL259 Plug end Requires SO239 Base Requires cable, etc. Mobile One CP476S

Gain	6dB	6dB
Length	1600mm	1600mm
Colour	White	Black
Type	477MHz	477MHz
Base	SO239	SO239
Plug	PL239	PL239
OEM	CP476SW	CP476SB
Brand	MobileOne	MobileOne
Code	ANT832	ANT831



UHF WHIP & SPRING 950mm 4.5dB

477MHz 950mm KIT

Lightweight flexible short whip 50W max. Ground independent collinear UHF. Low SWR 1/2 wave low angle of radiation. Bull-bar, boat mount flexible fibreglass whip on a spring base. DC Grounded. Made In Australia. 1/2" hole bracket required. VSWR 1.5:1 BW=10MHz. PL259 Plug supplied.

Colour	White	Black
Gain	4.5dB	4.5dB
Length	950mm	950mm
Type	477MHz	477MHz
Base	1/2"	1/2"
Lead	3.6M RG58	3.6M RG58
Plug	PL259	PL259
Mobileone	CL474SW	CL474SB
Code	ANT827	ANT826



UHF ELEVATED-FEED & SPRING 1680mm 6dB

477MHz 1680mm KIT

Fibreglass 6dB 200W Collinear. Elevated spring Base included. Ground plane independent. Suit trucks, rural, four wheelers, boats, or as a base station, etc. DC grounded for protection. Lead side-entry above spring. 3.6M coax to PL259 Plug Base requires 1/2" bracket.

Colour	Black	White
Gain	6dB	6dB
Length	1680mm	1680mm
Type	477MHz	477MHz
Base	CBB102	CBB102
Plug	PL259	PL259
Lead	3.6M RG58CU	3.6M RG58CU
MobileOne	CP476SBSAMPK	CP476SWSAMPK
Code	ANT829	ANT424

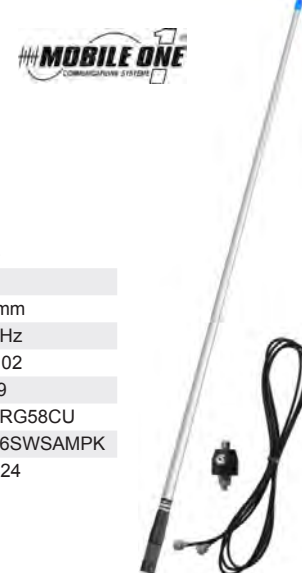



↓ CB UHF 477MHz

UHF FIBREGLASS WHIP 1200mm 6dB

MEGA-BLASTER 477MI

Wide bandwidth 25MHz to 900MHz! Multi-stacked co-linear 1.2M fibreglass, polyolefin covered. 6dB gain 450MHz to 520MHz with 1M² ground plane, but will also perform well on bull-bars, etc. Suit scanners, UHF, etc. Black. High grade construction with copper and brass. Long-life for base or mobile. Terminated 5/16" for UHF bases. Australian made. Antenna only. Mobile One M476

Gain	6dB
Length	1200mm
Colour	Black
Type	477MHz
Base	5/16"
OEM	M476
Brand	MobileOne
Code	ANT419



UHF WHIP 1500mm PHASE-4

477MHz 1.5M 6.5dB 5/16"

Deluxe construction Epoxy coated whip fibreglass black. Requires 5/16" Base FOUR phase tuning for a 6.5dBi gain.

Gain	6.5dB
Length	1500mm
Colour	Black
Type	477MHz
Base	5/16"
OEM	026264
Brand	Benelec
Code	ANT413

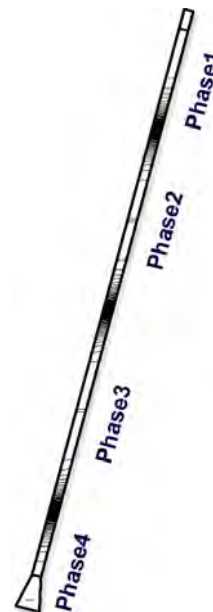

BENELEC

UHF FIBREGLASS 600mm 4.5dB

477MHz 600mm

Lightweight flexible whip high power transmitter collinear. Low SWR, low angle of radiation PVC coated fibreglass. Made In Australia. 5/16" base required. Vswr 1.5:1 over 14MHz 4.5dB Gain. Mobile One M474.

Gain	4.5dB
Length	600mm
Colour	Black
Type	477MHz
Base	5/16"
OEM	M474
Brand	MobileOne
Code	ANT821



UHF FIBREGLASS 650mm 4.5dB

ROOF MOUNT

The Benelec 02623 is 4.5dB gain, roof mount fibreglass antenna covering all UHF commercial Mobile Radio Bands. The 02623 antenna offers a genuine 4.5dB of gain on the horizon across the whole designated band of operation. All antennas are designed for optimum performance on the Benelec 02740 mobile base and cover the entire respective designated bands of operation under 1.5:1 VSWR. Its fibreglass construction with heat shrink fit coating ensures smooth strong and flexible finish.

Gain	4.5dB
Length	650mm
Colour	Black
Type	UHF 477MHz
Base	5/16"
Benelec	02623
Code	ANT534

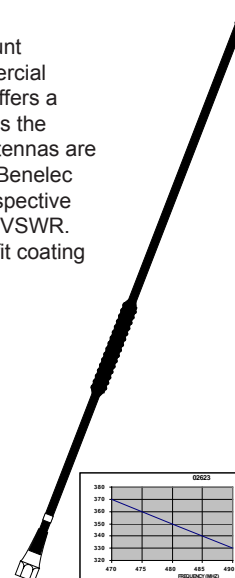

BENELEC

UHF FIBREGLASS ANTENNA

477MHz HEAVY DUTY WHIP

Fibreglass co-linear thick heavy duty with polyolefin coating. Works best when mounted onto a bracket that is as close to the surface of the ground plane as possible.

Colour	Black	White
Length	600mm	600mm
Gain	4.5dB	4.5dB
Type	UHF 477MHz	UHF 477MHz
Base	5/16"	5/16"
Mobileone	M474HDB	M474HDW
Code	ANT839BK	ANT839WH



UHFULTRA-HEAVY-DUTY 1.9M 8dB

BENELEC DESERT STICK

High gain performance in a ruggedised package. Polished Stainless Steel mounting section, and a heavy walled Fibreglas Radome. Flylead with a new generation waterproof push-pull connector for easy termination to the feed cable lead, making the antenna fully removable. The antenna radiating section is constructed in high quality semi rigid Teflon dielectric cable, ensuring reliable radiation pattern, and VSWR performance.

Gain	8dB	8dB
Length	1900mm	1900mm
Colour	Black	White
Type	UHF	UHF
	477MHz	477MHz
Base	1/2"	1/2"
Plug	"N"	"N"
Lead	10cm	10cm
Benelec	026386	026386
Code	ANT532BK	ANT532WH



BENELEC





↓ CB UHF 477MHz

UHF FIBREGLASS 1M 4.5dB

Fibreglass collinear with large heavy duty spring and 12ft coax. Available in white or black. This antenna can be mounted almost anywhere and with any type of mount and does not need to be earthed.

Gain	4.5dB	4.5dB
Length	1100mm	1100mm
Colour	Black	White
Type	UHF 477MHz	UHF 477MHz
Base	1/2"	1/2"
Plug	PL259	PL259
Mobileone	SS474B	SS474W
Code	ANT840BK	ANT840WH

Look alike to: ANT537 Cellular



UHF 477MHz 500mm 3dB

BENELEC REMOVABLE SERIES

Rugged design fibreglass enclosed. Heavy-duty spring with above detachable antenna via SO239 screw connection for removal of whip if required. Base fits 1/2" hole making these suitable for 4WD and marine.

Gain	3dB	3dB
Length	500mm	500mm
Colour	Black	White
Type	UHF 477MHz	UHF 477MHz
Base	PL259	PL259
Benelec	02634C	02634CWT
Code	ANT519BK	ANT519WH



↓ Twin Series

TWIN SERIES

MATCHING CELLULAR & UHF ANTENNAS

Dual whips of identical appearance for Left & Right mounting on Vehicles Boot lip, Bull bar, etc. Salt-water proof for Marine applications. Rugged design. Fibreglass enclosed. Stainless steel spring. Feed-through base cable design for neat installation. Short fly lead to small FME socket connector. Includes 5 Metres of low-loss cable terminated to FME with PL259 adaptor for the UHF Series. Optional Fixed or Slip-ring above spring base allows removal of antennas if required. 1/2" Stud mount for insertion into a 1/2" hole.

- Cellular All Band: GSM, NextG, GPRS, 3G. 820-960MHz & 1710-2200MHz
- UHF 476-477MHz

Length	Base	Type	Colour	Gain	Lead	Plug	Benelec	Code
890mm	Fixed Spring	Cellular	Black	3dB/6dB	5M LL195	FME Socket	024574	ANT520BK
			White	3dB/6dB	5M LL195	FME Socket	024574WH	ANT520WH
		UHF 477MHz	Black	3dB	5M RG58	FME/PL259	026383	ANT521BK
			White	3dB	5M RG58	FME/PL259	026383WT	ANT521WH
910mm	Detachable	Cellular	Black	3dB/6dB	5M LL195	FME Socket	024577	ANT522BK
			White	3dB/6dB	5M LL195	FME Socket	024577WT	ANT522WH
		UHF 477MHz	Black	3dB	5M RG58	FME/PL259	026383C	ANT523BK
			White	3dB	5M RG58	FME/PL259	026383CWT	ANT523WH
1110mm	Fixed Spring	Cellular	Black	3dB/7.5dB	5M LL195	FME Socket	024576	ANT524BK
			White	3dB/7.5dB	5M LL195	FME Socket	024576WT	ANT524WH
		UHF 477MHz	Black	6.5dB	5M RG58	FME/PL259	026385	ANT531BK
			White	6.5dB	5M RG58	FME/PL259	026385WT	ANT531WH
1130mm	Detachable	Cellular	Black	3dB/7.5dB	5M LL195	FME Socket	024578	ANT526BK
			White	3dB/7.5dB	5M LL195	FME Socket	024578WT	ANT526WH
		UHF 477MHz	Black	6.5dB	5M RG58	FME/PL259	026385C	ANT527BK
			White	6.5dB	5M RG58	FME/PL259	026385CWT	ANT527WH

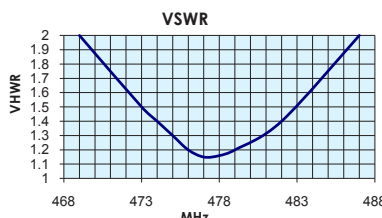
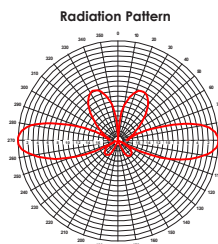



↓ Cellular

6dB 900mm BUILDING MOUNT

NextG or 3G - HEAVY DUTY BASE STATION / MARINE

Heavy duty fibreglass whip suits mobile phones and wireless internet bands, Next-G (850MHz) or 3G (2100MHz). Ground independent, includes bracket. Hardware Mounts onto the side of a building wall, etc. or 2" post mounting. Gain: 6dBm. Terminates to "N" socket. Requires connection and lead. Cellink.

Gain	6dB	9dB
Length	900mm	570mm
Colour	White	White
Type	NextG-850	3G-2100
Base	"N"	"N"
Code	ANT466	ANT468



BUILDING MOUNT
MOUNTING HARDWARE INCLUDED



"N" Connector Requires Cable

9dB GAIN CELLULAR ANTENNA

NextG 850MHz & 3G 2100MHz

Fibreglass base station Dual band tuned for NextG/3G antenna with 20mm aluminium tube mounting section for elevated feed. Includes 10M of special low-loss cellfoil coax to FME connector. Available in black or white.

Colour	Black	White
Length	1350mm	1350mm
Gain	9dB	9dB
OEM	COL823B	COL823W
Code	ANT530BK	ANT530WH



5 Year Warranty

Another Quality Product From



www.mobileone.com.au



3dB 275mm WHIP

Next-G 850 & GSM-900 CELLULAR ANTENNA FOR MAST MOUNT

Unity Gain (3dBi) covering the Next-G GSM Mobile Telephone bands 820-960MHz. Ground Independent. N-Type Socket mounting stud. Suited to mounting on marine type 1/2" mounting Brackets.

Gain	3dBi
Length	275mm
Colour	Black
Type	NextG 850 GSM900
Base	"N"
Benelec	02461A
Code	ANT609



6dB 1100MM WHIP & SPRING

NextG 850 GPRS GSM900-1800 3G-2100

850-960MHz & 2100MHz. Fibreglass antenna with stainless steel heavy duty spring, 3.6M of special low loss cellfoil coax & FME connector. Available in black or white and is suitable for all vehicles and for the marine environment.

Gain	6dB	6dB
Length	1100mm	1100mm
Colour	Black	White
Base	1/2"	1/2"
Plug	FME	FME
Lead	3.6M	3.6M
Mobileone	SS822B	SS822W
Code	ANT537BK	ANT537WH

Look alike to: ANT840 UHF



5 Year Warranty

Another Quality Product From

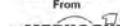

www.mobileone.com.au

7.5dB 1100MM WHIP & SPRING

NEXT-G 850, GSM900/1800 GPRS 4G LTE 3G-2100

Dual-Band Broad-band antenna. Heavy duty fibreglass whip. Suits Mobile phones and Wireless Internet bands. 820-960MHz & 1710-2200MHz. Ground independent. Bullbar & Car antenna Base station or boat. Spring base Requires 1/2" Bracket Includes Steel Spring Low-Loss Cable 5.0M to FME Female.

Gain	3dB/7.5dB	3dB/7.5dB
Length	1110mm	1110mm
Colour	Black	White
Type	Cellular	Cellular
Base	Fixed Spring	Fixed Spring
Lead	5M LL195	5M LL195
Plug	FME Socket	FME Socket
Brand	Benelec	Benelec
Code	ANT524BK	ANT524WH



7dB 740mm WHIP & SPRING

NEXT-G 850, GSM900/1800 GPRS 4G LTE 3G-2100

Dual-Band Broad-band antenna. Heavy duty fibreglass whip. Suits Mobile phones and Wireless Internet bands. Ground independent. Bullbar & Car antenna Base station or boat. 825MHz-960MHz 1710-2200MHz 70cm + Spring base Requires 1/2" Bracket Includes Steel Spring LL195 Low-Loss Cable 5.0M to FME Female.

Gain	7dB	
Length	740mm	
Type	GSM/3G/4G/LTE/NextG	
Base	Spring	
Brand	Cellink	
Colour	Black	White
Code	ANT451	ANT452





↓ Cellular

7.5dB 1M BUILDING MOUNT

NEXT-G 850, GSM900/1800 GPRS 4G LTE 3G-2100

The antenna is light weight and fitted to a stainless steel studs. The ANT529 antenna does away with the need for three separate antennas whilst maintaining high gain across the cellular bands. Comes with N socket termination. Base mount to 1/2" Hole or includes mounting kit for building. 7.5dB 825-960MHz
3.0dB 1710-2200MHz

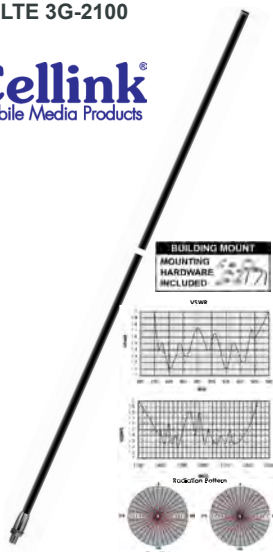

Gain	7.5dB	7.5dB
Length	1070mm	1070mm
Colour	Black	White
Type	NextG850 GSM900/1800 LTE 4G 3G-2100	
Base	"N"	"N"
Code	ANT529BK	ANT529WH

CELLINK THROUGH-GLASS ANTENNAS

4.3M CABLE TO FME-FEMALE PLUG

Double or single tuned coil (closed type) black anodized whip. Adjustable angle base long life, premium grade materials used. Improved performance and true gain models Pre-Crimped FME Female Plug. No tools required. *High gain.



Type	NEXT-G850/GSM900/ GSM1800/LTE/4G	GSM900-1800/ LTE4G/3G-2100
Gain	5dB	9dB*
Length	300mm	500mm
Base	Thru-Glass	Thru-Glass
Lead	4M x LL195	4M x LL195
Plug	FME female	FME female
Code	ANT475	ANT477

5dB THRU-GLASS WHIP ONLY

SUITS ANT475 ANT485

Replacement whip and through-glass outside base. Includes adhesive strip.



Gain	Band	Length	Code
5dB	NEXT-G850/GSM900/GSM1800/LTE/4G	400mm	WB6308
5dB	GSM900-1800/LTE4G/3G-2100	400mm	WB6310
	Extra Tape	45mm ²	ART45

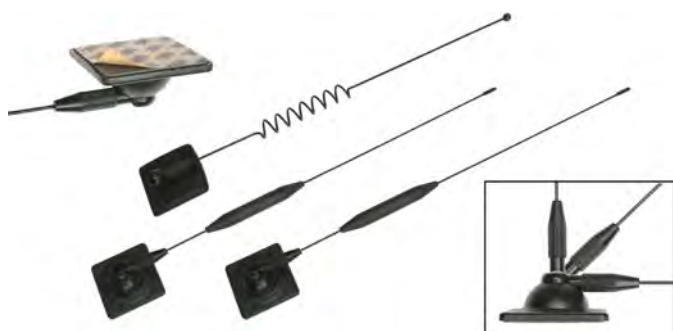

PANEL MOUNT ANTENNA 1/2"

GSM-900 & NEXT-G 850

Rubber grommet base seal. Inverted cone base 30mm. Suit permanent install. Requires drilled panel 14mm.

Gain	5dB	7dB
Length	300mm	500mm
Type	NEXT-G 850 / GSM900	
Base	Panel 1/2"	Panel 1/2"
Cable	5M x RG58A/U	4M x LL195
Plug	FME Female	
Code	ANT406	ANT447



WITH FIREWALL GROMMET

Gain	7dB
Length	500mm
Type	NEXT-G 850 / GSM900
Base	Panel 1/2"
Cable	4M x LL195
Plug	SMA Male
Code	ANT448

CELLINK MAGNETIC BASE ANTENNA

3M CABLE TO FME-FEMALE PLUG

Open spring type tuning coil. Black anodized low wind noise. High wind speed magnetic base. Rubber lined to protect duco. Excellent robust solution for non-permanent installations. Pre-crimped FME female plug. 3M of super low-loss cable.



Gain	4dB	4dB
Length	300mm	300mm
Type	NEXT-G 850	GSM 900
Base	Magnetic 28mm	Magnetic 28mm
Cable	3M RG174A/U	3M RG174A/U
Plug	FME female	FME female
Code	ANT363	ANT368



CELLINK MAGNETIC BASE ANTENNA

4M CABLE TO FME-FEMALE PLUG

Closed coil type, black anodized, low wind noise & high wind speed magnetic base for a secure hold at high speed. Rubber lined to protect duco. Compact temp install solution. Pre-Crimped FME Female Plug.

Gain	5dB	5dB	7dB
Length	520mm	520mm	520mm
Type	GSM900-1800 / LTE 4G / 3G-2100	NEXT-G 850 / GSM900-1800 / LTE 4G	
Base	Magnetic 50mm	Magnetic 50mm	Magnetic 80mm
Lead	4M x LL195	4M x LL195	4M x LL195
Plug	FME female	FME female	FME female
Code	ANT483	ANT480	ANT481





↓ Cellular

GLASS-LIP WINDOW MOUNT

3dB GSM900 & NEXT-G 850

Excellent temporary antenna solution that's quick install and effective fringe area improvement to boost reception. Simply hooks over upper-edge of an open vehicle window, then close the window to hold. 24cm Robust Rubber-Ducky type. Secure base with Thumb-screw. 3M x RG174A/U to FME Female

Gain	3dB
Length	240mm
Type	GSM900 NextG 850
Base	Window
Lead	3Mx RG174AU
Plug	FME Female
Code	ANT407



ON GLASS ANTENNA

THROUGH-GLASS CELLULAR

Benelec 02457 glass mount antenna. Suitable for ALL cellular bands NEXT-G 850, GSM900/1800, LTE 4G, 3G-2100. Designed to be mounted on the inside of the vehicles windscreen or a house window pane, etc. 195x35mm. Mobile phone unity gain dual band antenna. 820-960MHz & 1710-2200MHz. 3.0M x LL195 Coax to SMA-Male.

Band	Code
Next-G 850 / GSM900 / GSM1800 / LTE 4G / 3G2100	ANT515



ON GLASS ANTENNA

STICK-ON ADHESIVE

Semi-permanent or temporary solution. 2 Metres RG174A/U coax cable to Plug FME Female. 2.5dB 25x125mm

Band	Code
NextG 850 / GSM900 / GSM1800	ANT491
GSM900 / GSM1800 / LTE 4G / 3G2100	ANT493



DESK-TOP WIRELESS INTERNET ANTENNA

2dB NEXT-G GSM900/1800, LTE, 3G-2100

Indoor self standing or laptop clip. Includes wand and stands with angle adjust for wall mounting, etc. Stands 220mm tall. 825-960MHz, 1710-2200MHz

Band	NEXT-G 850, GSM900/1800, LTE 4G, 3G-2100
Gain	2dB
Size	220mm Tall
Lead	RG174 x2M
Plug	FME Female
Code	ANT444



ON GLASS ANTENNA

SUCTION CUPS

Semi-permanent or temporary solution. 2 Metres RG174A/U coax cable to Plug FME Female. 2.5dB 25x125mm

Band	Code
NextG 850 / GSM900 / GSM1800	ANT495
GSM900 / GSM1800 / LTE 4G / 3G2100	ANT496



EXTERNAL ANTENNAS

INDOOR PATCH BROADBAND

Flat "patch" antenna. Double sided tape affix or velcro. 1M x RG174A/U. Terminates FME female.

Gain	2.5dB	2.0dB
Length	155x55mm	75x33mm
Type	NextG/GSM/3G	NextG/GSM/3G
Lead	1M x RG174AU	1M x RG174AU
Plug	FME Female	FME Female
Code	ANT497	ANT498





↓ Cellular

CELLULAR PHONE MINI-MAST

19cm 3dB WIDEBAND

Next-G 850, GSM900/1800, LTE 4G, 3G-2100 820-960MHz & 1710-2200MHz.
Ideal fixed site solution.
Requires mounting bracket 1/2" mounting hole
17mm black ABS plastic weather resistant
3M LL195 coax SMA-male plug.

Type	NextG 850, GSM900/1800, LTE 4G, 3G-2100
Length	190mm
Colour	Black
Base	1/2"
Lead	3M x LL195
Plug	SMA Male
Benelec	02458
Code	ANT513



BENELEC

YAGI DIRECTIONAL - 3G

15dB 3G 2.1GHz

2050-2150MHz 30W 670mm strong alloy long life highly directional 15dB yagi antenna. Transmits 30W max. 50Ω 590g 670mm. Suit 3G phone network & 2.1GHz communications. Terminates to "N" female. Includes pole mount kit.

Type	3G-2100
Gain	15dB
Length	670mm
Base	Pole Mount
Plug	"N" Female
Code	ANT467

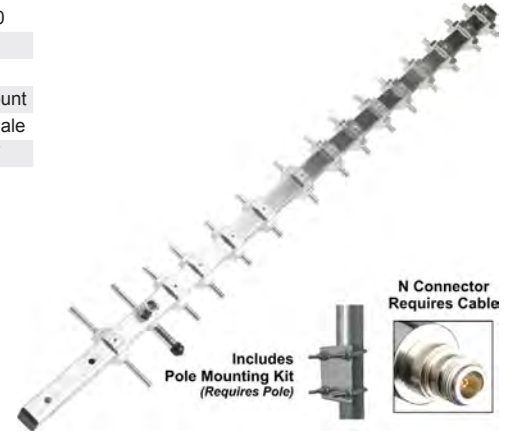

Includes Pole Mounting Kit (Requires Pole)

N Connector Requires Cable

DIRECTIONAL ANTENNA

NEXT-G 850 / GSM900-1800 / LTE 4G / 3G-2100 & WLAN

9.5dB 800-960MHz
11dB 1710-2500MHz
Size 330x215x65mm
Plug "N" female power 100W Max.
Compact, low profile. Fibreglass radome. Outdoor weather proof.
Pole mounting kit White.
Requires lead.

Type	NEXT-G 850 / GSM900-1800 / LTE 4G / 3G-2100 & WLAN
Gain	11dBi
Length	330mm
Colour	White
Base	Pole Kit
Lead	150mm
Plug	N Female
Code	ANT464

Pole Mount Kit Supplied Firing angle adjustments



Fly Lead

N Connector Requires Cable



YAGI DIRECTIONAL - GSM 900MHz

15dB GSM900 ANTENNA

890-960MHz bandwidth strong alloy long life highly directional 15dB aluminium yagi antenna. Transmits 30W max. Impedance 50W input. Suit GSM cell networks. Length 1500mm. Terminates to "N" female. Includes pole mount kit.

Type	GSM900
Gain	15dB
Length	1550mm
Base	Pole Mount
Plug	"N" Female
Code	ANT460



N Connector Requires Cable



MULTI-BAND PANEL ANTENNA

NEXT-G 850 / GSM900-1800 / LTE 4G / 3G-2100 & WLAN

Small unobtrusive profile. Wall mountable indoor use. ABS UV protected panel. Base plate is aluminium.

Power	50 Watt
Load	50 Ohm
Size	210x180x44mm
Plug	"N" Type female
7dB	824-960MHz
10dB	1710-2500MHz

Type	NEXT-G 850 / GSM900-1800 / LTE 4G / 3G-2100 & WLAN
Gain	10dBi
Length	210x180mm
Colour	White
Base	Wall Mount
Lead	150mm
Plug	N Female
Code	ANT472



"N"

YAGI DIRECTIONAL NEXT-G 2100MHz

15dB NEXT-G 850MHz

825-890MHz Next-G network yagi super directional "N" female terminal. Includes pole mount kit.

ALUMINIUM	
Type	NextG 850
Gain	15dB
Length	1550mm
Base	Pole Mount
Plug	"N" Female
Code	ANT465

STAINLESS STEEL	
Type	NextG 850
Gain	15dB
Length	1550mm
Base	Pole Mount
Plug	"N" Female
Code	ANT437



N Connector Requires Cable





↓ AVL & GPS

AVL GPS & CELLULAR SHARK FIN

TWO IN ONE HOOD MOUNT

Multi-band antenna operating in the 820-960MHz and 1710-2500MHz bands for all mobile phone coverage plus also incorporates an active GPS antenna. ABS radome is ideally suited to applications where a low profile and rugged construction is required. Exits 2x leads LL195/LL100 5M each to both same plug type. GPS requires phantom power 3-5Vdc. Made in Australia.

Plug	SMA x2	Fakra x2
Benelec	0294206	0294206F
Code	ANT528	ANT535

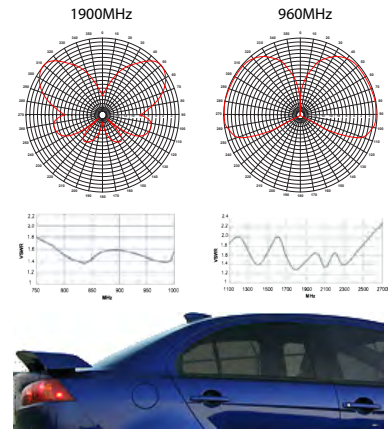

BENELEC

AVL GPS & CELLULAR CLEAR

MULTI-BAND WINDOW MOUNT

Transparent window discreet sticker type. Two full wave loops. Antenna gain is 4.5dB. Clear polyester mylar. Mount on a windscreen with "3M-467" Epoxy adhesive. Active GPS Booster for High performance 27dB. Phantom powered 3/5Vdc. Includes 3M RG174 coax. Terminates to FME plug GPS 1575.42MHz ±2MHz. Also includes cellular phone reception with a separate antenna connect GSM1800 GSM900 CDMA 4.5dB. Includes 1M RG58 coax. Terminates to FME plug. 140x75mm clear flexible. Exceptional performance. Innovative design.

Code
ANT921

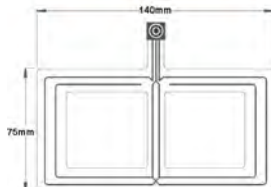
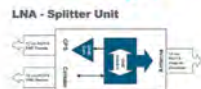

BENELEC

AVL GPS & CELLULAR SURFACE MOUNT

TRI-BAND GPS 26dB & GSM

Low profile 20x115mmØ Both GPS and Cellular In one compact unit Cellular GSM900 0dB Cellular GSM1800 0dB Satellite GPS 5dBi Active GPS Booster 27dB Weatherproof Radome White polycarbonate 16mm Hold mount Up to 6mm Thick Grommet sealed Phantom powered 3.3Vdc to 5Vdc 20mA **GPS** lead 4.5M RG174 coax Terminates to SMA plug GPS 1575.42MHz ±2MHz 27dB with 2dB Noise max. **GSM** lead 4.5M RG58 Terminates to TNC Male Compact Size 20x115mmØ Benelec 0294303

Code
ANT507



BENELEC

AVL GPS & CELLULAR ANTENNA

CONCEALED ACTIVE

Unity gain, multi band concealed antenna suited for use in all cellular bands include GSM, GPRS, Next G, WCDMA, UMTS & PCS plus a built-in high performance active GPS antenna. Includes 2.5 metres of low loss cable and SMA male connectors for each feed. Designed to be mounted on the inside of the vehicle in concealed locations, optimised to operate in free space.

Gain	3dB/5dB
Length	198x36mm
Type	AVL GPRS NextG 850 GSM900-1800 LTE 4G 3G-2100
Colour	Black
Lead	2.5Mx LL195 + LL100
Plug	2x SMA
Benelec	0294208
Code	ANT538

BENELEC



AVL GPS & CELLULAR GLASS MOUNT

TRI-BAND THROUGH-GLASS ANTENNA

GSM, GPRS, 3G, Next-G, WCDMA, UMTS & PCS. Benelec Unity gain, Multi band Glass Mount Unity gain ALL cellular phone bands. This antenna also incorporates a high performance active GPS antenna. Designed to be mounted on the inside of the vehicle front windscreen. Cellular 820-960MHz 1710-2200MHz 0dB LL195 2.5M SMA-Male GPS 1575.42MHz 5dBi Antenna 28dB amplifier 3-5Vdc Phantom LL100 2.5M SMA-Male 198x36mmØ 100g **GPS & TERRESTRIAL**

Code
ANT514

WITHOUT GPS

Terrestrial bands only

Code
ANT515



BENELEC



↓ AVL & GPS

AVL GPS ANTENNA GLASS MOUNT

DUAL-BAND 27dB

Antenna 5dBi gain active GPS booster high performance 27dB. Designed for internal mounting protection. Low profile through-glass ideal for windscreens. Quality radome cased phantom powered 3.3/5Vdc. Includes 4.5M RG174 coax. Terminates to SMA plug GPS 1575.42MHz \pm 2MHz 27dB with 2dB Noise max. Compact Size 51x41x22mm Benelec 0294101.



Code
ANT501



AVL GPS ANTENNA SURFACE MOUNT

GPS 1575MHZ 26dB

Super compact 2.5"Ø antenna 5dBi gain. Active GPS booster high performance 27dB. Designed for roof mount. Low profile and compact roof, trunk or bulkhead. Weatherproof radome white 5/8" hole mount required. Phantom powered 3.3/5Vdc Includes 4.5M RG174 coax. Terminates to SMA plug GPS 1575.42MHz \pm 2MHz 27dB with 2dB noise max. Compact Size 20x50mmØ Benelec 0294104.



50mmØ Hole
20mm High 16mmØ



Code
ANT503

AVL GPS ANTENNA MAGNETIC

MINI-EXTERNAL ACTIVE ANTENNA

1575.42MHz Bandwidth \pm 5MHz Peak Gain 3dBic (7cm² Ground plane) Coverage Gain -4dBic at \pm 90° RHCP LNA Gain 28dB Typical (Filtered) VSWR 2.0 with 3 Metres RG174 Terminated to SMA (male) Magnetic base 100% Weather proof ABS 40x35x15mm Benelec 0294105



Plug Code
SMA ANT504

AVL GPS ANTENNA BLUETOOTH

AERPRO ANTENNA

Suit portable applications. Bluetooth wireless. With Inbuilt 27dB booster, rechargeable battery and have inbuilt data modules.

Code
GPS200



AVL GPS ANTENNA ACTIVE RECEIVERS

1575MHZ MAGNETIC BASE

Suit portable applications. RF plug types. With Inbuilt 27dB booster, phantom powered by USB or 12Vdc and have inbuilt data modules.

Chipset	Plug	Code
CDX2951	USB	GPS101
SiRF	USB	GPS104

DETAILS SEE
SECTION 16
COMPUTER



AVL GPS ANTENNA CLEAR

WINDOW MOUNT 27dB

Transparent window discreet sticker. Two full wave loops. Antenna gain is 4.5dB. Clear polyester mylar. Mount on a windscreen. 3M 467 Epoxy adhesive gets stronger over time. Active GPS booster for high performance 27dB low noise output signal. Phantom powered 3/5Vdc. Includes 4.5M RG174 coax. Terminates to SMA plug GPS 1575.42MHz \pm 2MHz 140x75mm clear flexible. Exceptional performance. Innovative design.

Code
ANT920

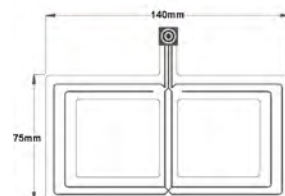



→ WiFi Antenna

WIRELESS ETHERNET WIFI

INDOOR & OUTDOOR

2.4GHz - 2.5GHz for all WiFi channels to boost coverage and strengthen data transfer speed and reliability.



WIFI INDOOR OMNI 5dB

TP-LINK WHIP 5dB

Omni-Directional 2.4-2.5GHz 5dBi SMA Reverse Plug 1M Cable length VSWR 1.92 max 1W

Band	802.11b/g
Freq.	2.4GHz
Gain	5dBi
Size	195mm
Plug	SMA-RP
Lead	1M
Brand	TP-Link
Code	ANT2405C



WIFI INDOOR OMNI 7dB

LEVEL-ONE 7dB

Attractive desktop Omni-Directional 2.4-2.5GHz 7dBi SMA Reverse Plug 1.5M Cable. 100mm 23 Vert. VSWR 2.0 Range 400M(54Mbps)

Band	802.11b/g
Freq.	2.4GHz
Gain	7dBi
Size	100mm
Plug	SMA-RP
Lead	1.5M
Brand	Level1
Code	OAN1070



WIFI INDOOR OMNI & BASE

High gain antenna with elbow joint Direct SMA-RP connection or Desktop mount kit includes base.

Band	802.11b/g
Freq.	2.4GHz
Plug	SMA-RP
Lead	1.5M
Brand	Cellink
Gain	13dBi 9dBi
Size	400mm 330mm
Code	ANT2552 ANT2551



WIFI INDOOR UNI

TP-LINK PANEL 6dB

150mm tall Directional Desk or wall mount.

Band	802.11b/g
Freq.	2.4GHz
Gain	6dBi
Size	150mm
Plug	SMA-RP
Lead	1M
Brand	TP-Link
Code	ANT2406A



WIFI INDOOR OMNI

High gain antenna upgrades with elbow joint for right angle Direct SMA-RP connection. Suit modems & cards, etc.

Band	802.11b/g
Freq.	2.4GHz
Plug	SMA-RP
Brand	Cellink
Gain	13dBi 9dBi 7dBi 5dBi
Size	400mm 330mm 280mm 200mm
Code	ANT2556 ANT2555 ANT2554 ANT2553



WIFI INDOOR DESKTOP

DUAL-BAND

Compact desktop directional for extra distance

Band	802.11b/g/n
Freq.	2.4GHz & 5GHz
Gain	6dBi & 8dBi
Size	100mm
Plug	SMA-RP
Lead	1M
Brand	Level1
Code	WAN1160





→ WiFi Antenna

WiFi UNI PANEL 18dBi

Outdoor Antenna is made of non-corrosion materials, is weatherproof with lightning surge protection. WAN-9150 & WAN-9180 are 5GHz and Dual Polarisation (Dual input).

Band	802.11b/g/n	802.11b/g/n	802.11b/g/n
Freq.	2.4GHz	5GHz	5GHz
Gain	18dBi	15dBi	18dBi
Size	360x360mm	165x140mm	256x227mm
Plug	N Female	N Female x2	N Female x2
Brand	Level1	Level1	Level1
Code	WAN2181	WAN-9150	WAN-9180



WiFi ANTENNA OUTDOOR UNI 8.5dB

LEVEL-ONE 8.5dB
Indoor / Outdoor panel Uni-Directional 70 2.4-2.7GHz 8.5dBi 120x120x43mm Beige Weather resistant. 3.0M Lead inc. "N"

Band	802.11.b/g
Freq.	2.4GHz
Gain	8.5dBi
Size	120x120x43mm
Lead	3M
Brand	Level1
Code	WAN2185



WiFi ANTENNA INDOOR PANEL

WIDE-BAND 10dBi

824-960 & 1710-2500MHz Data/Voice/Image/LAN. Indoor wall mount flat panel type. White 210x180x44mm 50W. Max power Gain is 7dBi-10dBi

Band	802.11b/g/n
Freq.	1.7-2.4GHz
Gain	10dBi
Size	210x180x44mm
Plug	N Female
Brand	Cellink
Code	ANT472



WiFi ANTENNA OUTDOOR UNI 12dB

WALL MOUNT

20W Uni-Directional UV ABS Weather resistant. 200g. With window suction cups or screws.

Band	802.11b/g/n
Freq.	2.4GHz
Gain	11dBi
Lead	3M
Plug	SMA-RP
Size	330mm
Brand	Level1
Code	WAN1112



WiFi ANTENNA CEILING OMNI

LEVEL-ONE 3dB

Above mount best indoor coverage low profile install 1.7-3.7GHz 3.7dBi SMA Reverse Plug 1M Cable. Beige. Range 40M(54Mbps)

Band	808.11a
Freq.	5.8GHz
Gain	3.7dBi
Plug	SMA-RP
Lead	1M
Brand	Level1
Code	OAN1030



WiFi BRIDGING ANTENNA 11dB

1710MHz-2500MHz OUTDOOR

Outdoor weather proof. Fibreglass radome pole mounting kit. Short fly-lead output.

Band	802.311b/g/n
Freq.	1.7-2.5GHz
Gain	11dBi
Size	330mm
Plug	N Female
Lead	150mm
Brand	Cellink
Code	ANT464



WiFi ANTENNA OUTDOOR UNI

TP-LINK PANEL 9/14dB

Directional (Yagi) 2.4-2.5GHz 9/14dBi SMA Reverse Plug 1M Cable length VSWR 1.92 max 1W

Band	802.11b/g
Freq.	2.4GHz
Plug	SMA-RP
Lead	1M
Brand	TP-Link
Gain	9dBi 14dBi
Code	ANT2409A ANT2414A



WiFi ACTIVE ACCESS POINT

11b/g 108Mbps 12dBi

IP66 Weather proof in/outdoor antenna with inbuilt IEEE 802.11g WiFi modem. Power over Ethernet (PoE) Included.

Band	802.11b/g
Freq.	2.4GHz
Gain	12dBi
Size	320mm
Plug	RJ45 PoE
Lead	25M Cat5
Brand	Level1
Code	WAP1001





WIFI OUTDOOR OMNI ANTENNA 12dB

Wall or Post mount

Band	802.11b/g/n
Freq.	2.4GHz
Gain	12dBi
Plug	N Female
Size	1200mm
Brand	TP-Link
Code	ANT2412D



WIFI BRIDGING ANTENNA

DIRECTIONAL BRIDGING 10W

Directional Yagi rod points at destination. Wall or Post mount.

Band	802.11b/g/n
Freq.	2.4GHz
Gain	18dB
Plug	N Female
Size	1000mm
Brand	Level1
Code	WAN2218



WIFI OUTDOOR OMNI ANTENNA 10dB

HEAVY-DUTY 50 WATT

Lightning Surge Protection.

Band	802.11a	802.11b/g/n
Freq.	5.8GHz	2.4GHz
Gain	10dBi	9dBi
Type	Omni	Omni
Size	750mm	525mm
Plug	N Female	N Female
Brand	Level1	Level1
Code	OAN4101	OAN2090



WIFI OUTDOOR OMNI ANTENNA 15dB

HEAVY-DUTY 50 WATT

Heavy Duty Omni Rod 2.4-2.5GHz ISM Band radome
Fibreglass "N" Female terminal Lead SMA Reverse
3M Clamps U-Bolt base 1860mm x 51mm

Band	802.11b/g/n
Freq.	2.4GHz
Gain	15dBi
Plug	N Female
Size	1860mm
Brand	Level1
Code	OAN2151



WIFI PARABOLIC GRID ANTENNA

DIRECTIONAL BRIDGING

High-gain long-distance outdoor weather-proof directional connection.

Band	802.11b/g/n
Freq.	2.4GHz
Gain	24dBi
Type	Uni
Size	60x100cm
Plug	N Female
Brand	TP-Link
Code	ANT2424B

