

**PRODUCTS NOT LISTED IN THE 2012 CATALOGUE**

THE FOLLOWING PRODUCTS MISSED BEING INCLUDED IN THE 2012 CATALOGUE. PLEASE KEEP THIS SUPPLEMENT WITH YOUR EDITION FOR FUTURE REFERENCE.



# 2012

## GLOBAL PROCUREMENT CATALOGUE

SUPPLEMENT - NEW PRODUCTS

**WATERPROOF 'F' CONNECTER COMPRESSION TOOL**

**WATERPROOF CONICAL 'F' COMPRESSION**

Heavy duty construction and is designed to apply the correct amount of pressure so as to obtain a perfect result. Waterproof connection. Maintains originality of coax cable. Professional finished appearance.

Code  
HT507



Only suitable for the conical 'F' connectors (F507).

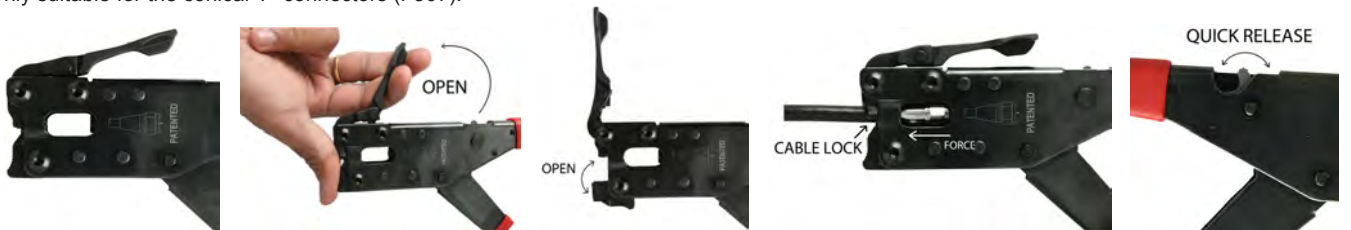

**RG6 QUAD CONICAL 'F' CONNECTER WATERPROOF CONNECTION**

The design of the collar ensures that uniform pressure is applied to the cable which results in waterproof connection, Reduce return losses (Keeps coax cable in original shape), professional finished appearance.

Type Code  
RG6QUAD F507



**ALKALINE BATTERIES**

**GREAT FOR INSTANT POWER**

Camelion Plus Alkaline batteries are built to readily start up high drain devices with dynamic instantaneous power. Delivers a stable current for many hours. Has long lasting power and shelf life. Ideal for most high power operated devices such as CD players, toys, PDAs, electric games, radios, flashlights and remote controls.

Size	Capacity	Code
'AAA'	1250mAh	CA-LR03-BP4
'AA'	2800mAh	CA-LR6-BP4
'C'	8450mAh	CA-LR14-BP2
'D'	2100mAh	CA-LR20-BP2
'9V'	700mAh	CA-6LR61

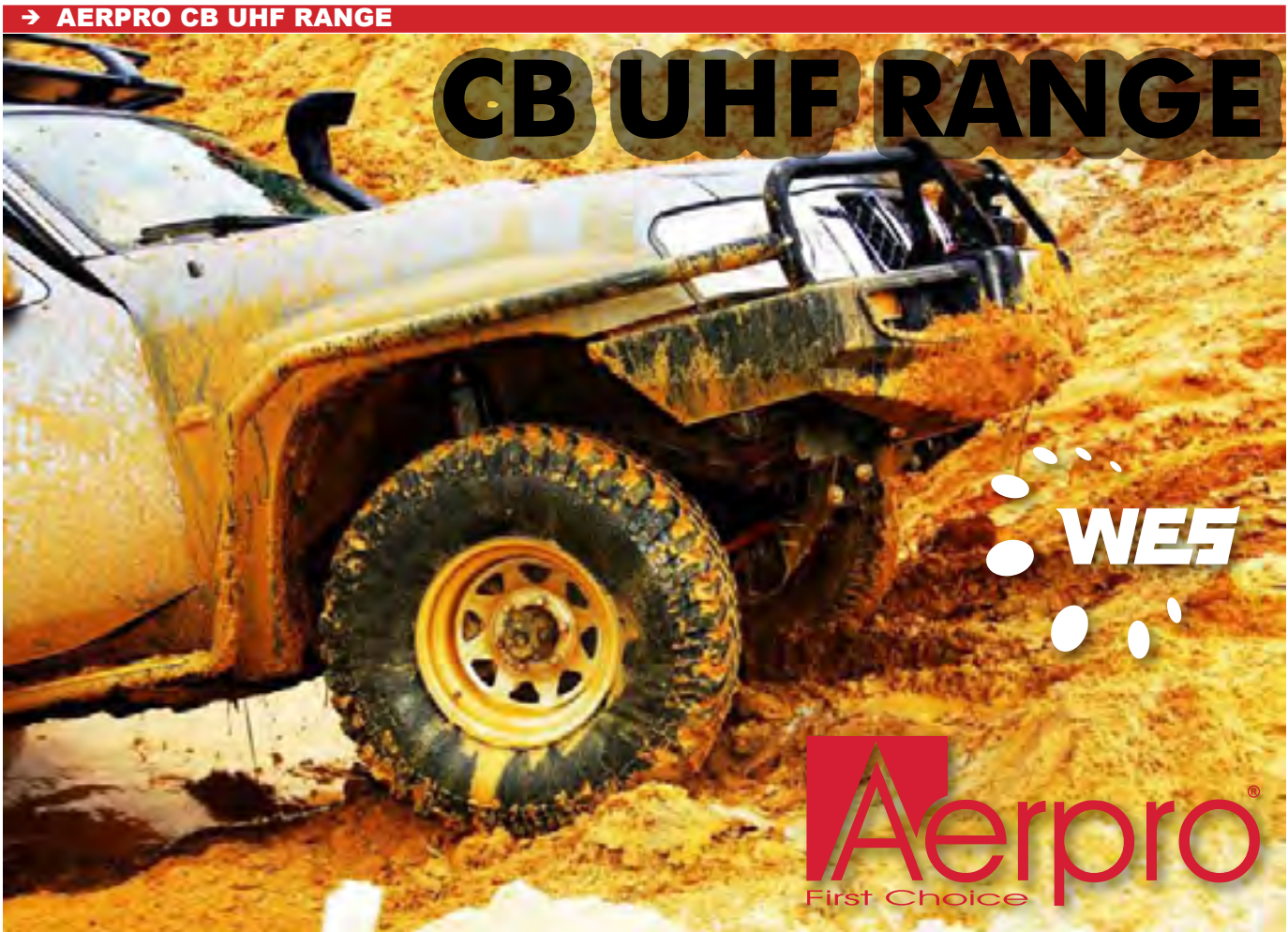

→ AERPRO CB UHF RANGE

**CB UHF RANGE****DUAL UHF KIT**

Elevated feed base with two antennas.  
 3dbi 477MHz 15cm Flexible Antenna.  
 6dbi 477MHz 65cm High-Gain whip.

Code  
 CBA36F1L

**6DB UHF 65CM**

Elevated feed  
 Heavy Duty Spring  
 6dbi 455MHz  
 65cm Whip

Code  
 CBA3F1L





#### 4.5DB UHF 75CM

Elevated feed 75cm 4.5dbi  
Enclosed ABS tube whip  
Heavy Duty Spring Base

Code  
CBA2T1



#### 4.5DB UHF SPRING WHIP

5.4dbi 455MHz Coil Loaded Stainless Steel Whip  
No base supplied. Requires CBBL1/2

Code  
CBA4S1

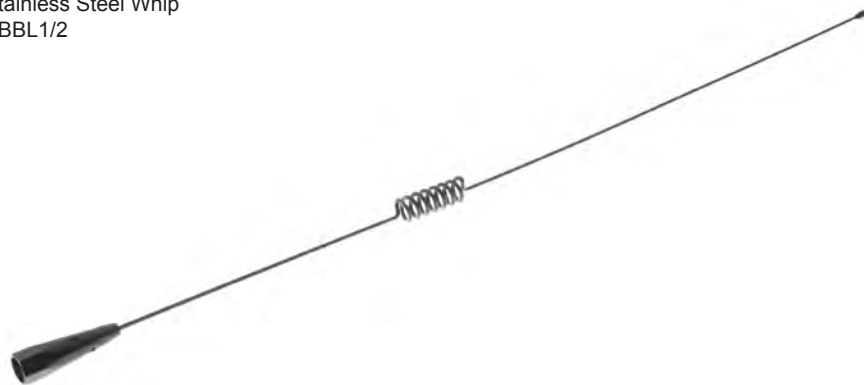

#### 6DB UHF 90CM

6dbi 477MHz Fibreglass Whip Multiple Loading

Code  
CBA5F1



#### 27MHZ WHIP

Fibreglass Whip Antenna 27MHz

Code  
CBA3FX





### CB GUTTER MOUNT

Code  
CBA36



### L BRACKET

Silver Wall Bracket  
250mm Stand-Off  
1/2" Antenna Mount

Code  
CBAWB1



### L BRACKET

Black wall bracket  
150mm stand-off  
Suils 1/2" base

Code  
CBAWB2



### BULLBAR MOUNT ALLOY

Extruded alloy type. Horizontal or Vertical mount bar bracket. Includes nuts and bolts.

Code  
CBBB3



### BULLBAR MOUNT STRAP

CB Antenna bracket  
hose clamp type

Code  
CBBB2



### BULLBAR MOUNT U-BOLT

Horizontal mount bracket with U-Bolts.

Code  
CBBB4



### BULLBAR MOUNT STEEL

Stainless Steel type.  
Horizontal or Vertical  
mount bar bracket.  
Includes nuts and bolts.

Code  
CBBB1



## UHF BRACKET

Guard mount CB Antenna bracket. Angled universal Stainless Steel.

Code  
CBBU1



## UHF BRACKET

Guard mount CB Antenna bracket. Angled universal Stainless Steel.

Code  
CBBU2



## UHF BRACKET

Guard mount CB Antenna bracket. Double bend, angled universal Stainless Steel.

Code  
CBBV1



## UHF BRACKET

Guard mount CB Antenna bracket. Vertical angled universal Stainless Steel.

Code  
CBBV2



## CB MIC CLIP

Screw on type CB microphone clip.

Code  
CBMC



## CB LEAD

477MHz UHF Base and RG58 lead 5M to PL259 Plug.

Code  
CBBL1



## CB LEAD

477MHz UHF Base and RG58 lead 5M. Separate FME to PL259 Plug.

Code  
CBBL2



## CB SPEAKER

15Wmax 8 Ohm Extension Speaker. 1.8M lead to bare ends. Angle adjustable mounting bracket. Compact 100x82x59mm

Code  
CBXS





# KM RANGE MASTHEAD AMPLIFIERS

www.kingray.net.au

## Introducing the NEW KM range of masthead amplifiers.

Kingray are proud to introduce the latest Australian designed amplifier range. The use of Advanced Surface Mount Technology and mechanical design offers renowned Kingray quality and value in a compact housing.

**Note:** The KMD24FS input filtering rejects band 1, to optimise digital reception.

### Features

- > Amplifies both analogue and digital signals
- > Combined or separate antenna inputs
- > Adjustable gain controls
- > Shielded case
- > F type connections
- > Weather resistant housing
- > Packed with a power supply & injector
- > 3 year warranty
- > Includes adjustment tool

**Trade Packs Available  
Buy In Bulk and Save!  
(TP in 5 pieces box)**



**NEW**

Combined or separate antenna inputs.

Gain controls

Output connector

Combined or separate antenna switch.

Weather resistant outdoor housing.



**Kingray**

	KMW32FS-DP/TP	KMD24FS-DP/TP	KMU32FS-DP/TP
Frequency range	VHF 44 - 230 MHz UHF 520 - 820 MHz	VHF 174 - 230 MHz UHF 520 - 820 MHz	VHF 44 - 230 MHz UHF 520 - 820 MHz
Max. gain	VHF 26 dB UHF 32 dB	VHF 15 dB UHF 24 dB	VHF -2 dB UHF 32 dB
Gain control	VHF 10 dB UHF 10 dB	VHF 10 dB UHF 10 dB	VHF n/a UHF 10 dB
Noise figure	VHF < 3 dB UHF < 2.5 dB	VHF < 3 dB UHF < 2.5 dB	VHF < 3 dB UHF < 2.5 dB
Max. output	108 dB @ -60 dB IMR (DIN45004B)	108 dB @ -60 dB IMR (DIN45004B)	108 dB @ -60 dB IMR (DIN45004B)

# Rapstrap

## Releasable Tie Strip

### Taking the world by storm

The new break through innovation in releasable tie strips.

Rapstrap is made using a soft and elasticated polyurethane. It is a long chain of cells that can slide through each other forming loops at any point, which can then be pulled tight. The remaining portion can be cut off and used again and again. As a result a single Rapstrap can perform several ties, and just gets a little shorter with each use which can reduce waste & save money. Available in 300mm Black, Transparent and Green.

The Rapstrap design is not only unique in its format but also its functionality:

**RE-USABLE** - Tie and untie it again and again

**SOFT AND FLEXIBLE** with up to 60% stretch

**MORE EFFICIENT**, as you get 3 to 5 ties from each 300mm length

**SECURE** - Tested to hold up to 12kgs

**How does it work?** RapStrap is a new way to quickly tie up just about anything.....



Each strip has 6 rapstraps. To remove a strap from the strip, pull apart by holding the tongues firmly.

Always thread the tongue through the cells toward the end of the rapstrap. This maximises the loop size and minimises waste.

Cut and repeat for more ties. The unused rapstrap portion can be removed and used again. Straps typically provide 3-5 ties.

Re-thread to remove and re-use. Remove rapstraps by re-inserting the tongue back through the same cell in the opposite direction, then pull back through to release.

### RELEASABLE TIE STRIPS

Colour	Length	Code
Black	300mm	RTS24BK
Clear	300mm	RTS24TP
Green	300mm	RTS24GN
Black	300mm	RTS48BK
Clear	300mm	RTS48TP
Green	300mm	RTS48GN
Black	300mm	RTS96BK
Clear	300mm	RTS96TP
Green	300mm	RTS96GN

### ALSO IDEAL for CAT5 and CAT6 data cables.

Standard cable ties can be pulled too tight and cause pressure points, resulting in adverse electrical performance. The RapStrap, even when pulled tight is soft and elastic resulting in minimal even pressure on the cable, therefore eliminating pressure points. In addition, if another cable needs to be added to the bundle, the RapStrap is re-useable.

The RapStrap is flame retardant and UV stabilised which makes them ideal for outdoor use.





## SINGLE JOINT INCLINABLE WALL BRACKET

Inclinable wall bracket with one articulation

max	Suits	VESA	Arm	Colour	Code
10Kg	10 - 22"	50x75x100	80mm	Black	OMB06098

OMB  
PRODUCTS  
Section 20

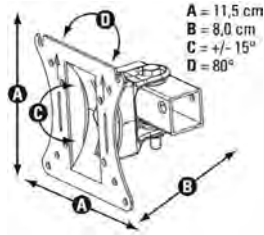

## TUTOR MOBILE MOUNTING BRACKET

### INTERACTIVE BOARDS AND PROJECTORS SUPPORT

Universal metal tongues Locking device. 400mm gas springs height adjustment. Universal projector mounting that consents the bundling of the wires between the video projector and the computer. 360 degree rotation of the support and the bracket with locking device to facilitate transport. Structure weight 30kg. Just add a screen (not included).

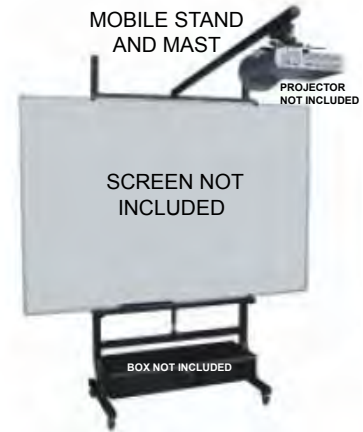

max	Suits	Height	Colour	Code
25Kg	Universal	208-248mm	Black	OMB36155

## TUTOR WALL MOUNTING BRACKET

### INTERACTIVE BOARDS AND PROJECTORS SUPPORT

Universal metal tongues Locking device. Height adjustment spring check pins located in 6 set positions every 10cm for a maximum drop of 500mm. Universal projector mounting that consents the bundling of the wires between the video projector and the computer. 360 degree rotation of the support. Structure weight 17kg.

max	Suits	Height	Colour	Code
25Kg	Universal	1800mm	Black	OMB36153

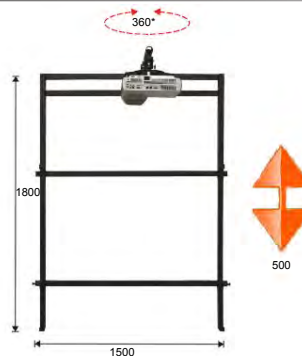

## UNIVERSAL WALL PROJECTOR MOUNT

### VIDEO PROJECTOR SOLUTION

A wall mount suitable for video projectors short view. The distance to the wall can be adjusted manually and its distinctive mechanism permits even the slightest tilt. Easy installation.

max	Suits	Arm	Colour	Code
15Kg	Universal	900-1265	White	OMB16159



omb®

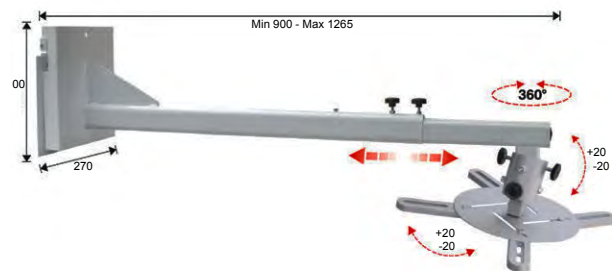

## PRECISION PROJECTOR BRACKET

### HIGH PRECISION ADJUSTMENTS

The intuitive micro-metric adjustment system provides 4 practical knobs to lock the projector in the desired position. Lateral distance can be regulated.

max	Arm	Colour	Suit	Code
15Kg	510-850mm	Silver	Universal Projector Mount	OMB26150
15kg	510-850mm	Black	Universal	OMB36150

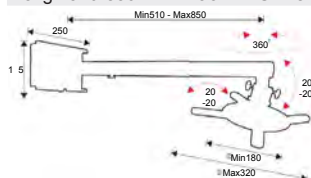



**2 CHANNEL LINE MIXER**

**BROADCAST & RECORDING MIXER**

The Mini-Mix Line Mixer allows the mixing of a 1/4" line signal source and a stereo line (RCA) source. Line level output allows an amplifier to be driven directly. Individual volume control for both channels. Ideal audio / video applications and aerobics instructors. Power supply included.

**Features**

- Input Ch. 1 - 1/4" jack
- Unbalanced line input, eg microphone, wireless microphone, instrument level signal, etc.
- Input Ch.2 - 2 RCA Sockets
- Line level signals, eg CD player, MP3 player, DVD etc.

**Specification**

- CH1 Max. Gain:-32dB.
- CH2 Max. Gain:-20dB.
- CH1 Input Impedance:-10KΩ.
- CH2 Input Impedance:- 20KΩ.
- Output Impedance:- 50Ω.
- Power :-12V DC/150mA adapter.
- Dimension:-95x 73x 40 mm.
- Weight:-229g.

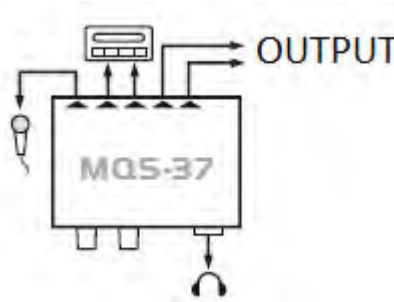

Channel Code  
2 CH MQS37

**4 CHANNEL PASSIVE MIXER**

Designed for expanding a console mixer, mixing microphones, instruments, stereo to mono, etc. Each channel has a volume control.

**Features**

- Input: 4x 1/4" unbalanced jacks for connection to line or instrument level devices.
- Output: 1x 1/4" unbalanced jack for connection to a mixer input or other input device.
- This unit may be used a 1-in-4 out box when all controls are turned completely clockwise.
- Power: No power required

**Specification**

- Input Impedance- 47KΩ.
- Output Impedance- 12KΩ.
- Gain- -13dB.
- Dimension- 95x 73x 40 mm.
- Weight- 321g

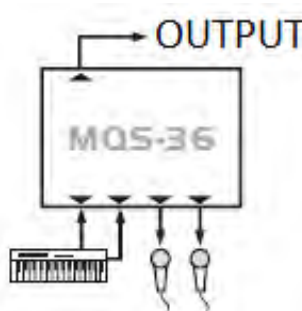

Channel Code  
4 CH MQS36

SUPPLEMENT - NEW PRODUCTS

**IP44 WIRELESS DOOR CHIME KIT****UP TO 75M OPERATING RANGE**

Portable Chime with 8 selectable sound options. Belt clip or wall mounted options. LED light signal sender. In built low battery indicator. Requires 1x3V CR2032 (included) and 2x'AA' batteries (not included). Size-110x70x35mm.

**Features**

No wiring needed.  
75M operating range.  
Surface mounted.  
8 Selectable sound options.  
Volume control option.  
IP44 rated bell push - use outdoors undercover.

Colour Code  
White SX81

**ADDITIONAL BELL PUSH**

An additional bell-push for multiple door entry system.

Code  
SX30



OPERATING RANGE

**IP44 WIRELESS DOOR CHIME****UP TO 100M OPERATING RANGE**

Extra loud wireless door chime with 8 selectable sound options. Portable, no installation required. Flashing light option for noisy environments. Requires 1x3V CR2032 (included) and 3x'C' batteries (not included). Size- Ø75x140mm.

**Features**

Flashing Light.  
No wiring needed.  
Can connect to up to 6 bell pushes.  
8 selectable sound options.  
Extra loud sounds.  
Volume control option.  
IP44 Rated bell push - use outdoors under cover.

Colour Code  
White BY301

**ADDITIONAL BELL PUSH**

An additional bell push for multiple door entry system.

Code  
BY30



OPERATING RANGE



FLASHING LIGHT



FLASHING LIGHT



**WIRED WALL MOUNT DOOR CHIME KIT**

**WIRED**

Wall mount door chime kit with ringing bell sound. Battery operated or mains connection with optional transformer. Kit includes door chime, bell push, 8M bell wire and clips. Requires 2x'D' size batteries (not included). Size- 160x85x50mm.

**Features**

Mechanical bell sound.  
Battery or mains operated with optional transformer.  
Kit includes all components for installation.

Colour Code  
White BY1217



**Byron**<sup>TM</sup>

SUPPLEMENT - NEW PRODUCTS

**WIRED WALL MOUNT DOOR CHIME KIT**

**WIRED**

Wall mount traditional door chime kit with "Ding Dong" sound. Battery operated or mains connection with optional transformer. Kit includes door chime, bell push, 5M bell wire and clips. Requires 1x9V battery (not included). Size- 115x115x40mm.

**Features**

Single 'Ding Dong' sound.  
Battery or mains operated with optional transformer.  
Kit includes all components for installation.

Colour Code  
White BY720



**Byron**<sup>TM</sup>



**DIAGONAL CUTTING NIPPER****HEAVY DUTY CUTTING TOOL**

Diagonal Nippers are a high quality heavy duty cutting tool capable of cutting both steel wire 2mm in diameter and copper wire 3.2mm in diameter. Made in Japan from S58C Steel. 150mm long.

Code  
NK-36

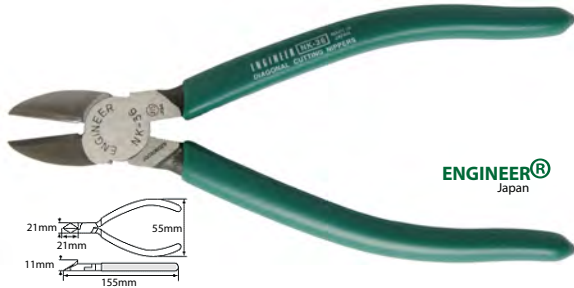
**SLANT EDGE CUTTING NIPPER****WITH Ø1.2 & Ø1.6mm STRIPPING HOLES**

Slant edge cutting Nippers are a high quality heavy duty cutting tool capable of cutting steel wire Ø1.4mm, copper wire Ø2.6mm and Ø2mm of stranded. Made in Japan from S58C Steel. 159mm long.

Code  
NN-46

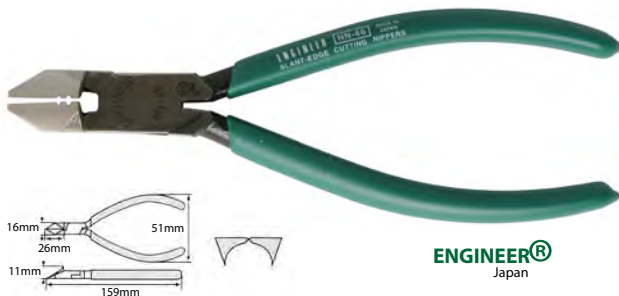
**SLANT EDGE CUTTING NIPPER****PROFESSIONAL GRADE**

Slant edge cutting Nippers are a high quality heavy duty cutting tool capable of cutting steel wire Ø1.4mm, copper wire Ø2.6mm and Ø2mm of stranded. Made in Japan from S58C Steel. 159mm long.

Code  
NN-56

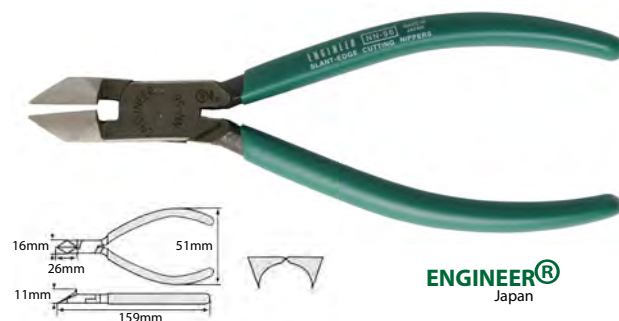
**DIGITAL DC VOLTAGE PANEL METER****18mm LED RED FOUR DIGIT DISPLAY**

Mini 4 digit LED display panel meter.  
Small size with quick mounting.  
3 readings per second sampling rate.  
5V DC operating voltage.  
Size: 79 x 42.5 x 25mm.

Range	Code
0-50V DC	DPM100
0-100V DC	DPM101

**DIGITAL DC AMP PANEL METER****18mm LED RED FOUR DIGIT DISPLAY**

Mini 4 digit LCD display panel meter.  
Small size with quick mounting.  
3 readings per second sampling rate.  
5V DC operating voltage.  
Size: 79 x 42.5 x 25mm.

Range	Code
0-5A	DPM200
0-10A	DPM201

**6.35mm MONO IN-LINE SOCKET****HIGH QUALITY PLASTIC MATERIAL**

Type	Code
Mono	S210ME





**WIRELESS REMOTE CONTROL POWER SOCKET**

**RF REMOTE CONTROL SOCKET**

Turns appliances on / off with a wireless remote control transmitter. 20 metres operating range. Includes 3 receiver sockets to control power to items such as lamps and small appliances.

**Specifications**

- Voltage- 240VAC~ / 50Hz
- Rating- 10A / 2400W max.
- Code Setting- Learning
- Learning code- More than 1 million combinations
- Remote Frequency- 433.92MHz
- Remote Range- 20 Metres

Code  
PT9723



SUPPLEMENT - NEW PRODUCTS

**AUTOMATIC ANTENNA ROTATOR**

**IR REMOTE CONTROL**

Get pinpoint positioning of your outdoor antenna with the AR REMOTE heavy-duty rotator. The motorised unit features an all-weather construction and is controlled by a 12 channel programmable memory.

**Features**

**IR Remote:**

- 16 function soft-touch key pad remote.
- Manual positioning key provides fine tuning for locations not stored in memory.

**Programmable Memory:**

- Pre-set to 12 TV/FM station directions for automatic antenna positioning.
- Non-volatile memory holds locations during power failures.
- Learning key shown the time of one rotating cycle.

**Digital Display Controller:**

- Microprocessor controlled with 18 functions.
- Digital display indicates antenna position during operation.
- Left and right keys for manual control of rotation.
- 2 digital displays for Channel station indication & Direction indication.

**Specifications**

- Motor: 18VAC
- Input voltage: 240V AC, 50Hz.
- Rotation Time: 80 seconds (50Hz)
- Vertical Load: 36Kg MAX
- Rotation: 360° ± 10° with mechanical stop
- Rotation Torque: 182 kg-cm MIN
- Accommodates masts from 28 ~ 44.5 mm (1 1/3" to 1 3/4")
- Cable: 3 wire
- Gross weight: 3.9kg

Code  
AR-REMOTE



## SAMSUNG REPLACEMENT REFRIGERATOR FILTER

### NSF CERTIFIED SAMSUNG AQUA PURE PLUS

The NSF Certified replacement filter suits Samsung refrigerators with an internal, short, round, vertically placed filter. Reduces bad taste, Chlorine, dirt, rust, odors and other particles. The filter is approximately 7.5cm in diameter and 15cm high. Filter also known as HAFIN2 EXP. It replaces the following filters. DA29 00003, DA29 00003G, DA29 0003B, DA29 00003A, DA61 00159, DA61 00159A, HAFCU EXP, HAFIN2 EXP, WF289. Suits to many Samsung models.

#### Specification

Flow Rate- 1.9 lpm.  
Operating Temperature- 0.6°C-38°C.  
Pressure- 138 kPa - 862kPa.  
Function- Chemical / Mechanical.  
Capacity- 1136 Ltr

Code

DA29-00003G



## REPLACEMENT REFRIGERATOR FILTER

### NSF CERTIFIED MICRO FILTER

Enjoy fresh and pure water. NSF certified micro filter Reduces bad taste, Chlorine, dirt, rust, odors and other particles. Replaces filter model No WSF-100. NSF Code No - K3MFC2010F Fridge Model No - HAFEX/EXP. Fits to all major brands like Electrolux, Whirlpool, Gibson, LG, Samsung, Frigidaire, Kelvinator, Tappan, General Electric & White-Westinghouse with 1/4" vinyl to copper water supply line.

Flow Rate- 1.9 lpm.  
Pressure- 207 - 689 kPa.  
Temperature- 1-38°C  
Capacity- 3785 Ltr

Code

DA29-10105J



## YPbPR / VGA TO HDMI CONVERTER

### Full HD 1080P With HD Audio

A Single source converter either VGA or YPbPr to HDMI output. Easy input selection by selector switch. The converter allows RGB signal to be converted easily to TMDS(Transition-minimized differential signal). Left/right RCA and 3.5mm mini jack for audio input (only one source will be active at a time).

#### Features

One YPbPr input  
One VGA input.  
R/L analog audio input.  
3.5mm Stereo Mini-Jack audio input.  
One HDMI signal output.  
One RCA & SPDIF for HD audio output.  
Support input up to 1080P via component.  
Support VGA input- VGA@60, VGA@75, XGA@60Hz, XGA@75, SXGA@60Hz, SXGA@75Hz, SVGA@60, SVGA@75, 1280X768@60  
HDMI output resolution:720P/ 60Hz.  
Adaptive PAL / NTSC standard.  
LED indication : when source is working,  
Inputs can be switched with the IR remote control or manual button.

#### Specification

Input Signal Support- CVBS and AV  
Support VGA output- 800×600@60HZ;1024×768@60HZ;  
1280×1024@60HZ  
Support resolution- up to 1250lines  
Max refresh rate- 75HZ  
Input Video signal- 0.5~2.0Volts p-p  
Output video signal - 0.35~0.7Volts p-p  
Input/Output TMDS signal- 0.5~1.5Volts p-p  
Power Supply- 5V DC@2A  
Dimension- 178x65x27 (mm)

Code

HDMI201





**HOBBYIST SOLDERING STATION**

**48W VARIABLE TEMPERATURE CONTROLLED**

A high quality compact design soldering station. Adjustable temperature controller, controls a very wide range of temperature (100°C - 450°C). Comes with 1.5mm tip. Many more replacement tips available.

**Features**

- Compact base station with cleaner sponge
- Safety guard iron holder built-in stand
- Rotary temperature control setting
- Variety of replacement tips available
- Adjustable temperature soldering station
- On/off switch with power on indicator light
- Integral tip cleaner, with included cleaning sponge
- Variable temperature control range from 100C to 450C.

Code  
ZD99



**ZD99 REPLACEMENT TIPS**

Size	Code
1.5mm	ZDTIP1
0.5mm	ZDTIP2
3.0mm	ZDTIP3
2.0mm	ZDTIP4

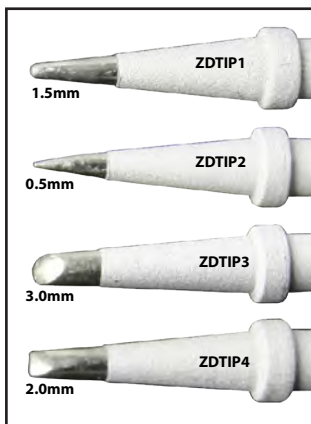

SUPPLEMENT - NEW PRODUCTS

**AERPRO CATALOGUE**

**INSTALLER EDITION 2012**

**VEHICLE SPECIFIC PARTS**

- \* Replacement Car Radio Antennas
- \* Car Radio Wiring Harness Solutions
- \* In-Dash Car Radio Mounting Kits

**CAR AUDIO ACCESSORIES**

- \* Car Amplifier Wiring Kit Solutions
- \* Power and Speaker Cable Kits & Reels
- \* Car Audio Connections & Interconnects
- \* 12V Power Distribution & Adaptors
- \* Mobile Media & Phone Mounting Brackets
- \* Car Speakers and High Power Subwoofers
- \* Subwoofer Enclosures Automotive use
- \* Custom Installer Modification Parts
- \* Audio Installer Tools and Hardware
- \* Automotive Lighting Effects

**NAVI-GATOR PRODUCT RANGE**

- \* Reversing Cameras & Monitors
- \* Wireless or Connected solutions
- \* Front Dash LCD Monitors & Mounts
- \* IP67 Number Plate Mount Cameras
- \* Integrated Reverse & GPS Kits
- \* Car Parking Sensor Systems

**BLUETOOTH**

- \* Zero-Install Bluetooth Wireless
- \* Hands-Free Mobile Phone Solutions

Code  
AERCAT FREE

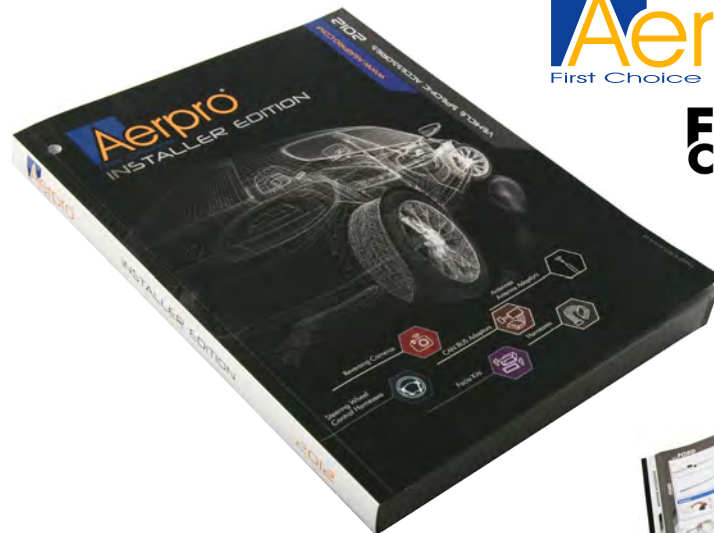

<http://www.aerpro.com.au>

## POWER LINE NETWORK TRANCEIVER PAIR

### 200Mbps WITH AC PASS THROUGH

The NetComm 200Mbps Power line Adapters with AC Pass-through allow you to create an Internet connection point anywhere in your house using the existing network of power lines. The Internet signal is transferred between the two pre-paired adapters – all you have to do is connect them to an available power point. With more devices becoming Internet enabled, there is a need for connections in various rooms of the house. It provides an easy way to transfer the Internet from your modem and supplies fast and reliable Internet access to your chosen device. With built in AC pass-through, you are able to use the same power point to plug in other electrical appliances. This allows you to connect the power line adapter directly to the wall, guaranteeing the best possible signal and reduces the likelihood of needing to use power boards and double adapters. Built-in filtering to reduce noise introduced by other electrical devices around the home to improve the network performance over the power lines. A very compact form factor and is unobtrusive and easy to conceal behind furniture and home entertainment units.



### FEATURES

Plug and play - no setup required

High speed data rates of up to 200Mbps

Transfer the Internet around your house using the existing network of power lines

Ideal for connecting PCs, TVs, gaming consoles, blu-ray players, TiVo and other network devices

AC pass-through built in - plug other electrical devices into the same power point

AC pass-through socket uses noise filtering to ensure your data signal is not disrupted by other electrical devices

Extremely compact in size - fits nicely behind furniture or amongst a home entertainment environment

Code  
NP204

Compatible with more NP204 and also NP206

### Multiple Room Connections

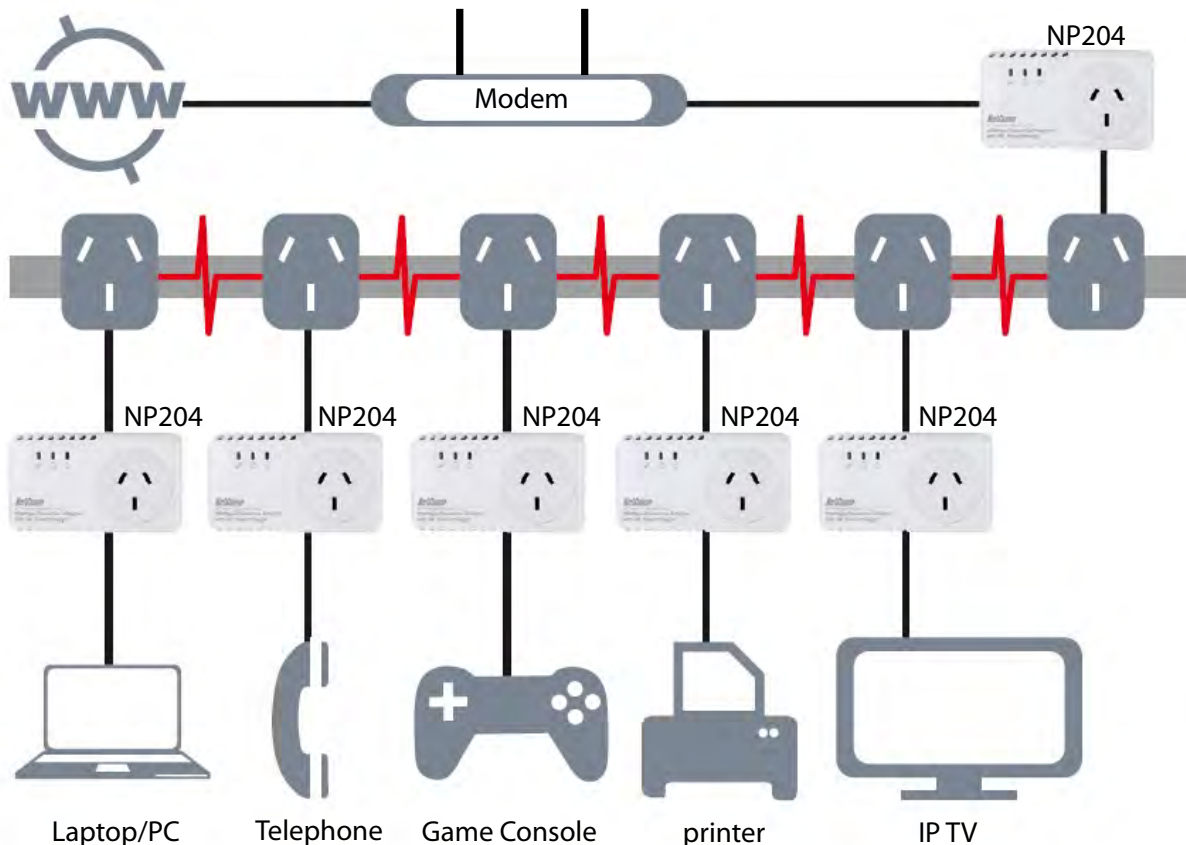



**POWER LINE NETWORK SEND/RECEIVE PAIR WITH WIFI HOTSPOT**

**RJ45 TRANSMITTER AND RJ45 RECEIVER WITH WIRELESS**

Wireless Power line Kit allows you to extend the Internet network in your house using the existing power lines in your walls. The Internet signal is transferred between the two pre-paired adapters – all you have to do is connect them to an available power point. It provides an easy way to transfer the Internet from your modem and supplies fast and reliable Internet access to your chosen devices. The kit includes one Power line adapter that has an AC pass-through socket, allowing you to conveniently use the same power point for other electrical devices. This adapter features built in filtering ensuring other electrical devices do not affect the performance of the power line network. The second Power line Adapter has built-in wireless N functionality, enabling you to extend the wireless network at home. Simply plug the adapter into any wall socket to create an instant wireless hot spot. Both adapters are very compact allowing for neat and unobtrusive placement within the home. Enhanced Quality of Service (QoS) provides guaranteed bandwidth reservations for specific multimedia IP streams.



**FEATURES**

- Plug and play - no setup required
- High speed data rates of up to 200Mbps
- Wireless data rates of up to 300Mbps
- Transfer the Internet around your house using the existing network of power lines
- Wireless N access point built into one adapter - extend or create a wireless network
- Ideal for connecting PCs, TVs, gaming consoles, blu-ray players, TiVo and other network able devices
- AC pass-through built into the other adapter - plug other electrical devices into the same power point
- AC pass-through socket uses noise filtering to ensure your data signal is not disrupted by other electrical devices
- Extremely compact in size - fits nicely behind furniture or amongst a home entertainment environment

Code  
NP206

Compatible with NP204

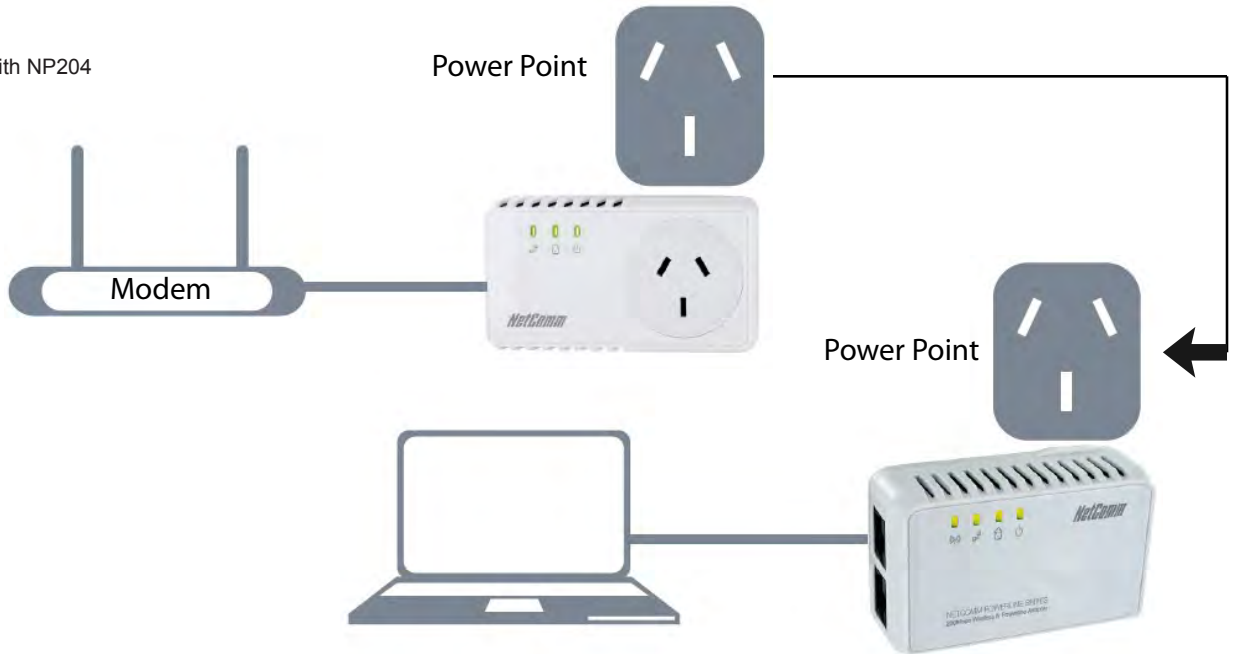

**Establishing Wireless Connection**



SUPPLEMENT - NEW PRODUCTS



Model #AKCLP1 &amp; 2

**KOOKABURRA™***Designed & tested for digital reception in Australia*

ANTENNAS



RoHS

**DIGITAL**  
Ready

- ✓ URBAN
- ✓ SUBURBAN
- ✓ RURAL

Code  
AKCLP1  
AKCLP2

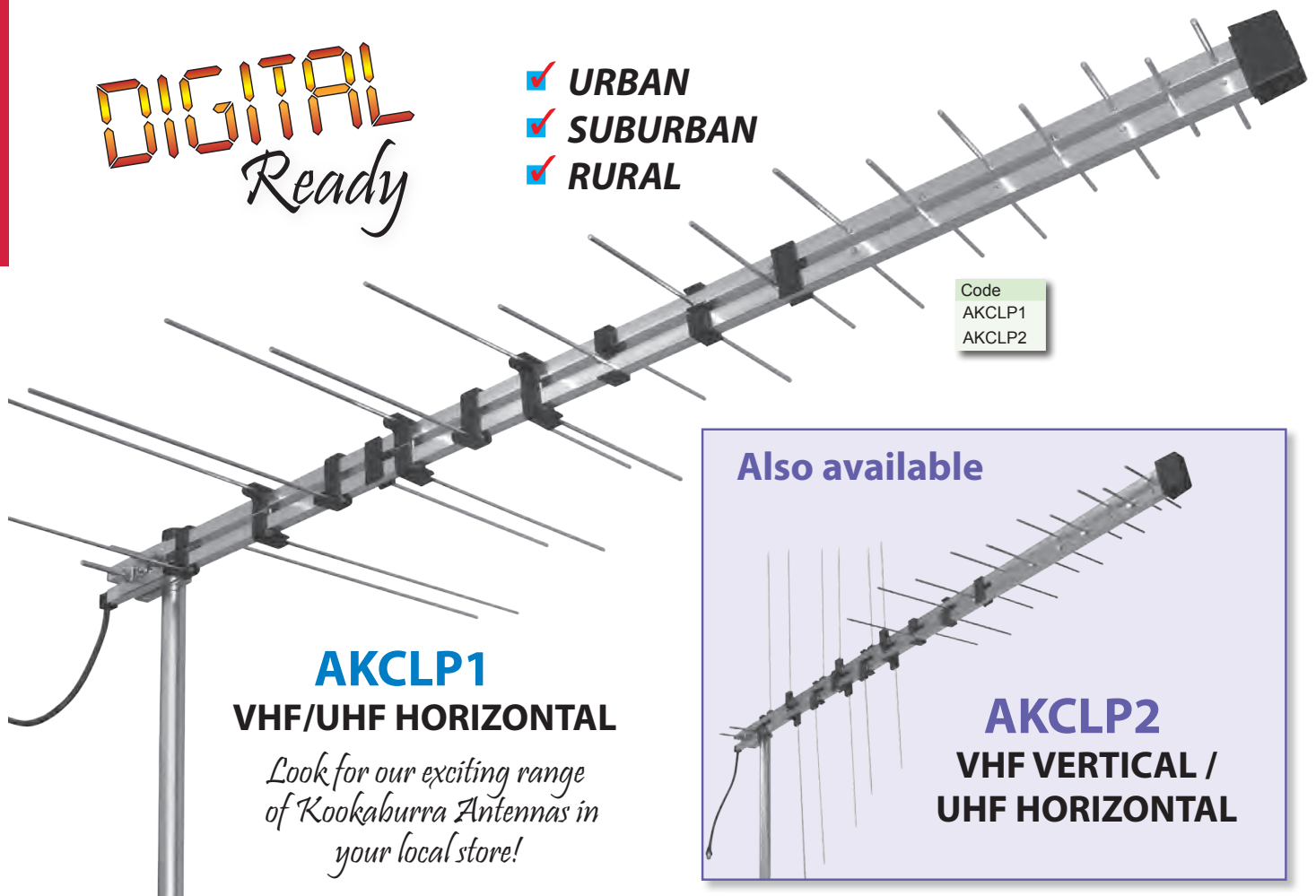
**AKCLP1****VHF/UHF HORIZONTAL**

*Look for our exciting range  
of Kookaburra Antennas in  
your local store!*

Also available

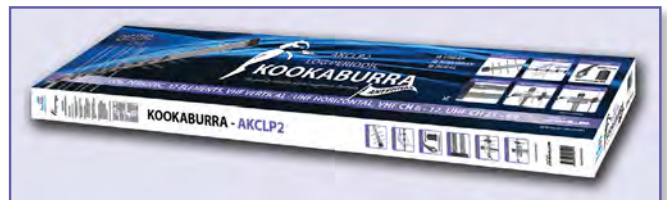
**AKCLP2****VHF VERTICAL /  
UHF HORIZONTAL**

**LOG PERIODIC, 32 ELEMENTS,  
VHF CH 6 - 12, UHF CH 21 - 69**



Model #AKCLP1 & 2

# KOOKABURRA™

*Designed & tested for digital reception in Australia*



FEATURES

- 32 Elements
- Foldable Elements for easy installation
- Durable UV resistant black plastic
- Designed for Horizontal or Vertical polarities (Universal Mount included)
- Weatherproof F – connector with rubber seal
- Superior design providing reception of Digital television channels for VHF (Band 3) and UHF (Band 4 & 5)
- Robust construction

SPECIFICATIONS

Specifications	Code: AKCLP1	Code: AKCLP2
Elements	32	
Channels	VHF 6 - 12, UHF 21 - 69	
Frequency	174 - 900 MHz	
Antenna Gain	6.0 - 13 dB, 11 - 13 dB	
Beam Width		
Horizontal	H 70° - V 120°	H 70° - V 120°
Vertical	NA	H 39° - V 54°
Front to Back Ratio	VHF 12 - 16 dB UHF 16 - 19 dB	
Impedance	75Ω	
Length	1205 mm	

F - Connector



Robust Construction



32 Elements

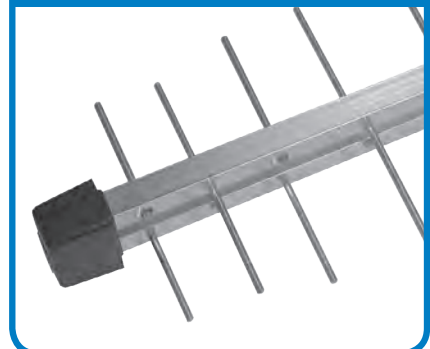

Vertical Mounting

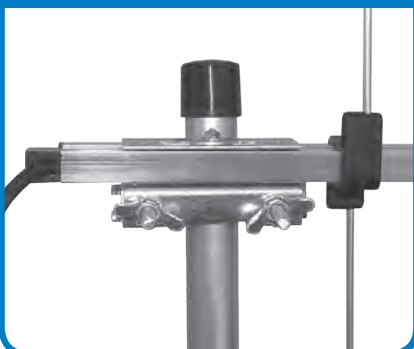

Horizontal Mounting

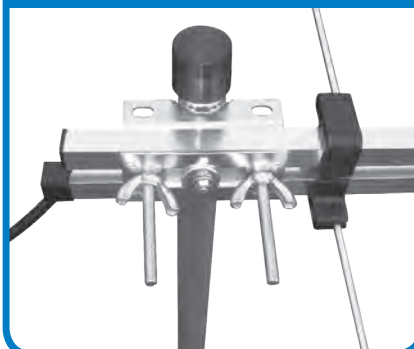

Foldable Elements

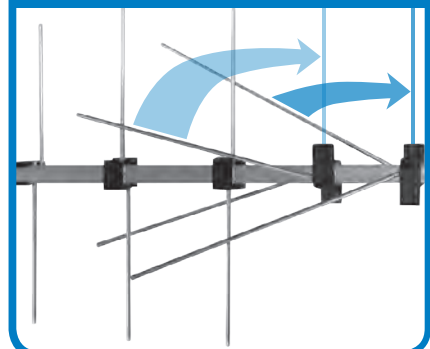



## WIRED REMOTE EXTENDER

Enjoy the freedom of operating your Home Entertainment device from anywhere in the home or office!

These remote extenders have been designed specifically for wired infrared operation. Control multiple AV devices from another location within your home or office via the coaxial cable. The small stylish Transmitter and Receiver can be hidden away with the emitter receiving eye only in view for operating the desired AV device.



### FEATURES

- LED IR indicators
- Wall mountable option.
- Includes low voltage power adaptors.
- Suitable to work with all remote controls.
- Output level control for IR signal strength adjustability.
- Fitted with PAL connections for simple DIY installation.
- Receiver and Transmitter can be concealed out of sight.

Code  
BPWMH

NOTE:- One Transmitter & One Receiver included in above kit

ADDITIONAL RECEIVERS  
SUPPLIED 2Pcs PER PACK

Code  
BPWMH1

**FOXTEL  
Compatible**

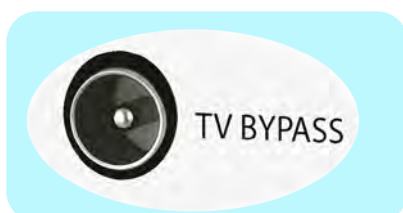

Fitted With  
PAL Connector



Wall Mounting



Level Control  
& IR Indicator

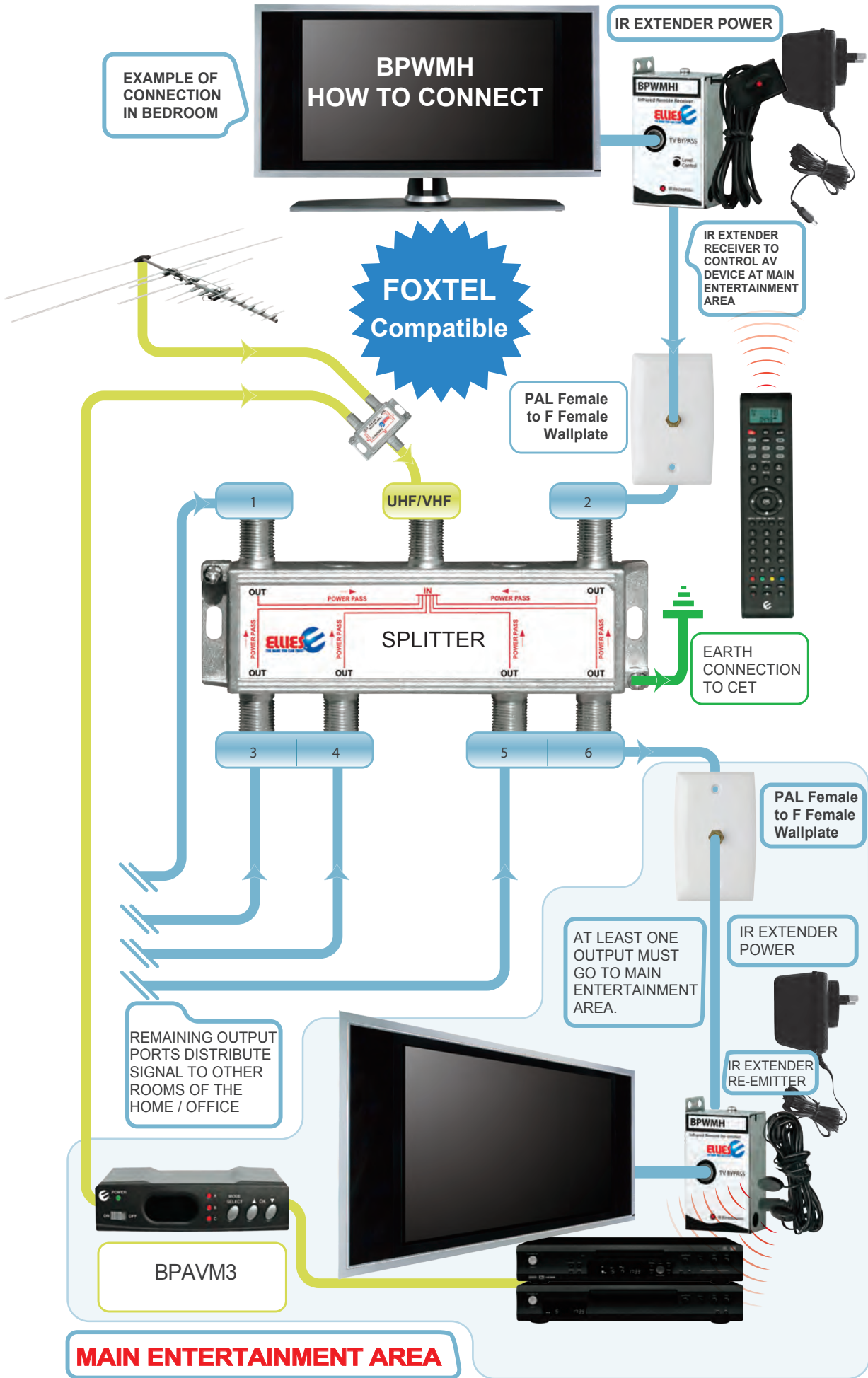

# RF Modulators

UHF

## BPAVM3

SUPPLEMENT - NEW PRODUCTS



Code  
BPAVM3

Product Code	Description
BPAVM3	RF Modulator, 3 x Audio Video Inputs, UHF RF Output, Ch. 21 to Ch. 69, Video Blaster

### Convert the composite output from your Security Camera, DVD, Pay TV, STB etc, to your old existing TV or alternatively distribute the RF signal throughout your entire TV system!

This RF Modulator has the ability to combine three Composite Audio Video signals into one single UHF RF output. This device is perfect for home/office and commercial applications. This unit offers a wide choice of channel selection in the UHF band, channel 21 through to channel 69. Any single channel can be selected to suit the user's application.

This unit is especially useful when older style equipment does not feature line level audio video inputs, ie: some makes and models of VCRs, TVs etc. The BPAVM3 can be used with all AV Devices or Video Cameras that have an Audio (Mono L+R) and Video Composite Output.

#### Features

- Small Modern & Compact Housing
- 3 x Composite Audio Video Inputs
- High Stability using PLL Technology
- Converts Composite AV (Audio Video) to RF (Radio Frequency) Signals
- This unit is suitable but not limited to the Distribution of a VCR, DVD, CCTV, Digital TV, Pay TV, Video Cameras (CCTV) and Video Game Consoles
- Allows AV Output Devices to be Distributed Throughout the Home/Office via Coaxial Cable
- Select the desired UHF Channel Output
- Easy to Install into the Existing Antenna Installation
- Level Adjustment
- LED 2 Digit Channel Display
- On/Off Switch with Power Indicator
- MOD (Mode) Select Key & Channel Up/Down Keys
- Energy Efficient with Low Voltage Power Adaptor

#### Specifications

Frequency Range	UHF: 470 to 862 MHz
Max. Output Level	85 dB $\mu$ V
Output Level Adjust	20 dB $\mu$ V
Channels	3
Inputs	Video via RCA (Composite) Audio via 3.5mm (R+L Mono) 3 pin
Output	RF via F Female
Operation Environment	Indoor
Power Adaptor	9 VDC @ 300 mA
Dimensions	133 mm x 90 mm x 34 mm

#### AUDIO/VIDEO (3 INPUTS)

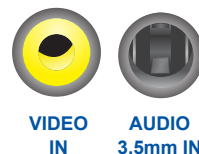

#### RF OUT



Please refer to the next page for more information and connecting options on this product



# SETUP OPTION

Allows the Connection of up to 3 x AV Composite Output Devices, to Multiple TV's with an RF Input

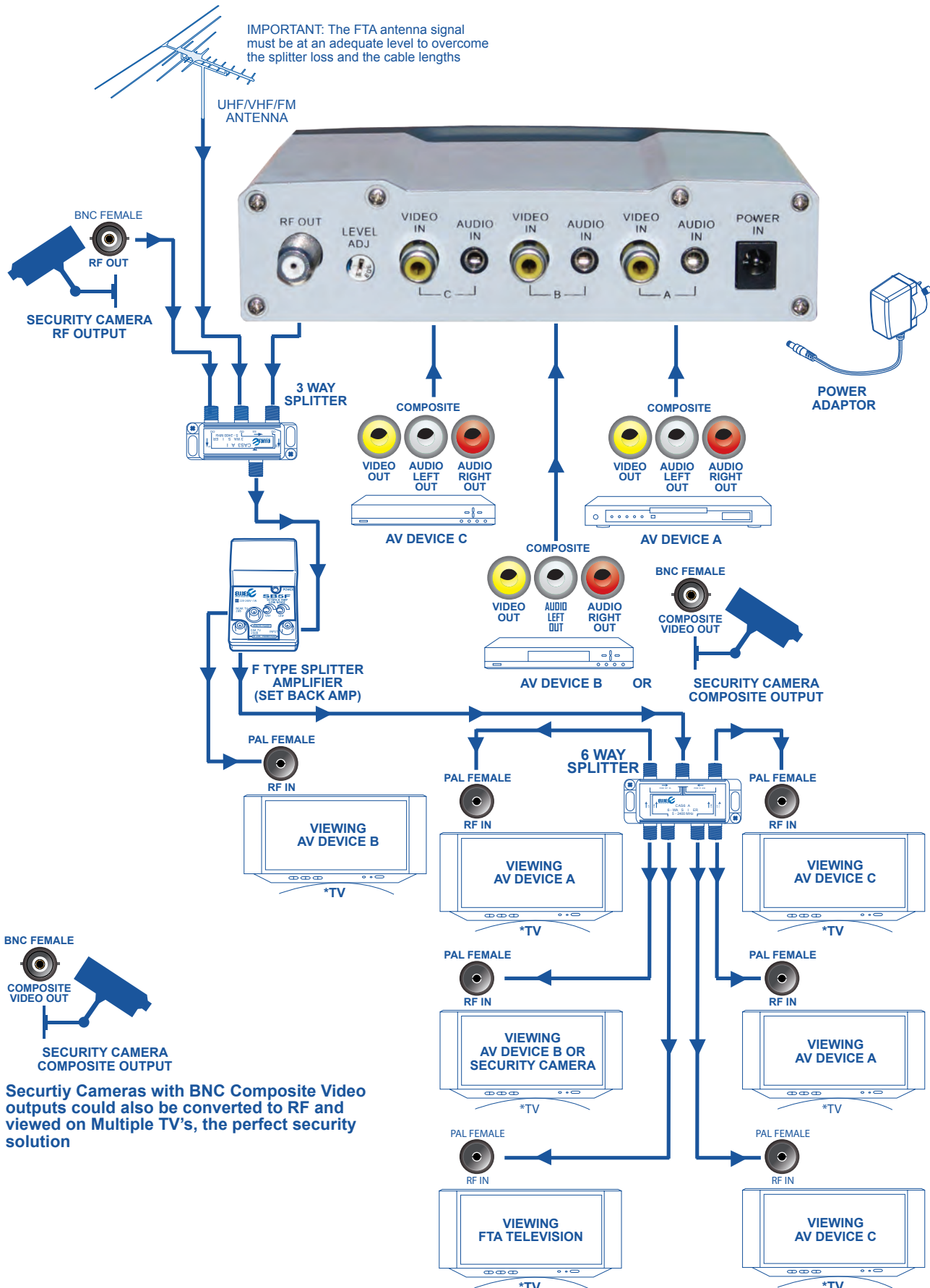

SUPPLEMENT - NEW PRODUCTS

## HDMI VGA COMPOSITE PC AUDIO WALLPLATE

### AUDIO AND VIDEO

Connect your HDMI, VGA, 3.5mm Audio and RCA cables from your desired source.

- 1 x VGA Female to Female
- 1 x 3.5mm Audio socket
- 1 x HDMI Female to Female
- 1 x Video/Stereo Audio RCA Female to Female yellow/white/red

Code  
PRO1310



## USB VGA PC AUDIO WALL PLATE

### USB 2.0

Connect your VGA, 3.5mm Audio and VGA cables from your desired source

- 1 x VGA Female to Female
- 1 x 3.5mm Audio socket
- 1 x USB Female to Female

Code  
PRO1314



## VGA, COMPOSITE AV, USB PC AUDIO CLIPSAL WALLPLATE

Connect your USB, VGA, 3.5mm Audio and RCA cables from your desired source to wall.

### Features

- 1 x VGA Female to Female
- 1 x 3.5mm Audio socket
- 1 x USB Female to Female
- 1 x Composite RCA Female to Female

Code  
PRO1309



## WALLPLATES WITH INSERTS

### CLIPSAL® COMPATIBLE

Comprehensive range of sockets that fit empty wall plates for a custom solution.

See Section 09 Page 6

### HDMI SOCKETS

See Section 16 "HDMI"



## 24 VOLT 500mA SWITCH-MODE POWER PACK

### 2.1mm POSITIVE TIP

Overload Protection Short circuit proof, etc. Very energy efficient. 100-240Vac input Stable voltage regulated output.

Voltage 24 Vdc  
Current 500mA  
Size 2.1mm  
Plug Pos.TIP  
Code SMP500-24P



## 10V 1A AC LINEAR

Alternating Current Output

Type Plug Code  
AC 2.1mm ACA1010



## 12V 2A POWER PACK

21mm Positive Tip

Voltage 12V  
Current 2A  
Code SMP12V2A21P



**'LEAD FREE' ROOF FLASHING SYSTEM**

**WATERPROOF ADHESIVE SURFACE**

A unique pre-fabricated roof installation flashing manufactured using a Wakaflex base. Available in 2 sizes to suit most installation sizes, Flashtites are available in lead grey and can be painted to suit any background colour if required. Adhesive surface, easy installation. Supplied with 1M double sided tape.

- Non toxic
- No painting necessary
- Quick and simple to install
- Non corrosive • Light weight
- Integral Adhesive System

Size	Code
280x450mm	FTG540
370x500mm	FTG20125



**VIDEO COMPRESSION PLUG**

**GOLD PLATED**

High quality gold plated compression plug. Supplied with 6 colour rings for identification.

Plug	Cable	Code
RCA MALE	RG59U	P386
RCA MALE	RG6QUAD	P387
BNC MALE	RG59U	P646
BNC MALE	RG6QUAD	P647



**12V UNIVERSAL USB 2.0 ADAPTOR SOCKET**

**UNIVERSAL TYPE**

12V Powered adaptor socket with USB input. To connect to USB head unit input socket including Ipod compatible models. Illuminated, Replaces most standard cigarette lighter sockets. 2M lead length.

Code
APUSBD2

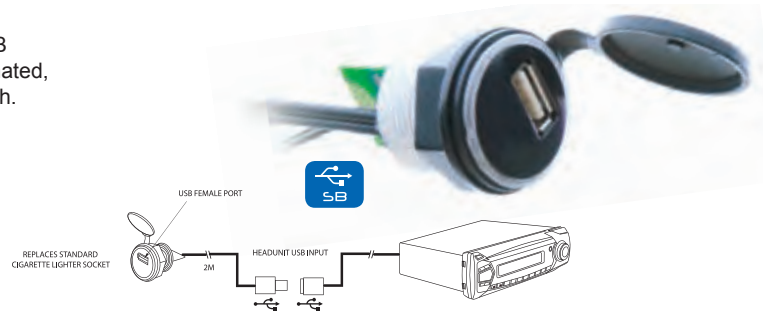

**FOLDING RADIO REMOVAL KIT**

**36 FUNCTION TWIN SET**

Clip design protects tools. Easier to grip than plain wires. Suits vehicles with Clarion, Sony, Blaupunkt systems.

Code
HT8048



2 Pcs/Pack

**TORX / TORX PLUS TAMP SET**

**300mm INTERCHANGEABLE**

7pcs Screwdriver set with double ended interchangeable 300mm blades. One end Torx® (Sec) (6 sided), other end Torx Plus® . (Sec) (5 sided). Sizes T10 | T15 | T20 | T27 | T30 | T40.

Code
HT9342



300mm long

SUPPLEMENT - NEW PRODUCTS



## 2 STATION WIRELESS INTERCOM

### NO WIRING OR BATTERIES NEEDED.

These intercoms are ideal for communication within your home or office. They communicate using Power Line Communication technology, which means that no additional cabling is needed. These can also be used as a baby monitor by pressing the lock button on the unit.

Code  
L88883

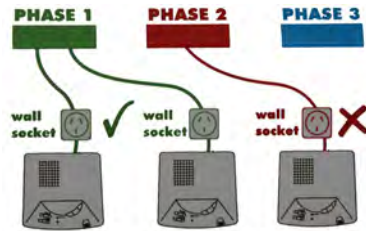

WALL SOCKET



WALL SOCKET

## 3W ALUMINIUM TORCH

### ULTRA BRIGHT FLASH LIGHT

High quality aluminium body, finished in black. Very light weight and perfect for everyday use. Measures approx 104mm in length and 33.5mm in diameter. A single high power Cree 3W LED, powered by 3xAAA batteries(not included).

#### Specifications

Focus function  
Bulb: CREE 3W  
Pushbutton tailcap switch  
Powerful Projecting LED Beam  
Compact, Pocket Size Design  
Change to 100% light, 50% light  
Flash setting by double pressing push button.

Code  
BRITELITE



## 3W ALUMINIUM HEAD TORCH

Features a high quality aluminium body finished in black. The integrated focus system allows you to change between a broad spotlight and a sharply focused long-distance beam by sliding the LED lens.

#### Specifications

Swivel head  
Powerful 3 watt LED beam  
Detached battery pack  
Luminous flux: 90 Lumen  
Beam range: 20 m approx.  
Battery: 3x AAA (not included)  
Adjustable beam intensity (zoom in and out)  
Size: 60 x 55 x 45 mm

Code  
HEAD3W



**FOUNTEK JP2.0 RIBBON TWEETERS - SOLD IN MATCHED PAIRS**

**5" ULTRA-THIN VERTICAL RIBBON TWEETER MATCHED-PAIR**

This is a vertical, double height version of the traditional JP3.0 unit. Super-Thin 0.009mm aluminium strip in a double height optioned package. Super-strong Neodymium offers extra efficiency and linear field density. Extremely thin diaphragm for maximising signal fidelity and extra response Low distortion factor, good power-handling capabilities, flat impedance. High linear impedance and amplitude response over a very broad range. Attractive silver rough-finish aluminium face plate with rubber grommet. Quality polycarbonate package with low stray flux for close to TV use. Recommended minimum crossover frequency is 2KHz 3rd Order (-18dB) Higher crossover frequency will give higher system total power handling Ribbon mass 25mg, 960mm<sup>2</sup> 8x120x0.009mm Super strong 0.6 Tesla Neodymium magnet Impedance 7 Ohm, DC 0.02 ohm [Beware!] Sensitivity 98dB  
1.4KHz to 40KHz and above  
Resonance frequency 440Hz  
Power 17W Normal, 40W Max  
Fascia 150x70mm Silver  
Ultra-thin aluminium 5" (120mm) Ribbon Pair:



**FOUNTEK JP2.0 RIBBON TWEETERS - SOLD IN MATCHED PAIRS**

Colour	Code
Black	JP2.0BK
Silver	JP2.0SL

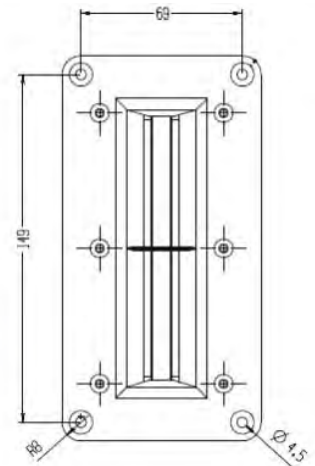
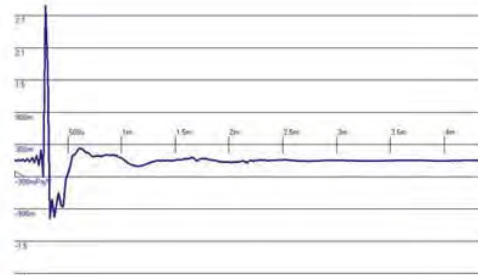
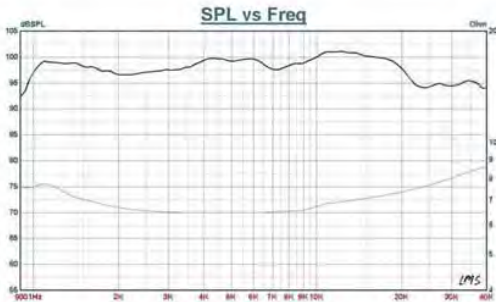

**FOUNTEK RIBBON TWEETER RANGE**

Description	Round Traditional	Round Coated	Vertical 120mm Traditional	Vertical 145mm Coated
Size	110mmØ	110mmØ	85x165mm	115x190mm
Sens.	95dB	95dB	98dB	102dB
Impedance	7Ω	7Ω	7Ω	7Ω
Pmax	40W	40W	60W	120W
Prms	14W	17W	20W	60W
Freq.	1.7K-40KHz	1.4K-40KHz	1.4K-40KHz	1.5K-40KHz
Crossover	4.5KHz (18dB)	3.8KHz (18dB)	2.5KHz (18dB)	1KHz (18dB)
Code	JP30	NEOCD30	NEOCD2.0	NEOPRO5I

A thin, light metal ribbon is suspended in a powerful magnetic field. The signal current passes directly through this ribbon effecting the field thus the electromagnetic circuit has complete control over the ribbons motion. Every part of the ribbon is driven directly and simultaneously without any energy storage or mechanical restriction or material influences, so the output sound will always perfectly replicate the input signal. This maintains the leading edge of musical sounds and their harmonics. Extremely low intermodulation and harmonic distortion due to low mass. For the purists there is the genuine 9µM ribbon. The Neo Series uses 20µM Sandwich Ribbon. with extra strength & reliability, no oxidation, & controlled dampening.



[www.fountek.com.au](http://www.fountek.com.au)



SUPPLEMENT - NEW PRODUCTS

**DIGITAL AUDIO EXTENDER OVER CAT6****COAXIAL OR OPTICAL DIGITAL AUDIO UP TO 150M**

The Digital Audio Repeaters are useful for sending the digital audio signal up to 150m away at high quality. The units can switch between Coaxial and Optical digital signals and can be powered by either USB or power adaptor allowing users flexibility of choice between power sources.

**Features**

Supports Coaxial or Optical digital audio S/PDIF signal.  
Supports industry standard Category 5/5e/6 cable.  
Digital audio S/PDIF performance sampling rate 96 kHz.  
Supports single Coaxial input to Coaxial signal output.  
Supports single Optical input to Optical signal output.  
Supports stereo and multi-channel (7.1, DTS, Dolby Digital etc.) digital audio.

**Specifications**

Input Port - 1x Coaxial, Optical and CAT6.  
Output Port - 1x Coaxial, Optical & CAT6.  
Sample Rate - 32/44.1/48/88.2 & 96 KHz  
Power Supply - 5V/1A DC.  
Dimensions - 22x70x50mm.  
Power Consumption - 2W(Max)  
Weight - 80g/ each

Interface	Input	Output	Max. Code
TX/RX Kit	Coax/Optical	Coax/Optical	150 CH304TXRX

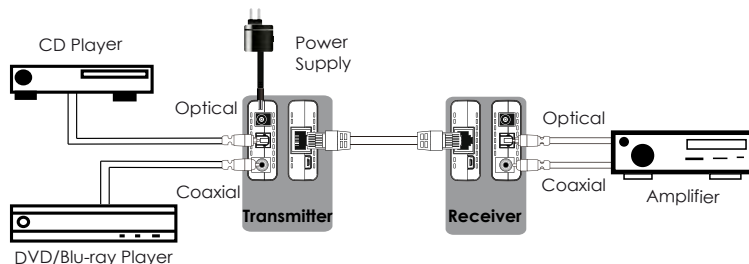
**VGA EXTENDER CAT5 [300M]****AUDIO & VIDEO OVER CAT5**

Easy CAT5 wiring solution SXGA 1280X1024, 60Hz. Used in pairs transfer audio and video up to 300M. Video image brightness/sharpness adjustment gives you high quality video effect. VGA, SVGA & SXGA compatible with super interference suppression, built in surge protection and anti-ground potential difference. HD15 male input. HD15 female output, With an extra HD15 output on each transmitter and receiver end to connect extra display unit. 2x Power packs, 1.5M VGA male to male cable, 1.5M 3.5mm male to male stereo cable supplied Requires CAT5 cable.

Code  
VGA300

**CYPRESS****CYPRESS 2011/2012 CATALOGUE MULTIMEDIA SOLUTIONS**

Cypress Technology, manufactures of Innovative AV and Multimedia products for Home, Office and Commercial Applications, have just released their latest Product Catalogue.

**PRODUCT SOLUTIONS INCLUDE:**

AV Extenders / Distribution Systems  
Video System / Format Convertors  
Audio Devices & Convertors  
Switches & Splitters Matrix Devices

**DOWNLOAD FREE PRINTED HARD COPY**

Printed catalogue is also available.  
Catalogue Order Code is: CYPCAT



**UNIVERSAL AC REMOTE CONTROL**

**SUITS 1000 MODELS OF AIR CONDITIONERS**

Big LCD install with built in real time clock and timer on/off function. Digital Auto search or manually input code for convenient set-up. ON/OFF timer & fast cooling and fast heating function. 8M operating distance. Requires 2 x AAA batteries (not included). size:- 152 x 50 x 24 mm.



Code AIRCO3



**4 WAY STEREO AUDIO VIDEO SELECTOR SWITCH**

**WITH 3.5mm HEADPHONE OUTLET**

4 input & 1 Output ports with composite video & stereo RCA and S-Video. Easy to switch the audio and video signal of four connected sources to one receiver. Connect your DVD, Set-Top box, TV, Stereo System & LCD,TV, etc. 1x3.5mm stereo headphone connection. Dimensions :- 200x113x45mm.

Type Code  
4 Way AV210



**COMPONENT TO RGBHV CONVERTER**

**YUV COMPONENT TO VGA CONVERTER**

User can select either Auto or Manual signal detection. Unit is selectable between 480i/576i or 480p/576p. Sync Output select switch. Inputs 3xRCA jacks. Y:1 Vp-p, 75 ohm. Pb/Cb:0.7 Vp-p, 75 ohm. Pr/CR:0.7 Vp-p, 75 ohm. Output 1xVGA. 0.7Vp-p R.G.B 75 ohm. 15 pin D Female Connector. Power Supply included. Size : 287X140X45mm

Code CM-343



**BNC CRIMP RG179/RG59 MINI**

**BNC MALE PLUG**

Cable : RG179, RG59 Mini, RG179DT . Also suitable for 3mm and 4mm multicore coax cable.

Code BNC7003



**PANEL MOUNT SOCKET 2.5mm & 3.5mm**

**SOLDER TAG AUDIO SOCKET**

Size	Type	Code
2.5mm	Stereo (Not Switched)	J126
2.5mm	Mono (Switched)	J125
3.5mm	Mono (Switched)	J110



**WIFI USB DONGLE TP-LINK**

**TP-LINK WIRELESS LAN**

USB 2.0 Plug-N-Play WiFi adaptor. Inbuilt antenna & security. Stable Wireless Signals. Seamlessly compatible with 802.11b/g/n products.



Speed	Size	Code
54Mbps	87x24x10mm	TL-WN321G
150Mbps	37x17x9mm	TL-WN723N
300Mbps	86x26x12mm	TL-WN821N

**MODULATION DIODE**

**DAMPER + MODULATION DIODE**

High Voltage and high reliability. High speed switching modulation diode/Damper diode. Low conduction Loss. Designed for Horizontal deflection circuit in CRT TVs & Monitors.



Code F60B150DS

## WIFI MULTIMEDIA PRESENTATION SYSTEM WITH AUDIO / VIDEO

### NO MORE CABLE SWAPPING

Add the ARP-260 wireless adapter to any projector or other VGA type display to quickly and easily share visual presentations by audio and video over a convenient and secure wireless 802.11n connection. The ARP-260 communicates with the latest operating systems, including Windows, Mac, iPhone, Windows Mobile and transmits A/V at high speed WiFi 150 Mbps for impressive resolutions up to QXGA. The ARP-260 makes it easy to collaborate between staff, students, clients and guests. The Moderator and QuadView features allow multiple computers to connect to the display at the same time and let you have control over which computer (or computers) are displayed. Connect the ARP-260 to your network to also create a secure wireless access point to your network with MIMO. Powerful software included allows multiple security levels for you to control whether users have full network access, Internet access only, or neither (present only). The ARP-260 is an excellent multimedia solution offering professional versatility to share and display your audio visual presentations.



Turn any monitor or projector display with a VGA input into a wireless networked display quickly and conveniently  
 Connect and display multiple computers with central Moderator and QuadView collaboration control tools  
 802.11n for ultra-fast transmission of data, video and audio  
 On-board video decoding displays HD video seamlessly  
 Creates a secure wireless network access point with MIMO

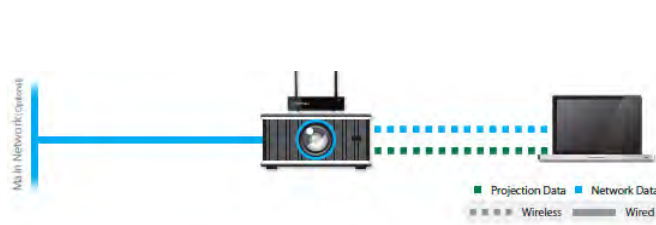

### Fast and Convenient Wireless Connection for Collaboration

#### High speed and long range

The latest 802.11n wireless technology gives the ARP-260 a fast transfer speed of 150 Mbps and has a reach of up to 300 feet (91 metres).

#### Seamless video

The ARP-260 has on-board video decoding, which means it does the heavy lifting instead of the computer. This produces fast and clean reproductions of video and audio even at high resolutions over the wireless network and from older computers with less processing power.

#### Control the display of multiple computers

The powerful Moderator feature allows a room full of computers to connect to a display and gives a "moderator" (via a web page) the ability to select which screen/s are displayed. Effortlessly switch presenters for seamless business collaboration. eg. Teachers can wirelessly connect their students' laptops and choose which student can display their work.

#### Four displays in one

The QuadView function allows you to display up to four connected computers at the same time – ideal for web meetings, collaboration and classrooms, etc.

#### Configurable to your organization

The ARP-260 is versatile. It can be used for simply wireless display only or configured into a secure WiFi network infrastructure access point adaptable to suit your requirements for multiple user and usages.

#### Multiple security levels

The ARP-260 maintains your security standards while giving multiple options for network and internet sharing. It complies with the latest security protocols, including WPA2-PSK.

#### Wireless presentation with access point

The ARP-260 can work as a MIMO network access point, which allows any wireless-enabled computer or mobile device to connect, present, and/or access other network resources. The Gatekeeper function can be set up to block all (display only), allow Internet access (display and get to the Internet) or allow all (display, Internet, and company network).

#### ARP-260 Presents through your IP Network

There's no need to switch wireless networks to present. Stay connected to your local network (for email, shared folders, etc.) then when you want to present – simply connect to the ARP-260, as easily as if it were a printer, and start presenting! Secondly, when configured, guests can also use the wireless access point functions to not only present but also access the Internet, all while keeping your local network assets private. Its easy and intuitive with the powerful software included with the package. Stay secure and versatile with the ARP-260.



**ARP-260 Specifications**

Connectivity: 802.11 b/g/n (2 dipole antenna for MIMO), RJ-45 (100Base-TX), VGA, 3.5mm audio out

Wireless Range: Up to 300ft / 91M

Data Rate: Wireless: Up to 150 Mbps and LAN: 10/100 Mbps

Output Resolutions: XGA (1024 × 768), WXGA (1280 × 768, 1280 × 800)

Input Resolutions: SVGA (800 × 600), XGA (1024 × 768), SXGA (1280 × 1024), WXGA (1280 × 768, 1280 × 800),

WSXGA (1440 × 900, 1600 × 1024), UXGA (1600 × 1200), WUXGA (1920 × 1200), QXGA (2048 × 1536)

Wi-Fi Compliant: 802.11 b/g/n with MIMO

Codec Decoding: MPEG1, MPEG2, MPEG4, DivX@3/4/5, Xvid, WMV 9, MP3, WMA

Security: IEEE Standard 64/128 bit WEP/WPA/WPA2-PSK

Display Output: Suitable with any display using a VGA (HD15) input connection.

**Software System Requirements**

ARP-260 Manager: Microsoft Windows (Win 7 32/64 bit, XP Service Pack 2, Vista 32/64 bit), Mac 10.4 and higher

Hardware: Pentium 1.5G 256MB RAM.

MobiShow: Windows Mobile 5.5 or higher and iPhone, iPod Touch, etc.

MirrorOp Send: Available for Android from marketplace. Compatibility depends on mobile device.

Presentation to Go: (PtG) Wireless: Up to 150 Mbps.

(PtG) Converter: Windows (Win7 32/64bit, XP Service Pack 2 or higher, Vista 32/64bit) Office 2003 or 2007.

Code  
ARP-260

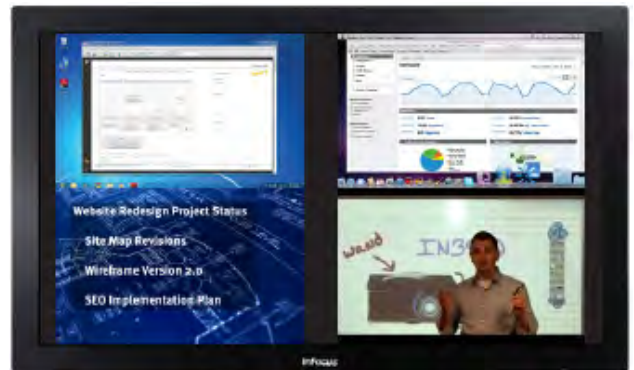



**6x9" CAR SPEAKER 3-WAY****EOSS**

6x9 (152mm x 228mm) 4 Ohm  
3 Way Speakers 250 Watts max  
Frequency Response: 60-20KHz  
Sensitivity: 90dB  
1" Voice coil 10 oz Magnet

Code  
APS6903

**4" CAR SPEAKER 2-WAY**

4" (102mm) 2 Way  
Speakers 120 Watts max  
Impedance 4OHM  
Frequency 70~20KHZ  
Sensitivity: 88dB  
Voice Coil 0.75"  
4 oz Magnet

Code  
APS42

**6x9" CAR SPEAKER 3-WAY**

Lightning Bolt Grille  
Polypropylene cone  
with brushed finish  
Rubber surround  
Mylar dome tweeter  
Mylar cone midrange  
Hardware, screws,  
1.8M x2 Cable  
55Hz to 20KHz  
Sens. 87dB  
Mag. 20.0oz  
Voice Coil 25mm  
Hole 220x150mm  
Grill 260x185mm  
Depth 80mm

Code  
APH69

**SPEAKER DRIVER GP**

Impedance 4Ω  
Power 5Wmax  
Size 120x40x120mm  
Code SP110

**4" SEALED-BACK MID-RANGE****PAPER CONE GP**

Size 100mm  
Impedance 8Ω (6.8Ωdc)  
Pmax 15W  
Sens. 92dB  
Freq. 330-6KHz(±3dB)  
Code MR4-15

**SPEAKER DRIVER TV**

Impedance 8Ω  
Suit Tempest, NEC, TVs, etc.  
Mag. 43 49  
Height 40 42  
Power 3W 5W  
Code SP138 SP140

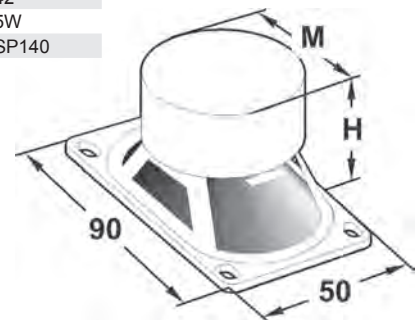
**SCAN-SPEAK 6½" MID-WOOFER ILLUMINATOR****NEODYMIUM UNDER-HUNG MOTOR SYSTEM**

The Illuminator midranges are based on compact under-hung motor systems with large neodymium ring magnets. The patent pending motor offers a very long linear excursion together with a very high force factor. The top plate is shaped to "guide" the backside airflow around the motor and with the very open cast-aluminium chassis design the driver is virtually free from compression and any turbulence type distortions.

Impedance	8Ω (Re 5.9Ω)	4Ω (Re 3.2Ω)
Power	80Wrms	80Wrms
Sens.	85.4 dB	87.2 dB
Fs	31.0Hz	30.0Hz
Le	0.41mH	0.50mH
Qms	3.51	3.56
Qes	0.37	0.32
Qts	0.33	0.29
Vas	48.6L	49.9L
Code	18WU/8741T00	18WU/4741T00

<http://www.scan-speak.dk>

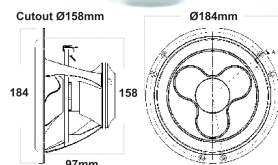
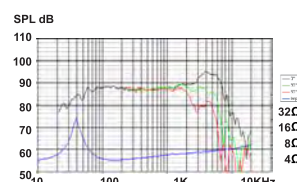

**FOOT SWITCH AC**

240V MAINS SWITCH  
 Plug to socket lead  
 With foot operated  
 switch in-line  
 Cord 1.8M

Colour	Code
Black	FS01B
White	FS01W



**VHS**

Brand	TDK	Sony
Time	180 min	180 min
Code	EHGE180	E180DXF1



**VHS-C**

Compact VHS Tape for video cam-corders.

Time	Code
30min	VHSC30
45min	VHSC45



**UNIVERSAL CRADLE**

**VENT CLIPS**

Mobile media holder  
 Suits phones, GPS,  
 iPods®, MP3, etc.  
 Clips into air-con  
 Expandable holding  
 padded jaws. 32-55mm  
 Quick release button  
 Hanging clear blister

Code
APH351



**12CM FAN SPECIAL**

**12Vdc LIMITED STOCK**

Sunon Ball raced  
 Two wire DC power  
 Plastic frame  
 High speed 31Krpm

Sunon	KD1212PTB1-6A
Size	120x120x25mm
Volt	12VDC
I	310mA
Power	3.7W
Airflow	90CFM
Noise	44.5dBA

Code
FAN1212



**AF CLEANING PRODUCTS**

**SEE SECTION 14**

A comprehensive  
 range of cleaning  
 products for computer  
 screens and television  
 displays. Non-scratch  
 and plastics safe for  
 todays flat screens.



**AF GEL SCREEN CLEANER**

**CLOTH & SPRAY**

New Anti-Static Screen  
 Cleaning Innovative and  
 highly effective screen  
 cleaning gel for use on any  
 type of screen from glass to  
 TFT, LCD & Plasma.  
 Includes 125ml Pump Bottle  
 10 Pieces non-woven cloths

Code
ASCG000



**AF CARD-CLENE**

**CARD SWIPE CLEANER**

Swipe Machine  
 Cleaners Sachet-packed  
 plain cards impregnated  
 with Isopropanol. Made  
 to ISO specifications.  
 Suggested for both card  
 entry readers and swipe  
 (Eftpos) readers  
 20 Sachets.

Code
CCP020



SUPPLEMENT - NEW PRODUCTS



## HAKKO FUME EXTRACTOR

Quiet operation and powerful suction.

Air-purifying fume extractor realizing powerful suction with quiet operation. Freestanding flexible ducts facilitate production changeovers. Three airflow levels are selectable according to working environments. Exhaust noise has been reduced without sacrificing suction performance by the addition of a silencer unit to the exhaust outlet to ensure smooth air outflow. A high-performance motor with 1,500 Pa of static pressure provides powerful suction and quiet operation. Accepts one or two ducting kits. Requires Ducting Kit.

Code  
FA430

### DUCTING KITS

As required by FA430. Includes firm adjustable goose neck hose and Nozzle.

Description	Code
Rectangular	HK1571
Circular	HK1572



HOSE KIT EXTRA

[http://www.hakko.com/english/products/hakko\\_fa430.html](http://www.hakko.com/english/products/hakko_fa430.html)

## UNIVERSAL LUBRICATING OIL

Professional quality machine oil. Suitable for lubrication of sewing machine, Zippers, Locks, Roller Bearing and other moving metal parts.

Size Code  
100ml OL100



## CLEAR SILICONE GREASE

Clear silicone multi-purpose grease for use on Switch contacts, Ignition systems, EHT high voltage connections, etc.

- \* High electrical insulation.
- \* Waterproofs / repels moisture.
- \* Excellent Lubricant.
- \* High temperature resistant.

Size Code  
50g GR2000



## TWIN WRENCH DRIVER SET

### MAGNETIZED TIP

Two bit holders which allows it to be used as a wrench or as a driver. Includes 1.5mm 2.0mm 2.5mm 3.0mm 4.0mm hex bits, #00 #1 #2 Phillips head bits, and 4.5mm, 6mm flat head bits. Knurled Cushioned Grip.

Code  
DR-07





# Digital TV Made Easy, COFDM-PAL Converter

## FRACARRO

### COFDM - PAL CONVERTER

Keep analogue TVs working after digital switchover



The Compact Line digital converter, from Italian manufacturer Fracarro, converts 6 digital SD channels back into analogue and may cost less than replacing all your TVs.

No new expensive digital TVs, no set top boxes, no confusing remote controls - just the TVs you use today!

If you have more than 10 TVs to replace, then you should be considering the Fracarro Compact Line. It is the ideal single unit system for hospitals, hotels, motels and retirement homes.



**600g DIGITAL SCALE****AUTO CALIBRATION CAPABILITY**

Highly accurate and precision digital scale, the art of measurement with five digit (including annunciator) back light display. Auto calibration capability. Auto power off. Exclusive microprocessor LSI-circuit, high reliability. Durable & portable housing plastic case.

**FEATURES**

600g measuring capacity with 0.1 g resolution.  
High precision Load Cell Transducer.  
LSI-circuit exclusive microprocessor.  
Full capacity tare function capability.  
Net weight, gross weight display.  
With counting scale function.  
Auto calibration capability.  
Gram or pound display.

**SPECIFICATIONS**

Measuring Capacity. 600 g/21.12 oz.  
Resolution . . . . . 0.1 g/0.005 oz.  
Min. Display Weigh . . . . . 0.3 g/0.015 oz.  
Accuracy . . . . .  $\pm 0.1\%$  +2 digits  
Sampling Time . . . . . Approx. 0.8 second.  
Over Load Indicator Show " EEEEEE ".  
Cabinet Size . . . . . 150 x 145 x 48 mm.  
Platform Size . . . . . 195 x 150 mm.  
Power Supply . . . . . 6 x 1.5V AA Batteries (Not included)  
. . . . . or DC 9V adapter (Not included).

Code  
GM-600G

**3KG DIGITAL SCALE****EXCLUSIVE LSI-CIRCUIT**

Highly accurate and precision digital scale, the art of measurement with five digit (including annunciator) back light display. Auto calibration capability. Auto power off function. Exclusive microprocessor LSI-circuit, high reliability. Durable & portable housing plastic case.

**FEATURES**

3000g measuring capacity with 1g resolution.  
High precision LOAD CELL transducer.  
Use exclusive LSI-circuit microprocessor.  
Full capacity tare function capability.  
Net weight, gross weight display.  
With counting scale function.  
Auto calibration capability.  
Gram or pound display.  
Back light LCD display.

**SPECIFICATIONS**

Measuring capacity 3000g/6.6 lb.  
Resolution . . . . . 1g/0.002 lb.  
Min. Display Weight 3g/0.006 lb.  
Accuracy . . . . .  $\pm 0.1\%$  +2 digits.  
Sampling Time . . . . . Approx. 0.8 second.  
Tare Control . . . . . Full capacity.  
Over Load Indicator Show " EEEEEE ".  
Cabinet Size . . . . . 150 x 145 x 48 mm.  
Platform Size . . . . . 195 x 150 mm.  
Power Supply . . . . . 6 x 1.5V AA batteries (Not included),  
. . . . . or DC 9V adapter (Not included).

Code  
GM-3KG

**MAINS POWER PACK TO SUIT GM SERIES DIGITAL SCALES****OPTIONAL 9V DC POWER PACK**

9V DC switch mode power pack with removable plug. Requires FSR04

Voltage	Amps	Code
9Vdc	600mA	SMP600-9R

**2.5mm DC PLUG REVERSIBLE**

Plug	Code
DC 2.5mm	FSR04



**5KG DIGITAL SCALE**

**5 DIGIT DISPLAY FOR 1g RESOLUTION**

Highly accurate heavy-duty digital scale with five digit. Back light display. Auto calibration at power-on. Auto power off function. Exclusive microprocessor LSI-circuit. High reliability. Durable metal platter. Battery powered or DC 9V adapter power supply (Not included).

**FEATURES**

- Microprocessor circuit with high accuracy & better performance.
- High resolution & wide measuring capacity, 5,000 g x 1 g.
- Large LCD display, 18 mm ( 0.7" ) digit size, easy read out.
- Gram or Oz display unit, select by the internal slide switch.
- Built-in self calibration system, high precision.
- Heavy duty ABS housing plastic case.
- Load cell Transducer.

**SPECIFICATIONS**

- Measuring Capacity 5,000g.
- Resolution . . . . . 1g.
- Min. Display Weight 3g.
- Accuracy . . . . . ± 0.3% +1 digit.
- Sampling time . . . . . Approx. 0.8 second.
- Tare Control . . . . . Full capacity.
- Cabinet size . . . . . 250 x 188 x 70 mm
- Platform . . . . . 185 x 185 mm.
- Unit Select . . . . . g or oz, select by internal slide switch.
- Power Supply . . . . . 6 x 1.5V AA battery (Not included),  
or DC 9V adapter(Not Included).

Code  
GM-5001

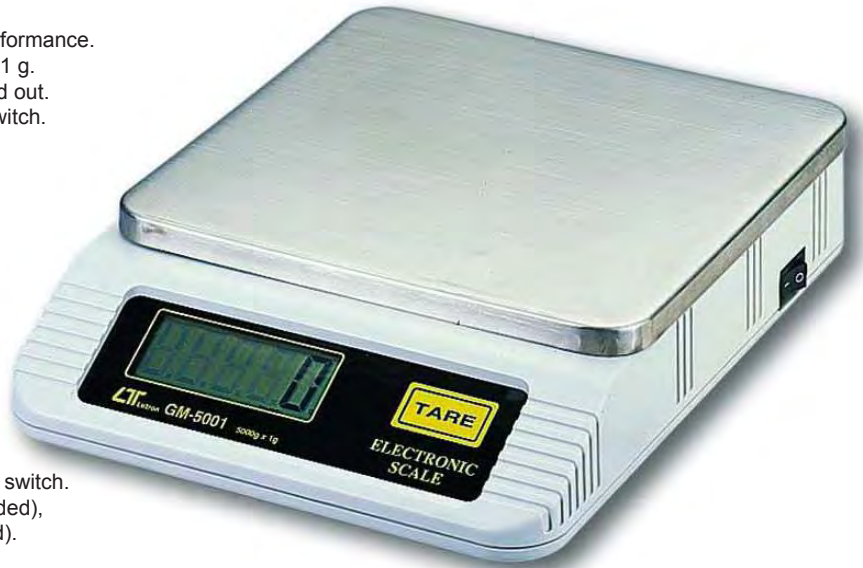

SUPPLEMENT - NEW PRODUCTS

**5KG DIGITAL SCALE RS232**

**RS232 INTERFACE**

Highly accurate heavy-duty digital scale with five digit. Back light display. Auto calibration at power-on. Auto power off function. Exclusive microprocessor LSI-circuit. High reliability. Durable metal platter. Battery powered or DC 9V adapter power supply (Not included).

**FEATURES**

- Microprocessor circuit with high accuracy & better performance.
- High resolution & wide measuring capacity, 5,000g x 1g.
- Large LCD display, 18 mm ( 0.7" ) digit size, easy read out.
- Gram or Oz display unit, select by the internal slide switch.
- Built-in self calibration system, high precision.
- Heavy duty ABS housing plastic case.
- With computer series data output.
- Data Bus RS-232 serial output, 9600 baud rate.
- Exclusive Microprocessor LSI circuit.

**SPECIFICATIONS**

- Measuring Capacity 5,000g.
- Resolution . . . . . 1g.
- Min. Display Weight 3g.
- Accuracy . . . . . ± 0.3% + 1 digit
- Sampling time . . . . . Approx. 0.8 second.
- Tare Control . . . . . Full capacity.
- Cabinet size . . . . . 250 x 188 x 70 mm
- Platform size . . . . . 185 x 185 mm.
- Power Supply . . . . . 6 x 1.5V AA battery (Not included),  
or DC 9V adapter (Not included).

Code  
GM-5000

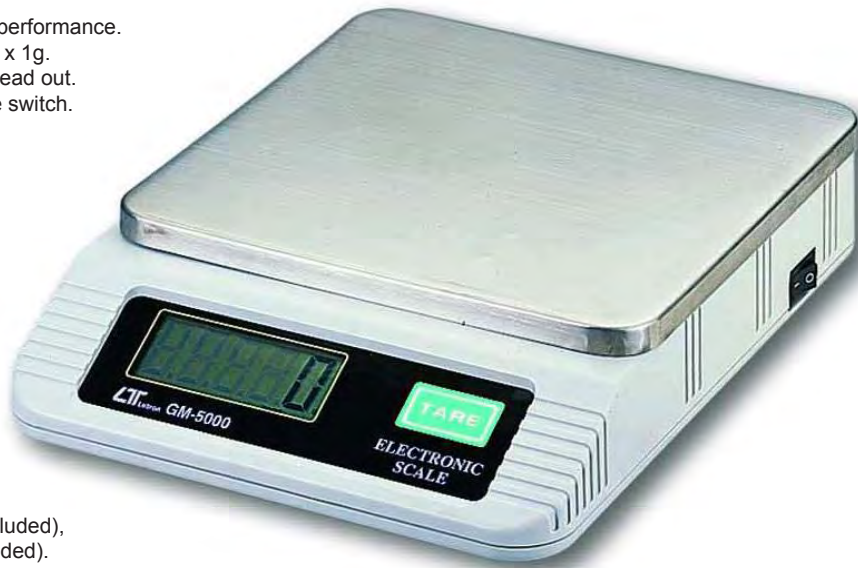



**600A DCA/ACA MINI CLAMP METER****EXTENDED FEATURE PROFESSIONAL****FEATURES**

High power 600Aac and 400Adc with extra ranges for an excellent all-purpose meter.  
Wide ranges clamp on current measurement both for ACA & DCA. Data hold button.  
Measurement for ACA, DCA, ACV, DCV, Ohms, Diode, Hz, Continuity beeper.  
Design meet IEC 1010 CATIII 600V safety requirement.  
Overload protection circuit is provided for all ranges.  
LSI circuit provides high reliability and durability.  
Pocket & slim housing case, easy carryout.  
4000 counts, Auto range & multi-functions.  
Compact & heavy duty ABS housing .  
Water resistance for the front panel.

**SPECIFICATIONS**

Display . . . . . 10.8 mm LCD, 4 digits.  
Polarity . . . . . Automatic Switching, " - " indicates negative polarity.  
Current Sensor . . . . . Hall effect sensor.  
Zero adjustment DCA Push bottom adjustment.  
Other ranges . . . . . Automatic adjustment.  
DCV /ACV Range . . . . . 400mV(DC only), 4V, 40V, 400V, 600V.  
DCA Range . . . . . 400A, 600A.  
ACA Range . . . . . 0.5 - 400A, 600A.  
Diodes . . . . . Short/non conductance, good/defect test.  
Ohms Range . . . . . 400Ω,4KΩ, 400KΩ, 4MΩ, 40MΩ.  
Frequency(5V) . . . . . 5Hz, 50Hz, 500Hz, 5KHz, 50KHz, 100KHz.  
Over-input . . . . . Indication of " 1 " or " -1 "  
Sampling Time . . . . . Approx. 0.35 second.  
Battery -: . . . . . 2 x 1.5V AA batteries (Not Included).  
Max. Jaw Open . . . . . 30 mm Dia.  
Dimension . . . . . 178 x 64 x 33 mm  
Weight . . . . . 230 g.

Code  
CM9940

**2000A DCA/ACA CLAMP+DMM****EXTRA HIGH POWER PROFESSIONAL TRUE RMS****FEATURES**

2 in 1 Deluxe unit with clamp meter + Digital multimeter.  
Meet IEC 1010 CATIII 1000V safety requirement.  
True rms reading for ACV & ACA measurement.  
4000 counts, Auto range, multi-functions for  
ACA, DCA, ACV, DCV, Ohms, Capacitance.  
Hz, Diode, Duty cycle and continuity check.  
LSI circuit provides high reliability and durability.  
2KAac and 400Adc clamp on current ranges  
4 ranges (400 uA, 4000 uA, 40 mA, 400 mA ) direct cur-  
rent input measurement both for ACA & DCA.  
Overload protection circuit is provided for all ranges.  
Data hold, Relative key, Back light.

**SPECIFICATIONS**

Display . . . . . 15 mm LCD, 4 digits.  
Measurement . . . . . ACA, DCA, ACV, DCV, Ohms, Diode, Hz, Capacitance, Duty cycle, Continuity.  
Polarity . . . . . Automatic Switching, "-" indicates negative polarity.  
Current Sensor . . . . . Hall effect sensor.  
Zero adjustment DCA Push bottom adjustment. Other ranges : Automatic adjustment.  
DCV / ACV Range . . . . . 400mV(DC only), 4V, 40V, 400V, 1000V.  
Direct Input . . . . . 400uA, 4000uA, 40mA, 400mA.  
Clamp On . . . . . 400A, 2000A .  
Ohms Range . . . . . 400Ω,4KΩ, 400KΩ, 4MΩ, 40MΩ.  
Capacitance . . . . . 50nf, 500nf, 5uf, 50uf.  
Frequency . . . . . 5Hz, 50Hz, 500Hz, 5KHz, 50KHz, 100KHz.  
Duty cycle . . . . . 1% - 99%.  
Diode . . . . . Short/non conductance, good/defect test  
Over-input . . . . . Indication of " OL " or " -OL "  
Sampling Time . . . . . Approx. 0.35 second.  
Battery . . . . . DC 9V battery(Not included).  
Dimension . . . . . 255 x 73 x 38 mm.  
Weight . . . . . 380g.

Code  
CM9930



**1000A DCA/ACA CLAMP METER**

**EXCELLENT VALUE**

**FEATURES**

- Measure max. 1000 A DCA or ACA by the inductive conductor, contactless.
- Economical cost with professional quality.
- Design meet IEC 1010 safety requirement.
- ACA, DCA, ACV, DCV, ohms, Diode.
- Built-in Data Hold function.
- LCD display, easy & clear readout.
- High internal impedance, assures min. measuring error.
- LSI-circuit provides high reliability and durability.
- Built-in low battery indicator.
- Overload protection circuit is provided for all range.
- Compact & heavy duty ABS housing plastic case.

**SPECIFICATION**

- Display . . . . . 13 mm LCD, 3 1/2 digits. Max. indication 1999.
- Measurement Range . . . . . ACA, DCA, ACV, DCV, ohms, Data hold.
- Current . . . . . Sensor Hall effect sensor.
- Zero adjustment . . . . . External knob, for DCA zero adjustment.
- Others . . . . . Automatic adjustment.
- Over-input . . . . . Display shows '1' or '-1'.
- DC Voltage . . . . . 200mV, 200V, 600V.
- AC Voltage . . . . . 200V, 600V.
- Resistance . . . . . 2000Ω.
- AC / DC Current . . . . . 200A, 1000A.
- Diode Check . . . . . Short/non conductance, good/defect test.
- . . . . . Approx. diode VF ( forward voltage ).
- Sampling Time . . . . . Approx. 0.4 second.
- Battery . . . . . DC 9V battery (Not Included).
- Dimension . . . . . 230 x 70 x 36 mm
- Weight . . . . . 400g.

Code  
DM-6046



**LIGHT METER + TYPE K/J THERMOMETER**

**SD CARD, REAL TIME DATA LOGGER**

After executing the Data Logger, just take out the SD card from the meter and plug it into the computer, it can down load all the measured values with the time information (year/month/date/hour/minute/second ) to the Excel directly, then the user can make further Data or graphic analysis by themselves. Sampling from 1s to 3600s (1Hr).

**FEATURES**

- 3 ranges, 2,000/20,000/100,000 LUX.
- LUX & Foot Candle unit selection with default.
- Auto range for light measurement.
- Spectrum of photo sensor meets C.I.E..
- Light measurement with zero adjustment by push button.
- Separate probe, easy for operation of different measurement environment.
- Type K, Type J thermocouple thermometer.
- RS232/USB PC COMPUTER interface.
- Real time SD memory card Datalogger.
- Manual datalogger is available.
- SD card capacity : 1 GB to 16 GB (Not Included).
- LCD with green light backlight, easy reading.
- Data hold, record max. and min. reading.
- LSI Microprocessor circuit, high accuracy.
- Powered AA x 6 batteries or DC 9V adapter (Not included).

**SPECIFICATIONS**

- Display . . . . . LCD with green backlight (on/off).
- Light Measurement . . . . . LUX, Feet candle ( Ft-cd ).
- Temp Compensation . . . . . Automatic temp.
- Type K/J . . . . . Thermometer °C or °F.
- Light Sensor . . . . . Exclusive photo diode & Colour correction filter.
- . . . . . Spectrum designed to Structure meet C. I. E.
- Zero Adjustment . . . . . By push button.
- Data Hold . . . . . Freezes the display reading.
- Sampling Time . . . . . Approx. 1 second.
- Data Output . . . . . RS 232/USB PC computer interface.
- Dimension . . . . . 177 x 68 x 45 mm.
- Weight . . . . . 489g.

Code  
LX-1128SD



SUPPLEMENT - NEW PRODUCTS



**DIGITAL THERMOMETER 4CH DATA-LOGGER****SD CARD, REAL TIME DATA LOGGER**

Displays up to four temperatures simultaneously. Real time SD memory card Datalogger, and Calendar, with sampling time setting from 1 second to 1Hr. Computer is not need to setup extra software, after execute datalogger, just take away the SD card from the meter and plug the SD card into the computer, it can down load all the measured values with the time information ( year/month/date/hour/minute/second ) to the Excel file then the user can make use of the data for graphic analysis by themselves.

**FEATURES**

Type K/J/T/E/R/S, Pt 100 ohm, measurement with 4 display.  
 Show 4 channels display on the LCD at the same time.  
 Offset adjustment for the Type K/J/T/E/R/S measurement.  
 Power by UM3/AA ( 1.5 V ) x 6 batteries or DC 9V adapter.  
 Microcomputer provides intelligent function & accuracy.  
 Real time SD memory card Datalogger.  
 RS232/USB PC COMPUTER interface.  
 Offset adjustment for the Pt 100 measurement.  
 Can default auto power off or manual power off.  
 Heavy duty & compact housing case.  
 Manual datalogger is available.  
 Innovation and easy operation.  
 Type K : -100 to 1300 °C.  
 Type J : -100 to 1200 °C.  
 Pt 100 ohm : -199.9 to 850.0 °C.  
 °C ( 0.1 degree ) / °F ( 1 degree ).

**SPECIFICATIONS**

Circuit . . . . . One-chip of microprocessor LSI circuit.  
 Display . . . . . LCD with green backlight ( ON/OFF ).  
 Resolution . . . . . 0.1°C/1°C, 0.1°F/1 °F.  
 Memory Card . . . . . SD memory card. 1 GB to 16 GB.  
 Automatic temp. compensation for type K/J/T/E/R/S thermometer.  
 Linear Compensation for the full range.  
 Data Output . . . . . RS 232/USB PC computer interface.  
 Power Supply . . . . . 6x 1.5 V AA battery or DC 9V adapter.  
 Dimension . . . . . 177 x 68 x 45 mm

Code  
 TM-947SD



SD CARD NOT INCLUDED



**Lutron**

Requires Temperature sensors (up to 4) and SD card (for data logging function).

**-40°C TO 250°C TYPE K THERMOCOUPLE SENSOR**

Ultra fast response naked-bead thermocouple suitable for general purpose Type-K Temperature readings.

Code  
 TP01

**-50°C TO 1200°C TYPE K THERMOCOUPLE PROBE**

Highly accurate & precise, type K thermocouple probe for temperature range -50°C to 1200°C with ±0.4% accuracy. Probe head size Ø8x120mm with 100mm long handle.

Code  
 TP03

**-50°C TO 900°C TYPE K THERMOCOUPLE PROBE**

Highly accurate & ultra compact, type K thermocouple probe for temperature range -50°C to 900°C with ±0.75% accuracy. Size Ø3.2x100mm.

Code  
 TP02A

**-50°C TO 400°C TYPE K SURFACE PROBE**

Highly accurate Type K thermocouple probe for temperature range -50°C to 400°C ±0.75% (+0.5°C) accuracy. Ø15x120mm.

Code  
 TP04





**OPTICAL 3D USB MOUSE**

**1000DPI Glide**

Low profile and compact, glide mouse has a sleek polished finish and discreet buttons coupled with a convenient scroll wheel. With USB interface the glide mouse offers exceptional pointing performance that would compliment any desktop. Compatible with Windows XP/7/Mac.

Code  
MOU213BK  
MOU213WH



**CLIPSAL COMPATIBLE VGA WALL PLATE**

**QUALITY PRODUCT**

Clipsal style 2000 series wall plate with VGA female to female and will accept 4 Clipsal inserts. Supplied with 4 blanks. White double face, easy to remove while painting.

Code  
WPI401



**AC/DC USB CHARGER**

**Dual USB PORTS 5V1.0A**

2 in 1 USB charger. AC/DC Multi-Purpose 2 Port USB Charger For Home & Car Use. 100VAC~240VAC 50/60Hz or 12VDC~24VDC input. 5VDC 500mA output. Adaptors for car and AC power socket. Size:- 70x70x25mm.

Colour White  
Plug Mains or Car  
Type USB A Twin  
Code USB901



**RECESSED 240V POWER OUTLET.**

**SINGLE OUTLET**

High quality single power outlet. Can be fitted standard 'C' Clip and Stud Brackets. Cut out 76mm x 52mm. Minimum depth for 10mm plaster 60mm or masonry 70mm. Appliance Outlet approval NSW 24133.

Code  
AV-RPS01



**A4 TECH USB SPEAKER**

**2.5Wx2 USB SPEAKER**

A4 Tech 2.5Wx2 Crystal Acrylic Faceplate USB Speakers. Hi-Fi stereo portable speaker 2.0 system. Unique lightweight, mini appearance. High performance full-range cone, neodymium driver, magnetically shielded. No driver needed, plug & play. USB power supply mode

Specifications:-  
Power output: RMS 2.5Wx2 (THD=10%)  
Signal-to-noise ratio (amplifier): >=70dBA  
Sensitivity: 88dB.  
Input port: Only USB input plug  
Frequency response: 80Hz-20kHz  
Driver unit: 4Ω, magnetically shielded  
Dimensions: 55x177x63mm.  
Weight: approx 1kg.  
Power input: USB power supply +5V

Colour Code  
Black SPK1020BK  
White SPK1020WH



**180KG FORCE SINGLE DOOR MAGNETIC LOCK****180KG FAIL SAFE HOLDING FORCE**

Heavy duty ultra safe & secure magnetic door lock with 180kg holding force capacity. Highly energy efficient 380mA at 12VDC; 190mA at 24VDC. Suitable for wood, glass, metal, fireproof door. Size:-170x32x21mm.

Code  
MDL1001

**280KG FORCE SINGLE DOOR MAGNETIC LOCK WITH LED****280KG FAIL SAFE HOLDING FORCE**

Heavy duty ultra safe & secure magnetic door lock with 280kg holding force capacity. With 0, 3, 6 & 9 sec fail safe time. Highly energy efficient 480mA at 12VDC; 240mA at 24VDC. Suitable for wood, glass, metal, fireproof door. Size:-250x42x25mm.

Code  
MDL1002

**280KG FORCE SINGLE DOOR MAGNETIC LOCK WITH MORTISE MOUNT****280KG FAIL SAFE HOLDING FORCE**

Heavy duty ultra safe & secure magnetic door lock with 280kg holding force capacity. Highly energy efficient 480mA at 12VDC; 240mA at 24VDC. Suitable for wood, glass, metal, fireproof door. Size:-230x38x26mm.

Code  
MDL1003

**360KG FORCE DOUBLE DOOR MAGNETIC LOCK****180KG FAIL SAFE HOLDING FORCE**

Heavy duty ultra safe & secure magnetic double door lock with 2x180kg(each) holding force capacity. Highly energy efficient 380mA at 12VDC; 190mA at 24VDC. Suitable for wood, glass, metal, fireproof door. Size:-340x35x21mm.

Code  
MDL1004

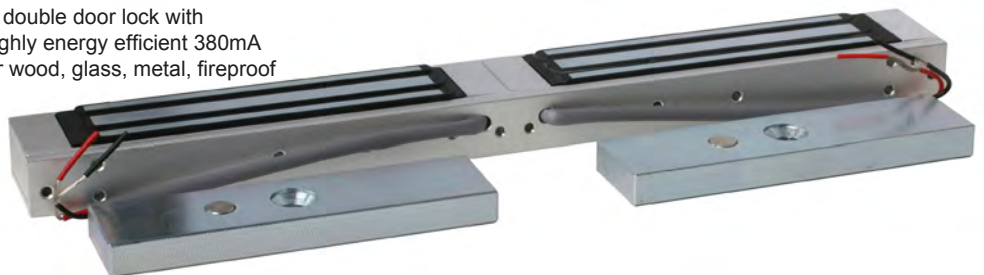
**560KG FORCE DOUBLE DOOR MAGNETIC LOCK****280KG FAIL SAFE HOLDING FORCE**

Heavy duty ultra safe & secure magnetic double door lock with 2x280kg (each) holding force capacity. Highly energy efficient 380mA at 12VDC; 190mA at 24VDC. Suitable for wood, glass, metal, fireproof door. Size:-500x42x25mm.

Code  
MDL1005





**CANVAS SLIP IN PROTECTIVE CASE FOR iPad, iPad2, iPad3**

**SHOCK PROOF**

Durable and convenient slip in case with protection against drops and shocks. Easy to insert or remove.

Colour	Code
Beigh	POU9060-101
Grey	POU9060-102
Sky	POU9060-105
Olive Green	POU9060-106
Pink	POU9060-107
Blue	POU9060-110
Army Green	POU9060-115



**OMO MICROFIBER LEATHER CASE FOR iPad, iPad2, iPad3**

**REVERSIBLE NEOPRENE**

New generic reversible neoprene bag allows you to choose the color which fits your mood or outfit. Provides Cushioning for your iPad and protect it from dust and scratches.

Colour	Code
White	POU9060-221
Black	POU9060-222
Red	POU9060-223
Yellow	POU9060-233



**SHOULDER STRAP LEATHER CARRY BAG FOR iPad, iPad2, iPad3**

**141cm STRAP**

Small grid design leather case with holder. Light weight, compact & easy to carry. Cushion your laptop and protect it from dust and scratches. Easy to insert and remove.

Colour	Code
Khaki	CAS9060-901
Green	CAS9060-906
Army Green	CAS9060-916



**CROCODILE SKIN FOLDING LEATHER CASE FOR iPad3**

**LEATHER PROTECTION**

Constructed from smooth, treated Leather that resists dirt and stains. Provides easy access to all functions without removing the case. Add a splash of color to your iPad.

Colour	Code
White	CAS9060-651
Black	CAS9060-652
Red	CAS9060-653



**WOOD SKIN PLASTIC CASE FOR iPad3**

**ULTRA PROTECTION**

Precision molded case for perfect fit to iPad. Covers the entire unit to prevent scratches and bumps. Easy access to all ports and connectors.

Colour	Code
Cream	CAS9060-301
Black	CAS9060-302
Brown	CAS9060-303



SUPPLEMENT - NEW PRODUCTS



**ULTRA THIN SMART COVER LEATHER CASE WITH HOLDER FOR iPad2, iPad3****WITH SLEEP / WAKE-UP FUNCTION**

In style ultra slim leather protective case with holder. It automatically wakes your iPad when open. It folds into a handy stand for reading & watching.

Colour	Code
Orange	CAS9060-214
Green	CAS9060-216
Pink	CAS9060-217
Blue	CAS9060-220
Black	CAS9060-222
Grey	CAS9060-224

**LEATHER SMART COVER WITH HOLDER FOR iPad2, iPad3****MAGNETIC ATTRACTION**

Tear resistant smart cover with anti dust and impact protection. Built-in magnets draw the Smart Cover to iPad for a perfect fit. Easy access to all ports and connectors.

Colour	Code
Grey	CAS9060-202
Red	CAS9060-203
Orange	CAS9060-204
Green	CAS9060-206
Pink	CAS9060-207
Purple	CAS9060-208
Blue	CAS9060-210
Black	CAS9060-212

**ULTRA THIN SMART LEATHER CASE FOR iPad3****SLEEP & WAKE-UP FUNCTION**

Automatically wakes your iPad when it's opened. It folds into a handy stand for reading, watching. Just stick your iPad on sticky side of case by removing the polyethene film. Ultra slim case looks smart not bulky.

Colour	Code
White	CAS9060-231
Red	CAS9060-233
Pink	CAS9060-237

**ULTRA THIN LEATHER / BACK PLASTIC CASE FOR iPad2, iPad3****SLEEP & WAKE-UP FUNCTION**

Thin, durable cover that magnetically aligns for a perfect fit. Automatically wakes iPad when you open it & it folds into a handy stand for reading, watching.

Colour	Code
White	CAS9060-451
Black	CAS9060-452
Pink	CAS9060-457
Blue	CAS9060-460



**TWO TONE ULTRA THIN LEATHER / BACK PLASTIC CASE FOR iPad3**

**ECO FRIENDLY MATERIAL**

Provides full housing protection. Protect your device from scratches, dirt, dust, damages. All controls and slots are fully accessible. Compact, light-weight, durable and dust resistant.

Colour	Code
Red	CAS9060-403
Purple	CAS9060-408
White	CAS9060-411
Black	CAS9060-412
Orange	CAS9060-414
Blue	CAS9060-415

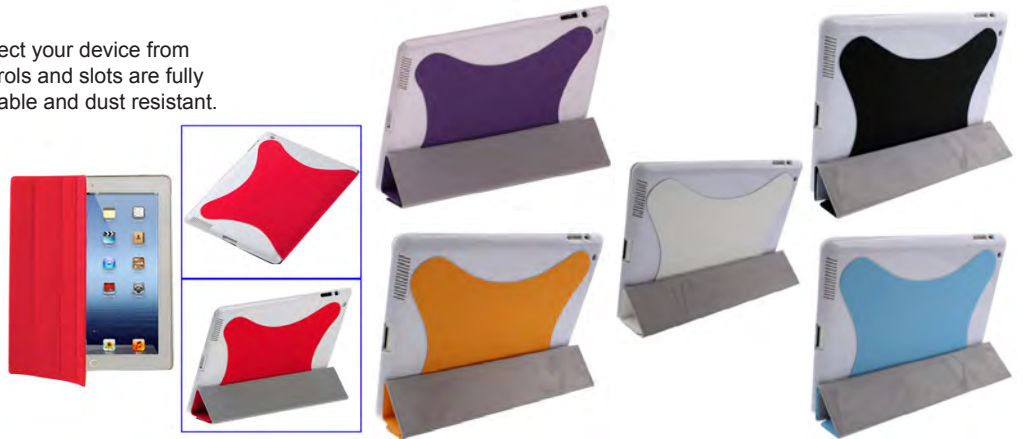

**SINGLE SIDE BALL TEXTURE SMART COVER FOR iPad2, iPad3**

**VIBRANT POLYURETHANE**

Wake your iPad or put it to sleep just by opening or closing the smart cover. Microfiber lining that keeps your display clean.

Colour	Code
Grey	CAS9060-282
Orange	CAS9060-284
Blue	CAS9060-285
Green	CAS9060-286
Pink	CAS9060-287
Black	CAS9060-289



**DOUBLE SIDED BALL TEXTURED SMART COVER FOR iPad2, iPad3**

**SLEEP & WAKE-UP**

High quality treated leather material with Anti-dust, Impact proof and tear-resistant property. Vibrant polyurethane or rich leather with a microfiber lining that keeps your display clean.

Colour	Code
Grey	CAS9060-261
Black	CAS9060-262
Blue	CAS9060-265
Green	CAS9060-266
Pink	CAS9060-267
Orange	CAS9060-264



**FLIP LEATHER CASE WITH BACK PLASTIC SHELL FOR iPad3**

**INNOVATIVE DESIGN**

Constructed from smooth, treated leather that resists dirt and stains. Provides easy access to all functions without removing the case. A splash of color with Impact protective and tear-resistant.

Colour	Code
Grey	CAS9060-171
Black	CAS9060-172
Red	CAS9060-173
Blue	CAS9060-175



SUPPLEMENT - NEW PRODUCTS



**360° ROTATABLE LEATHER CASE WITH HOLDER FOR iPad3****SLEEP & WAKE-UP FUNCTION**

360 Degree Rotatable innovative design. Provides easy access to all functions without removing the case.

Colour	Code
Blue	CAS9060-270
Black	CAS9060-272
Brown	CAS9060-274
Green	CAS9060-276
Pink	CAS9060-277
Purple	CAS9060-278
White	CAS9060-281

**360° ROTATABLE TEXTURED FLIP LEATHER CASE FOR iPad3****CARBON PATTERN**

360 degree rotatable textured leather case constructed from smooth, treated Leather that resists dirt and stains. Provides easy access to all functions without removing the case.

Colour	Code
White	CAS9060-351
Red	CAS9060-353
Blue	CAS9060-360
Pink	CAS9060-367

**360° ROTATABLE FLIP PU LEATHER CASE FOR iPad2, iPad3****PU LEATHER**

360 degree rotatable PU leather case with holder. Constructed from smooth, treated Leather that resists dirt and stains. Provides easy access to all functions without removing the case.

Colour	Code
White	CAS9060-151
Black	CAS9060-152
Red	CAS9060-153
Coffee	CAS9060-154
Blue	CAS9060-155
Green	CAS9060-156
Pink	CAS9060-157
Purple	CAS9060-158

**360° ROTATABLE CROCODILE SKIN FLIP LEATHER CASE FOR iPad3****ULTRA LOW PROFILE**

360 Degree rotatable & holder function crocodile texture leather case. Slim folio leather design. Leather exterior and injection-molded interior. Easy access to all ports and connectors. Built-in magnets draw the Smart Cover to iPad for a perfect fit.

Colour	Code
Burgundy	CAS9060-609





**DOT PATTERN FLIP LEATHER CASE WITH HOLDER FOR iPad3**

**360° ROTATABLE**

Maximum protection with innovative design and ergonomic consideration. Shock proof & anti-scratching material. Easy access to all ports and connectors.

Colour	Code
Black/Grey	CAS9060-312
Red/White	CAS9060-313
White/Orange	CAS9060-314
Black/Orange	CAS9060-315



**DOT PATTERN LEATHER SMART CASE FOR iPad, iPad3**

**INNOVATIVE DESIGN**

Maximum protection with innovative design and ergonomic consideration. Shock proof & anti-scratching material. Easy access to all ports and connectors.

Colour	Code
White/Blue	CAS9060-381
White/Black	CAS9060-382
Red/White	CAS9060-383
Blue/White	CAS9060-385
Black/White	CAS9060-392



**GENUINE LEATHER FLIP CASE WITH HOLDER FOR iPad3**

**ORIGINAL STYLE**

Keep your iPad safe and protected in style with this Leather case. Slip in your iPad to add a splash of color. Anti-dust, Impact protective and tear-resistant material. Constructed from smooth, treated Leather that resists dirt and stains.

Colour	Code
Black	CAS9060-322
Red	CAS9060-323
Yellow	CAS9060-324
Pink	CAS9060-327



**FLIP LEATHER CASE WITH HOLDER FOR iPad3**

**INNOVATIVE DESIGN**

Constructed from smooth, treated Leather that resists dirt and stains. Provides easy access to all functions without removing the case.

Colour	Code
Brown	CAS9060-102
Orange	CAS9060-104
Green	CAS9060-106
Purple	CAS9060-108
Maroon	CAS9060-109
Blue	CAS9060-110



SUPPLEMENT - NEW PRODUCTS

**ULTRA THIN PREMIUM LEATHER CASE FOR iPad3****FROSTED LEATHER**

Full housing ultra thin leather protector case with Sleep / Wake-up function. Treated Material with Anti-dust, Impact proof and tear-resistant protection.

Colour	Code
White	CAS9060-291
Grey	CAS9060-292

**DOUBLE FOLDED LEATHER CASE FOR iPad3****WITH HOLDER**

Two Fold, Top quality and durable Leather material. Precision molded case, perfectly fit to iPad. Covers the entire unit to prevent scratches and bumps.

Colour	Code
Black	CAS9060-122

**CHECKERED STYLE LEATHER CASE WITH HOLDER FOR iPad2, iPad3****HIGH QUALITY LEATHER**

Easy snap-on installation allows for quick usage. Protect your iPad from scratches, dust, shock and fingerprint.

Colour	Code
Black	CAS9060-502
Brown	CAS9060-504
Green	CAS9060-506

**SLEEP / WAKE-UP FUNCTION FLIP LEATHER CASE FOR iPad3****WITH HOLDER**

Safe and protected in style leather case with built-in magnets to draw the Smart Cover to iPad for a perfect fit that not only protects, but also wakes up, stands up, and brightens up your iPad. Easy access to all ports and connectors.

Colour	Code
Red	CAS9060-103
Blue	CAS9060-105
White	CAS9060-111
Black	CAS9060-112

**360° ROTATABLE LEATHER CASE WITH HOLDER FOR iPad3****LEATHER PROTECTION**

360 Degree Rotatable innovative design. Provides easy access to all functions without removing the case.

Colour	Code
Grey	CAS9060-162
Black	CAS9060-352





**JELLY SILICONE CASE FOR iPad3**

**TREATED SILICON**

Keep your iPad safe and protected in style with a coloured silicone case. Constructed from smooth and treated silicone to resist dirt and stains. Provides easy access to all functions without removing the case. Perfect fit and easy wash.

Colour	Code
Black	SCC9060BK
White	SCC9060WH
Red	SCC9060RD
Purple	SCC9060PU
Pink	SCC9060PK
Blue	SCC9060BL



**SLIM JELLY SILICON CASE FOR iPad3**

**WITH HOME BUTTON**

Keep your iPad safe and protected in style with a coloured silicone case. Constructed from smooth and treated silicone to resist dirt and stains. Provides easy access to all functions without removing the case. Perfect fit and easy to wash.

Colour	Code
Red	SCC9060-103
Orange	SCC9060-104
Green	SCC9060-106
Pink	SCC9060-107
Purple	SCC9060-109
Blue	SCC9060-110
Black	SCC9060-112
Yellow	SCC9060-113



**JELLY TPU CASE FOR iPad3**

**SAFE & CHARMING**

TPU jelly cases provides protection and durability. Long lasting slim, light, fashionable and charming cases. Constructed from smooth, treated material that resists dirt & stains.

Colour	Code
Clear	TPU9060-201
Ash	TPU9060-202
Red	TPU9060-203
Orange	TPU9060-204
Green	TPU9060-206
Pink	TPU9060-207
Blue	TPU9060-210
White	TPU9060-211
Black	TPU9060-212



**BUBBLE TEXTURED JELLY TPU CASE FOR iPad2, iPad3**

**SUPER PROTECTION**

TPU jelly cases provides protection and durability. Long lasting slim, light, fashionable and charming cases. Constructed from smooth, treated material that resists dirt & stains.

Colour	Code
Clear	TPU9060-301
Ash	TPU9060-302
Red	TPU9060-303
Blue	TPU9060-310





**LATTICE JELLY TPU CASES FOR iPad3****FASHIONABLE AND CHARMING**

TPU jelly cases provides protection and durability. Long lasting slim, light, fashionable and charming cases. Constructed from smooth, treated material that resists dirt & stains.

Colour	Code
Clear	TPU9060-101
Ash	TPU9060-102
Red	TPU9060-103
Blue	TPU9060-105
Purple	TPU9060-108
Magenta	TPU9060-109

**RAINDROP JELLY TPU CASE FOR iPad3****ULTRA SLIM**

TPU jelly cases provides protection and durability. Long lasting slim, light, fashionable and charming cases. Constructed from smooth, treated material that resists dirt & stains.

Colour	Code
Clear	TPU9060-251
Ash	TPU9060-252
Red	TPU9060-253
Blue	TPU9060-255
Purple	TPU9060-258
Pink	TPU9060-257

**SMART COVER HARD PLASTIC CASE FOR iPad3****FULL BACK PROTECTION**

Back plastic case protects your iPad from scratches and damage. Ultra-Slim and light weight made of durable and flexible material. Unique design and perfect fit. Easy access to all ports and connectors.

Colour	Code
Red	BPC9060-303
Blue	BPC9060-305
Pink	BPC9060-307
Yellow	BPC9060-313
Grey	BPC9060-322
White	BPC9060-321
Black	BPC9060-332
Silver	BPC9060-331

**ONE PIECE BPC PLASTIC CASE FOR iPad3****ULTRA SLIM**

Back plastic case protect your iPad from scratches and damage. Ultra-Slim and light weight made of durable and flexible material. Unique design and perfect fit. Easy access to all ports and connectors.

Colour	Code
Clear	BPC9060-301
White	BPC9060-311
Black	BPC9060-312



**SLIP IN LEATHER CASES FOR iPad, iPad2, iPad3**

**REVERSIBLE NEOPRENE**

Micro fiber leather case provides cushioning to your iPad. Protection against dust & scratches. Reversible case allows you to choose the colour fits your mood.

Colour	Code
Black	POU9060-592
Magenta	POU9060-599



**SOFT SLIP IN SLEEVE CASE FOR iPad, iPad2, iPad3**

**JEANS STYLE**

Provides cushioning for your iPad and protect it from dust and scratches. Easy to insert and remove.

Code
POU9060-120



**ZIPPER SLEEVE CASES FOR iPad, iPad2, iPad3**

Cushion your iPad and protect it from dust and scratches. Super soft, light weight and durable. Made of high quality neoprene material. Reversible case allows you to choose the color fits your mood/ outfit.

Code	Colour
POU9030-512	Black



**ZIPPER LEATHER CASE FOR iPad, iPad2, iPad3**

Zipper Leather Wallet Pouch With Card Pockets & Magnetic handles.

Colour	Code
Black	POU9030-114



**iPAD VELVET SLIP IN POUCH FOR iPad, iPad2, iPad3**

Velvet feel soft pouch. Protect your iPad from minor scratches and light bumps.

Colour	Code
Cream	POU9030-131
Black	POU9030-132
Grey	POU9030-133



**iPAD SOCKS CASES FOR iPad, iPad2, iPad3**

Keep your iPad safe & snug with this fashionable colourful range of socks. Custom made for perfect fit.

Colour	Code
Black	SOC9030BK
Green	SOC9030GN
Orange	SOC9030OR
Purple	SOC9030PU
Pink	SOC9030PK
Grey	SOC9030GY



**WATERPROOF BAG FOR iPad, iPad2, iPad3**

**QUAD SEALING**

High quality waterproof bag with a lanyard for easy carrying . New generation which have many features including waterproof, dustproof, Sand & Snow proof. Inbuilt waterproof stereo socket to connect the earphones. Supplied with a stereo earphones. Suitable for outdoor, beach, swimming pool, and under water outdoor activities. Size 290x210mm.

Colour	Code
Yellow	POU9060-993



**UNIVERSAL USB SOLAR CHARGER****POLYMER LITHIUM-ION BATTERY**

USB Solar Charger with multiple Adapters to suit most devices such as iPhone/iPod, MP3 Players, Mobile Phones, GPS, cameras, etc. Includes 5 adaptors (mini usb, micro usb, apple, nokia, Sony Ericsson) and USB lead. 5.5V

Capacity	Output	Size	Code
1300mAh	5.5VDC-750mA	99x55x15mm	SC10
3500mAh	5.5VDC-750mA	99x55x15mm	SC20

**MULTI-FUNCTION CHARGING STAND FOR iPad, iPad2, iPad3**

Multi-function stand which will charge and also allow you to operate your iPad at the same time, perfect for watching your favourite movie while charging. Very stable with adjustable base, compatible with iPad 1, 2 and 3.

Code  
DCT9040

**iDOC STATION FOR iPad, iPad2, iPad3**

Synchronize your iPad with this docking / cradle to PC. The USB docking cradle holds your iPad at a comfortable reading angle and provides convenient access on your desk.

Colour Code  
Black MDC9030

**PORTABLE VIDEO STANDS FOR iPad, iPad2, iPad3**

Prevents cervical vertebra and back fatigue. Adjustable height elevates screen to comfortable viewing position. Enhances airflow around your iPad, keeping it cool. Extremely portable, it collapses to fit in your pocket or your bag. 360 swivel, share your screen in meeting.

Code  
STN9030

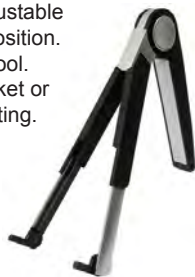
**ALUMINIUM STAND HOLDER FOR iPad, iPad2, iPad3**

Specially designed for iPad. Resists dirt, stains and is anti-static and anti-slip, protect your iPad from dirt, scratch, etc. All interface, ports and buttons available for direct use. 360 degrees rotatable, hold iPad in either horizontal or vertical position freely.

Code  
STN9031

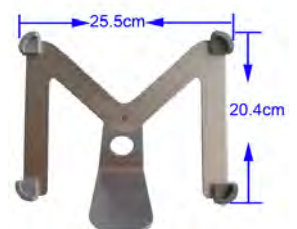
**UNIVERSAL CRADLE HOLDER**

Compact and lightweight design Extra-firm gooseneck absorbs vibration, providing a stable viewing environment. The flexible arm can be adjusted to any angle for easy viewing.

Size Code  
Max=300mm min=200mm CRA57

**WINDSCREEN MOUNT CRADLE HOLDER**

Compact and lightweight design Extra-firm gooseneck absorbs vibration, providing a stable viewing environment. The flexible arm can be adjusted to any angle for easy viewing. 360° Swivel Clip.

Code  
CRA9040





## 19" SMART RACK FULL HEIGHT SERVER CABINETS

### STEEL MESH DOOR

A server rack which offers advanced features and functionality for data centre applications where robust, 19 inch rack infrastructure is a required. Innovative features include cable zones and inset posts, giving additional space around the rack for easy cable access. Removable sides with locks. Mesh & back barn doors to maximise the cooling. Sliding & fixed shelf (2 with 48U).

### FLAT PACK CABINETS

Rack	Outer Dimensions	Code
25U	620x1100x1350	RC625
48U	620x1100x2240	RC648

#### \*Prices are for pick up only

Transportable packaging. Delivery service of flat packs is available Australia wide at additional cost, due to size and weight. Cost will vary depending on delivery location. Requires assembly. Instructions included. Please contact us .

### ASSEMBLED CABINETS

Rack	Outer Dimensions	Code
25U	620x1100x1350	RC625ASY
48U	620x1100x2240	RC648ASY

#### \*Prices are for pick up only

Delivery service of assembled cabinets is available within the Sydney Metro Area only, at additional cost, depending on delivery location. Please contact us.



## 19" FULL HEIGHT SERVER CABINETS

### PERFORATED STEEL

A server rack which offers advanced features and functionality for data centre applications where robust, 19 inch rack infrastructure is a required. Innovative features include cable zones and inset posts, giving additional space around the rack for easy cable access. Removable sides with locks. Front & back steel mesh doors to maximise the cooling. Sliding & fixed shelf (1 with 22U & 3 with 47U).

### FLAT PACK CABINETS

Rack	Outer Dimensions	Code
22U	620x1100x1170mm	RC622
47U	620x1100x2270mm	RC647

#### \*Prices are for pick up only

Transportable packaging. Delivery service of flat packs is available Australia wide at additional cost, due to size and weight. Cost will vary depending on delivery location. Requires assembly. Instructions included. Please contact us .

### ASSEMBLED CABINETS

Rack	Outer Dimensions	Code
22U	620x1100x1170mm	RC622ASY
47U	620x1100x2270mm	RC647ASY

#### \*Prices are for pick up only

Delivery service of assembled cabinets is available within the Sydney Metro Area only, at additional cost, depending on delivery location. Please contact us.



## 19" DATA CABINETS

### SOLID STEEL

A server rack which offers advanced features and functionality for data centre applications where robust, 19 inch rack infrastructure is a requirement. Innovative features include cable zones and inset posts, giving additional space around the rack for easy cable access. Supplied with lockable wheels & fixed shelves. 1 fixed shelf for 18U & 22U, 2 fixed shelves for 32U. The 42U is supplied with 3 fixed shelves, a 6 way Power Board, adjustable feet and castor kit.

### FLAT PACK CABINETS

Rack	Outer Dimensions	Code
12U	600x450x635mm	PU-RWC12-450
12U	600x600x635mm	PU-RWC12-600
15U	600x450x770mm	PU-RWC15-450
15U	600x600x770mm	PU-RWC15-600
18U	600x450x990mm	PU-RWC18-450
18U	600x600x990mm	RC186U
18U	600x800x990mm	RC188U
22U	600x600x1200mm	RC226U
22U	600x800x1200mm	RC228U
32U	600x600x1600mm	RC326U
32U	600x800x1600mm	RC328U
42U	600x600x2000mm	RC426U
42U	600x800x2000mm	RC428U
42U	600x1000x2000mm	RC421U

### \*Prices are for pick up only

Transportable packaging. Delivery service of flat packs is available Australia wide at additional cost, due to size and weight. Cost will vary depending on delivery location. Requires assembly. Instructions included. Please contact us .



For illustration purpose only

### ASSEMBLED CABINETS

Rack	Outer Dimensions	Code
12U	600x450x635mm	PU-RWC124ASY
12U	600x600x635mm	PU-RWC126ASY
15U	600x450x770mm	PU-RWC154ASY
15U	600x600x770mm	PU-RWC156ASY
18U	600x450x990mm	PU-RWC184ASY
18U	600x600x990mm	RC186ASY
18U	600x800x990mm	RC188ASY
22U	600x600x1200mm	RC226ASY
22U	600x800x1200mm	RC228ASY
32U	600x600x1600mm	RC326ASY
32U	600x800x1600mm	RC328ASY
42U	600x600x2000mm	RC426ASY
42U	600x800x2000mm	RC428ASY
42U	600x1000x2000mm	RC421ASY

### \*Prices are for pick up only

Delivery service of assembled cabinets is available within the Sydney Metro Area only, at additional cost, depending on delivery location. Please contact us.



For illustration purpose only

## 800mm WIDE FULL HEIGHT DATA CABINET

### 4 LARGE CABLE MANAGER

Solid steel, finished in a neutral colour, with tempered smoked glass front door and comes complete with all the basic accessories you need to get up and going. Standard features and accessories include, 3 fixed shelves, a roof mounted fan tray, a 6 way Power Distribution Unit (PDU), adjustable feet and castor kit.

### FLAT PACK CABINETS

Rack	Outer Dimensions	Code
42U	800x800x2000mm	RC842

### \*Prices are for pick up only

Transportable packaging. Delivery service of flat packs is available Australia wide at additional cost, due to size and weight. Cost will vary depending on delivery location. Requires assembly. Instructions included. Please contact us .

### ASSEMBLED CABINETS

Rack	Outer Dimensions	Code
42U	800x800x2000mm	RC842ASY

### \*Prices are for pick up only

Delivery service of assembled cabinets is available within the Sydney Metro Area only, at additional cost, depending on delivery location. Please contact us.



## WALL MOUNT / FLOOR COMPACT CABINETS

### 19" RACK UNITS

Professional design & manufacture. Full enclosure secures IT equipment. All metal bolt-together construction. Attractive black powder coat finish. Ventilation and cable access ports. Optional fan locations (extra). Hinged lockable door with glass. Removable side access panels. Removable back access panel. 12U, 15U & 18U versions lockable wheels.

### FLAT PACK CABINETS

Transportable packaging. Courier by road transport Australia wide. Requires assembly. Instructions included.

Rack	Outer Dimensions	Code
4U	600x450x330mm	PU-RWC4-450
6U	600x450x370mm	PU-RWC6-450
6U	600x600x370mm	PU-RWC6-600
12U	600x450x635mm	PU-RWC12-450
12U	600x600x635mm	PU-RWC12-600
15U	600x450x770mm	PU-RWC15-450
15U	600x600x770mm	PU-RWC15-600
18U	600x450x990mm	PU-RWC18-450

### ASSEMBLED CABINETS

Rack	Outer Dimensions	Code
4U	600x450x330mm	PU-RWC44ASY
6U	600x450x370mm	PU-RWC64ASY
6U	600x600x370mm	PU-RWC66ASY
12U	600x450x635mm	PU-RWC124ASY
12U	600x600x635mm	PU-RWC126ASY
15U	600x450x770mm	PU-RWC154ASY
15U	600x600x770mm	PU-RWC156ASY
18U	600x450x990mm	PU-RWC184ASY

Delivery service of assembled cabinets is available within the Sydney Metro Area only, at additional cost, depending on delivery location. Please contact us.



REMOVABLE SIDE ACCESS PANELS

## WALL MOUNT SWING CABINETS

### 19" RACK HINGED BACK

Heavy duty wall frame with cable ports. Designed to be wall mounted with back hinge to swing the entire cabinet open for easier rear of unit item access. Professional design & manufacture. Full enclosure secures IT equipment. All metal bolt-together construction. Full adjustable internal mountings. Ventilation and cable access ports. Optional fan locations (extra). Hinged lockable door with glass. Removable side access panels. All internal are adjustable.

### SUPPLIED ASSEMBLED

Rack	Outer Dimensions	Code
6U	600x450x370mm	PU-ROC6U
12U	600x450x635mm	PU-ROC12U
15U	600x450x770mm	PU-ROC15U

### \*Prices are for pick up only

Delivery service of assembled cabinets is available within the Sydney Metro Area only, at additional cost, depending on delivery location. Please contact us.

### INTERNAL SHELVING OPTIONAL [SUIT ROC & RWC Series]

Type	Size	Code
Fixed	490x270mm	SHF107
Slide	490x270mm	SHF108



## PATCH PANEL WALL MOUNT

### AMDEX PANELS

Snap-In Bracket for rear access. Above wall mount Front 12x RJ45. Rear punch-down 110 Tool type. Krone® compatible.

### CAT6 x12

Code  
DA623

### CAT5e x12

Code  
DA201



## CAGED NUTS

### SET OF FOUR

Black screw cross-head Plastic washer Caged Nut Suit racks. Order one to receive a bag of 4 sets:

Code  
CNM601



## CEILING EXTRACTORS

### SUIT RC SERIES RACKS

Cast frame long life fans. Mounts to roof of cabinets. Suits Floor standing servers. Includes 240Vac powerpack.

### TWO FANS 600mm

Size Code  
350x420x40mm RFK101

### FOUR FANS 800mm

Size Code  
550x420x40mm RFK103



## VENTILATION FAN KIT

Cast frame 120x38mm Direct to cabinet mounting solution Fit roofs or walls Suits rack cabinets Long life bearings 12Vdc low-noise fans Includes power pack Includes finger guards Includes two fans.

Code  
RFK105





**19" WALL BRACKET****HINGED WALL MOUNT**

Stand-alone bracket for wall mounting 19" rack item/s with hinged side allows direct access to rear for cabling, etc. Depth 195mm(max.).

**2U**

Code  
RWB2U

**4U**

Code  
RWB4U

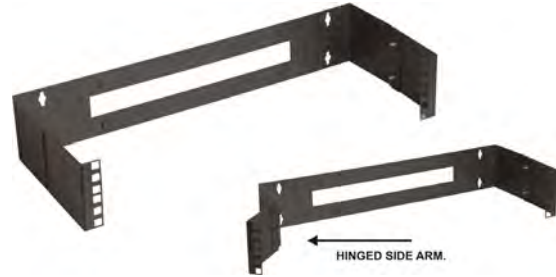
**19" FIXED SHELF**

Solid fixed shelf Metal construction Ventilation slots Black. Two depths:

**FIT CABINETS**

Size	Code
470x350mm	SHF101
470x550mm	SHF103
490x270mm	SHF107

**19" SLIDE SHELF**

Nylon wheel slide Metal construction Ventilation slots Black. Two depths:

**FIT CABINETS**

Size	Code
470x350mm	SHF105
470x550mm	SHF106
490x270mm	SHF108

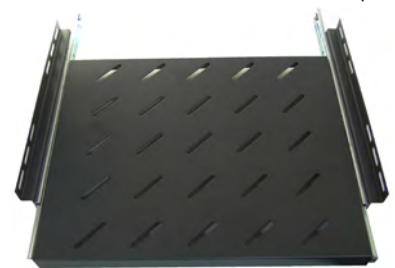
**19" BLANKING PANELS**

Fill up unused RU's Rack Units in your server racks with these 19" Rack Mounted Blanking Panels. Protect equipment from dust. Makes cabinet look complete.

**1U PLASTIC**

Easy clip-in snap-lock design.

Rack	Code
1U	BP1RU

**2U METAL**

Powder coated steel panel. Requires mounting screws.

Rack	Code
2RU	BP2RU

**3U METAL**

Powder coated steel panel. Requires mounting screws.

Rack	Code
3RU	BP3RU

**UNEQUIPPED 19" 1U PANELS****AMDEX HEXAGONAL PANELS**

Mounting solution supplied empty Metal Panel Numbered & Labelled 16 HEX shaped holes requires sockets.

Hole	Code
16x 9.5mm	CMR107

**AMDEX KEYSTONE PANELS**

Mounting solution supplied empty 16 holes requires "Keystone" sockets.

Code
CMR110

**CAT5e EQUIPPED 19"****PATCH PANEL**

Front RJ45 Sockets Numbered & Labelled Rear single appearance Punch 110 Tool type Krone® compatible Includes screws.

**CAT 5e PATCH PANEL**

Type	Height	Code
24 Way	1U	CAT5R101
48 Way	1U	CAT5R103

**CAT 6 PATCH PANEL**

Type	Height	Code
24 Way	1U	CAT6R201
48 Way	2U	CAT6R202
48 Way	1U	CAT6R203

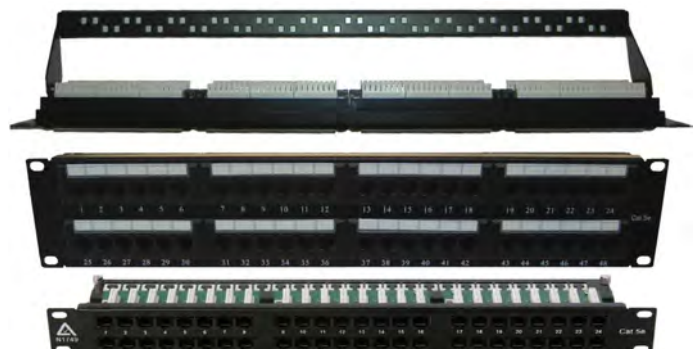

**CABLE MANAGER 19"**

**METAL FINGERS OPEN TYPE**

Five "C" clips to hold and organise network cables. Neat and tidy Metal fascia Includes screws.

Suit	Rack	Code
19"	1U	CMR101



**PLASTIC FINGERS  
REDUCE CABLE MESS 19"**

Suits	Rack	Code
19"	1U	GEPM03

**CABLE MANAGER 19"**

**CLOSED TYPE**

Behind fascia type hold and organise network cables. Neat and tidy Plastic models Includes screws.

Suit	Rack	Code
19"	1U	CMR103
19"	2U	CMR102



**SIDE-RACK CABLE MANAGER**

**"T" FINGER ORGANISER**

Mounts directly to the vertical rail of an industry standard rack system 7x "T" Fingers at RMU intervals 305mm long UL94V-0 plastic

Code
CMR105

**HINGE TYPE**

Allows the addition of a door panel\* (\*not included) to cover cables, etc

Code
CMR106



**19" RACK MOUNT POWER BOARD**

**SPIKE & 10A PROTECTED**

Illuminated power switch. 10A Resettable fuse button. Single MOV Spike arrester and 1 Metre Cord R/A Plug.

Type	Code
6 Outlet	PB60RK



**19" RACK MOUNT POWER BOARD**

**SPIKES AND 10A PROTECTED**

High quality metal cased 1U & 2U rack mounted powerboards. Ideal for server rooms and audio installations. 1575 joules spike surge and 10A overload protected. EMI & RFI Filtering. Power ON and earth LED indicators. IEC socket with 1.8M Power lead.

Type	Code
6 Outlet	RAC0600
12 Outlet	RAC1200



**19" COMMERCIAL GRADE POWER RAILS**

Supplied with 2 Cage Nut Screw Sets. 10A Resettable Fuse. Led Power Indicator. 2.8M power cord. PR8H Horizontal style suits the required length for rack mounting (19") and is recessed for plug space. Vertical style has the mounting brackets towards the back for affixing to the cabinet sides or back, etc. 65(w) x 45(h) mm x Length + Flange.

**Horizontal Mounting**

Type	Length	Code
8 Outlet	430mm	PR8H

**Vertical Mounting**

Type	Length	Code
10 Outlet	500mm	PR10V
15 Outlet	720mm	PR15V
20 Outlet	950mm	PR20V



**19" RACK MOUNTED POWER BOARDS**

**ALUMINIUM CASING 1.5RU**

Illuminated master power switch with protective cover. 1.5RU a little more space. 6way has adaptor spacing. Aluminium-alloy casing. 10A Resettable fuse button. Single MOV Spike arrester surge protection. Rated to maximum output power 2400W. Black 430mm long. 2M cord. Australian Approved SAA100425EA

Type	Rack	Code
6 Outlets	1.5 RU	PDU600
8 Outlets	1.5 RU	PDU800



**19" VERTICAL POWER RAIL 15 WAY**

**ALUMINIUM CASING 1RU**

Illuminated master power switch with protective cover. 1RU. Outlets grouped with spacing for adaptors, etc. Aluminium-alloy casing. 15A Resettable fuse button. Single MOV Spike arrester surge protection. Rated to maximum output power 3600W. 880mm long. 2M cord. Oversized 15A Plug. Australian Approved SAA100425EA

Type	Rack	Code
15 outlets	1 RU	PDU1500



15A MAINS PLUG

**10" CABINET RACK****MINI PROFESSIONAL**

Small-Office/Home-Office Store & organise networking products and cables in an all-metal pro enclosure.  
Offers Ample ventilation Sturdy metal construction  
Glass door for easy view door key-locked security  
Neat and tidy solution Assorted access holes Black anodised painted Reduces noise & clutter

Rack	Size	Code
6 Units	285Wx200Dx330H	DACAB6RU
9 Units	285Wx200Dx460H	DACAB9RU

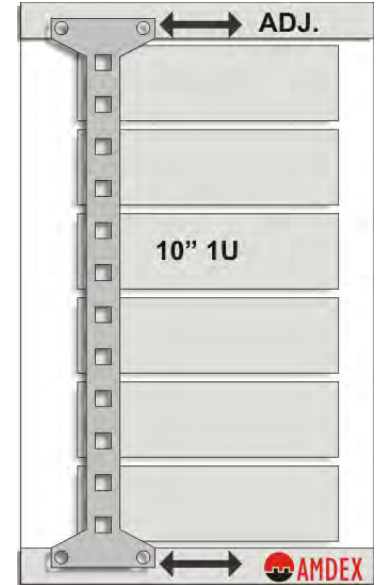
**10" CABLE MANAGER**

Three "C" clips to hold and organise cable entry/exit. Neat and tidy with front fascia cover. Includes screws

Mount	235-240mm
Size	255x44x80mm
Suit	10"
Rack	1U
Code	DA10-207

**10" SHELF****AMDEX PANELS**

1U support shelf

Depth	135mm
Code	DA10-SHELF



STOCK MAY VARY FROM ILLUSTRATION

**10" VOICE PANEL**

AMDEX® 10" Panel 2x10 Pair Disconnect Modules (Push-Down Type)

Code	DA10-20P
------	----------

**10" VOICE PANEL**

Connect single input to 4 Exchange lines with 6 extensions per line (4x6) Punch 110 Tool type Krone® compatible inline DIP switch Optional front entry Rear cable organiser.

Code	DA10-VC
------	---------

**10" BLANK****AMDEX PANELS**

Amdex is a leader in professional IT 3rd party tested to industry specifications. 1U Metal Blank Panel. Includes mount screws.

Mount	235-240mm
Size	255x44mm
Suit	10"
Rack	1U
Code	DA10-BLANK

**10" UNEQUIPPED HEXAGONAL**

Mounting solution. Requires Sockets. Supplied empty. Metal Panel with 10 HEX shaped holes. Numbered & Labelled. Rack screws inc.

Hole	10x 9.5mmØ
Suit	10"
Rack	1U
Code	DA10-HEX

**10' UNEQUIPPED KEYSTONE**

Socket Mounting solution. Requires Keystone pieces supplied separately. Metal Panel w/ 8 holes 16x14mm Keystone clips Numbered & Labelled. Includes rack screws.

Suits	10"
Rack	1U
Code	DA10-BEZ

**10" CAT5e EQUIPPED****AMDEX PANELS**

Front RJ45 Sockets Numbered & Labelled Rear single appearance Punch 110 Tool type Krone® compatible Includes screws

**8 WAY**

Code	DA10-8P-C5E
------	-------------

**12 WAY**

Code	DA10-12P-C5E
------	--------------

**10" CAT6 EQUIPPED****8 WAY**

Code	DA10-8P-C6
------	------------

**12 WAY**

Code	DA10-12P-C6
------	-------------





**115mm FLUSH CUTTING PLIER**

**SK-5 STEEL MATERIAL**

High quality SK-5 steel material with 50HRC blade hardness. Ø0.6mm soft wire & Ø1.0mm copper wire cutting capability. Excellent edge sharpness and Comfortable PVC grip reduces the operator's fatigue and increases productivity. Compact and easy to handle. Light weight only 50g. High frequency wave heat treatment for blades, No acidification treatment. Suitable for cutting wire, protruding lead, plastic flash, thin metal wire. Applicable for repair work of electronics industry, jewelry processing, modeling, ect.

Code  
MN-1702



**115mm FLUSH CUTTING PLIER**

**SK-5 STEEL MATERIAL**

High quality SK-5 steel material with 50HRC blade hardness. Ø0.6mm soft wire & Ø1.0mm copper wire cutting capability. Excellent edge sharpness and Comfortable PVC grip reduces the operator's fatigue and increases productivity. Compact and easy to handle. Light weight only 50g. High frequency wave heat treatment for blades, No acidification treatment. Suitable for cutting wire, protruding lead, plastic flash, thin metal wire. Applicable for repair work of electronics industry, jewelry processing, modeling, ect.

Code  
MN-170



**125mm DIAGONAL CUTTING PLIER**

**CRV MATERIAL**

High quality CRV material, which is strong and durable. Ø1.8mm soft wire and Ø2.6mm copper wire cutting capacity. Cutting blades are high frequency induction heated, which ensures good cutting ability and longer life. Japan style anti-slip grip, comfortable and with good insulation. Glare-eliminating black finish on the head part; having a superior grade appearance. Suitable for electrical repair work, vehicle maintenance, and household work, etc. Specially designed to cut thin lead and components lead. Excellent cutting with sharper edges. Longer service life. Double Cutting Edges Design prevents overlapping in cutting.

Code  
XK-125J



**150mm DIAGONAL CUTTING PLIER**

**HEAVY DUTY**

High quality CRV material, which is strong and durable. Ø2.0mm soft wire and Ø3.2mm copper wire cutting capacity. Cutting blades are high frequency induction heated, which ensures good cutting ability and longer life. Japan style anti-slip grip, comfortable and with good insulation. Glare-eliminating black finish on the head part; having a superior grade appearance. Suitable for electrical repair work, vehicle maintenance, and household work, etc. Specially designed to cut thin lead and components lead. Excellent cutting with sharper edges. Longer service life. Double Cutting Edges Design prevents overlapping in cutting.

Code  
SK-150



**125mm LONG NOSE PLIER**

**S55C MATERIAL**

Superior quality high-carbon steel (S55C) material with Ø1.0mm hard wire and Ø1.8mm soft wire cutting capacity. High frequency wave heat treatment. PVC grip for maximum comfort. Mainly used for cutting slim solid wire and strand wire, stripping plastic insulating, etc. It can also be used for pinching minor screw caps, twisting hard steel wire, cutting lead with its tips, etc. It is widely used in assembly and repair work for instruments and telecommunication appliances. It is also a common tool for electricians.

Code  
ZJ-125



**150mm LONG NOSE PLIER**

**HIGH CARBON STEEL**

Superior quality high-carbon steel (S55C) material with Ø1.2mm hard wire and Ø2.0mm soft wire cutting capacity. High frequency wave heat treatment. PVC grip for maximum comfort. Mainly used for cutting slim solid wire and strand wire, stripping plastic insulating, etc. It can also be used for pinching minor screw caps, twisting hard steel wire, cutting lead with its tips, etc. It is widely used in assembly and repair work for instruments and telecommunication appliances. It is also a common tool for electricians.

Code  
ZJ-316



SUPPLEMENT - NEW PRODUCTS

## ESD GROUNDING SOCKETS

### ESD CONTROL

ESD grounding socket with easy mounting. Two button fastener and two 4mm banana sockets.

Code  
ELET-601



## ELASTIC ESD WRIST BAND

### SOFT CLOTH TYPE

Fully adjustable with extra operator comfort. Made up of super conductive fiber. Conductive metal threads provides maximum skin contact. Built in protective 1MΩ resistor and press stud. Includes a 3M coil cord terminates to a banana plug with alligator clip. Connects to ESD mats or chassis, etc

Code  
ASW116



## VELCRO ESD WRIST BAND

Fully adjustable with extra operator comfort. Conductive metal threads provides maximum skin contact. Built in protective 1MΩ resistor and press stud. Includes a 3M coil cord terminates to a banana plug with alligator clip. Connects to ESD mats or chassis, etc

Code  
ASW117



## ESD GROUNDING CORD

Grounding cord for ESD mats and wrist bands. 10mm moulded metal stud with Easy mount metal claw. 2M cord with banana and alligator clip. Built in 1MΩ provides safe and reliable ground for personnel at work.

Code  
ELET-606



## COMMON GROUND CORD

Benchtop ESD mat solution. 10mm female snap for stud with metal claw mount. 2M long. Built-in 1MΩ. Accepts 2x 4mm banana. Ring Lug at the other end for easy attachment to ESD ground

Code  
ELET-608



## PINK ESD DISPENSER

Designed to be used with evaporative or dangerous fluids. Simply push down & a measured amount is transferred to the top to use as required. Made of high density polyethylene and is suitable for alcohol, ether, acetone, M.E.K, polish remover, flux remover, stripper, thinner, etc., etc. Stable. Sturdy. Available as standard cap or with locking cap for easy transportation. Consists of hinged lid to keep out from impurities.

Size Code  
120ml IPA-120  
180ml IPA-180



## ANTISTATIC BRUSHES

### CONDUCTIVE FIBER

Synthetic bristles and conductive black fibers. Dissipative polypropylene black handles are able to remove charges to ground. Brushes minimize static charge generation and dissipate ESD charges to ground when held by grounded personnel. Remove dirt from PCB's or other sensitive components, and discharge static electricity. Heat Resistance up to 80°C. Mild Chemical and Acid Resistance. Handle surface resistivity 1MΩ-1GΩ (PP). Bristle surface resistivity 10MΩ-10GΩ (Nylon). Anti-static Nylon bristle with Ø 0.12mm. Wide range of applications in industries like Electronic, Glove, Food & Beverage, Wood, Textile etc.

### 17mm ESD BRUSH

Long Thick Bristles (Hard)

Size Code  
17mm ESD-B05



### 18mm ESD BRUSH

Short Thin Bristles (Soft)

Size Code  
18mm ESD-B04



### 32mm ESD BRUSH

Single bristle row

Size Code  
32mm ESD-B07



### 55mm ESD BRUSH

Single bristle row

Size Code  
55mm ESD-B09



### 32mm ESD BRUSH

10mm width with Triple bristle rows

Size Code  
10x32mm ESD-B01



### 60mm ESD BRUSH

12mm width with Triple bristle rows

Size Code  
12x60mm ESD-B02



### 65mm ESD BRUSH

32mm wide with five bristle rows

Size Code  
32x65mm ESD-B06



## STAINLESS STEEL PRECISION TWEEZERS

### SWISS QUALITY

Super fine high precision, High exactitude, Exceed hard, Anti - Magnetic, Anti - Acid, Non - Corrosive. HRC40 hardness. Premium grade. Long service life.

### 120mm FLAT TIP

Code  
TW-34SA



### 125mm SUPER FINE TIP STRAIGHT

Code  
TW-AASA



### 135mm SUPER FINE TIP STRAIGHT

Code  
TW-00SA



### 125mm SUPER FINE TIP STRAIGHT

Code  
TW-2SA



### 120mm SUPER FINE TIP STRAIGHT

Code  
TW-3SA



### 110mm SUPER FINE TIP STRAIGHT

Code  
TW-4SA



### 110mm SUPER FINE TIP STRAIGHT

Code  
TW-5SA



### 120mm SUPER FINE TIP CURVED

Code  
TW-7SA



### 140mm SUPER FINE TIP STRAIGHT

Code  
TW-SSSA



## 120mm FLAT & ROUND

Code  
TW-2ASA



## 110mm SUPER FINE TIP STRAIGHT

Code  
TW-3CSA



## STAINLESS STEEL TWEEZERS

### PRECISION TOOL

Selected professional tool. Surgical quality tools, Anti-acid, Anti-Magnetic, Non-Corrosive. Polished. Non-slip. Long Life. Won't distort. HRC40 hardness. Premium grade.

## 110mm FINE TIP STRAIGHT

Code  
TW-ST10



## 140mm FINE TIP STRAIGHT

Code  
TW-ST11



## 135mm FINE TIP STRAIGHT

Code  
TW-ST12



## 115mm FLAT & ROUND

Code  
TW-ST13



## 110mm SUPER FINE TIP STRAIGHT

Code  
TW-ST14



## 120mm FINE TIP CURVED

Code  
TW-ST15



SUPPLEMENT - NEW PRODUCTS



# Aerpro<sup>®</sup>

## First Choice

### FM MODULATOR WITH IPOD INTEGRATION AND VIDEO OUTPUT

## Model: AP7482

#### Specifications:

- iPod, input interface
- iPod, iPhone connection cable
- 2.1A AV Cable
- 3.5mm to 3.5mm audio cable
- 3.5mm to RCA adaptor (for other MP3 devices)
- 2 Selectable FM frequencies 88.1 - 88.3 Mhz

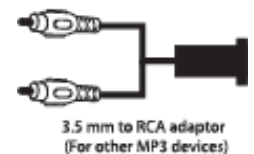
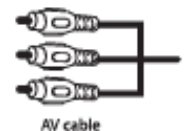
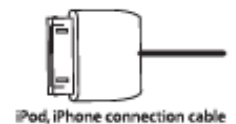
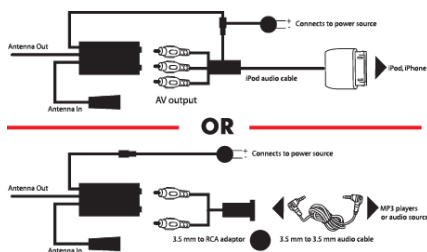

Play your iPod, iPhone, MP3 player or other portable media device through your factory or aftermarket FM car stereo system with this product.

**SUPER SMD LED**  **NEW** SMD LED Flat Lights now available

# SMD LED FLAT LIGHTS

Super bright, super durable flat type SMD LED available in both blue & white. Use for multiple applications for small areas, interior & exterior use as it's water resistant



Try Me!

SUPPLEMENT - NEW PRODUCTS



Model No: SMD4W



Model No: SMD4B

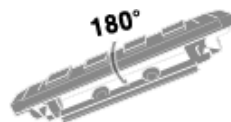

Base for set lighting angle

## FEATURES

Multi Applications:

- Interior & exterior use
- Courtesy door: Foot light
- License plate cover: License plate light
- Radiator grille: Daytime running light
- Trunk: Boot light
- Under dashboard: Interior light

Included with light:

- "Try me" push button on packaging
- Light x 2
- Adjustable base
- Double sided tape
- Cable connectors

## SPECIFICATIONS

- Water resistant
- Thickness 6mm flat design
- Cable length: 1m
- Unit dimensions: 6mm x 12mm x 70mm
- SMD LED 50/50 3 Chips
- Suitable for 12V installations only

**USB 2.0 FLASH DRIVE - TITAN****Hot Plug and Play**

Flash Drive has been designed for speed and long life. It features a smooth rubber coating, plastic body and a steel swivel lid. Don't worry about losing USB Flash Drive covers again! Supplied in poly bag.

Size	Code
4Gb	FDT4GB
8Gb	FDT8GB
16Gb	FDT16GB

**HDMI TO VGA CONVERTOR****WITH ANALOGUE 3.5mm AUDIO OUTPUT**

Flexible design & a line through function. Simply plug n play, no external power supply or driver required. HDMI Input. VGA output with a resolution up to 720p/1080i/1080p.

Code
CA415

**2.4GHz WIRELESS PRESENTER****Laser Pointer and Memory**

- • Trackball Resolution: Up to 400 Dpl.
- • Working Distance Up to 10 meters.
- • Laser pointer helps you highlight key points up to 200 M.
- • Plug and play simplicity requires no setup
- • Provides forward and back control of PowerPoint® and Keynote®
- • USB receiver
- • 2x AAA batteries (included)

Code
USB310



Receiver





## USB 3.0 SUPER SPEED CARD READER

### POCKET SIZE

USB 3.0 card reader supports memory cards - CF, M2, MS, SD, SDHC, SDXC, M2, XD, Micro SD, Micro SDHC, Micro SDXC & TF Card. Size 95x50x13mm.

Code  
USB3010



## USB 3.0 HUB 4 PORT

### HOT SWAPPABLE

High speed 4 port Hub with 4 USB 3.0 'A' port & 1 Micro USB 3.0 port. Suitable for U disk, card reader, USB mouse, USB keyboard, USB sound cards, scanners, digital cameras, hard drives and other equipment boxes.

Code  
USB3021



## USB 3.0 SUPER SPEED ALL IN 1 CARD READER

### ULTRA COMPACT SIZE

Supports memory cards: CF, M2, SD, SDHC, SDXC, M2, XD, Micro SD, Micro SDHC, Micro SDXC & TF Card. Size 62x62x25mm.

Code  
USB3011



## USB 3.0 HUB 4 PORT INTERNAL

3.5" internal 4 Ports USB 3.0 hub. Suitable for U disk, card reader, USB mouse, USB keyboard, USB sound cards, scanners, digital cameras, hard drives and other equipment boxes.

Code  
USB3022



## USB 3.0 INTERNAL CARD READER + HUB

### PLUG N PLAY

Supports memory cards: CF, M2, SD, SDHC, SDXC, M2, XD, Micro SD, Micro SDHC, Micro SDXC, MS & TF Card. High Speed USB 3.0 Ports. Fits to 3.5" slot. 20 pin connector that plugs directly into PC motherboard.

Code  
USB3012



## USB 3.0 HUB 4 PORT

### SUPER SPEED

Four ports USB 3.0, external equipment, plug and play, easy to use. Build-in current protection. USB power supply cable include for optional power. Size 60x60x20mm.

Code  
USB3023



## PCI-E 4 PORTS USB 3.0 HUB + CARD READER

### PCI-E CONNECTOR

USB 3.0 with high speed. 4 ports USB 3.0 HUB and 6 slots USB 2.0 card reader plug and play, easy and practical to use, Support SD / TF / XD / MS / M2 / CF Card. Standard 3.5 inch floppy size, easy to install. 4-pin molex socket for power supply to each USB 3.0 connector up to 900mA MAX. Build-in over current protection. USB 3.0, build-in PCI-E connector, final solution for upgrading PC to USB 3.0.

Code  
USB3030



## USB 3.0 HUB 4 PORT

High speed USB 3.0 HUB. Automatic switching between self powered and bus powered mode supports plug & play. Over-Current protection safety. Size 80x42.7x15mm.

Code  
USB3020



### 3 PORTS USB 3.0 HUB + CARD READER INTERNAL+ e SATA PORT

USB 3.0 Output Port with SD/TF/MS/M2 card reader. 3 USB port and 1 E-SATA port. Standard 3.5 inch floppy size, easy to install

Code  
USB3031



### 7 PORT USB 3.0 & USB 2.0 HUB

#### Powered Hub Manager

- 7 port powered USB hub manager
- Individual power switch to control on/off
- 4 of USB 3.0 super speed port up to 5Gbps
- 3 of USB2.0 port to connect common 2.0 device
- Support plug and play and hot swappable capability
- Big power pack to support multiple connections.
- Size 176x51.5x13mm.

Code  
USB3024



### USB 2.0 AUDIO CAPTURE

#### CAPTURE & EDIT AUDIO

Simple and fun way to convert audio from any source into digital storage like CD, MP3 or on hard disc. RCA L/R & 3.5mm jack for Audio Inputs to USB. Simply just plug to your USB port, record and play sounds. Edit your sounds using cut, copy, and paste features. Mix tracks, or apply effects to your recordings.

Code  
USB217



### USB 2.0 AUDIO 5.1CH

Complete USB2.0 Audio interface. 5.1 Channel 3.5mm (x3) Front, rear, centre/Sub output. SPDIF Toslink Optical output and input. 3.5mm Stereo Line in and microphone in. 16bit upto 48KHZ.

Code  
USB218





## USB 3.0 'A' FEMALE - 'B' MALE ADAPTOR

Code  
CA1050



## USB 3.0 'A' MALE TO 'A' FEMALE ADAPTOR

Code  
CA1056



## USB 3.0 'A' FEMALE - 'A' FEMALE ADAPTOR

Code  
CA1051



## USB 3.0 'A' MALE TO 'B' MALE ADAPTOR

Code  
CA1057



## USB 3.0 'A' FEMALE - MICRO 'B' MALE ADAPTOR

Code  
CA1052



## USB 3.0 'A' MALE TO MINI 10 PIN 'B' MALE ADAPTOR

Code  
CA1058



## USB 3.0 'B' FEMALE - MICRO 'B' MALE ADAPTOR

Code  
CA1053



## USB 3.0 'A' MALE TO MICRO 'B' MALE ADAPTOR

Code  
CA1059



## USB 3.0 'A' MALE TO 'A' MALE ADAPTOR

Code  
CA1054



## 2x USB 3.0 'A' MALE TO 20 PIN MOTHER BOARD ADAPTOR

Code  
CA1060

## USB 3.0 'A' MALE TO 'A' FEMALE ADAPTOR

Code  
CA1055





**ACCENTO 100V 4" CEILING SPEAKER ENCLOSED METAL BOX**

Designed for 100V PA applications. Compact 4" ceiling speaker within an enclosed metal housing. Easy and Quick install with spring loaded tabs. Fits in ø105mm mounting hole.

Input	100V
Taps	6W/3W/1.5W
Size	4"
Pmax	12W
Prms	6W
Freq.	86 +/- 2 dB
Sens.	130Hz - 20KHz
Dimensions	134x94mm
Code	ADS400C

**ACCENTO 5 1/4" 2-WAY 8 OHM RECTANGLE CEILING / IN-WALL**

Modern Micro Flange Style. High End Sound reproduction via twin Mid / Woofer configuration. 25mm Dynamic Silk Dome Neodymium Tweeter with two High Performance 5 1/4" Mid-Woofers, perfectly matched crossover using high quality components maintains signal clarity and definition. Ideal for home theatre applications for use as front stage Left / Centre / Right using an In-Wall configuration. Also suits high end multi-room audio applications.

Input	8 Ohm
Pmax	80W
Prms	40W
Freq.	62Hz - 20KHz
Sens.	86 +/- 2 dB
Dimensions	346x176x74mm
Code	ADS528

**ACCENTO 6 1/2" 3-WAY 8 OHM RECTANGLE CEILING / IN-WALL**

Exceptional sound reproduction delivered from 3-Way System for full spectrum audio experience. Classic Flange Style. 25mm Dynamic Silk Dome Neodymium Tweeter. 1x 5 1/4" Mid-Range. 1x 6 1/2" Kevlar Woofer. Perfectly matched crossover using high quality components to maintain signal clarity and definition with adjustable tweeter brightness control on front. Ideal for home theatre applications for use as front stage Left / Centre / Right using an In-Wall configuration. Also suits high end multi-room audio applications.

Input	8 Ohm
Pmax	160W
Prms	80W
Freq.	50Hz - 20KHz
Sens.	89 +/- 2 dB
Dimensions	330x180x93mm
Code	ADS658



**ACCENTO 8 OHM / 100V SQUARE CEILING / IN-WALL**

Modern Square frame Ceiling / In-Wall speaker will suit interiors where conventional round is not of choice. 8 Ohm Hi-Fi series featuring two way coaxial design, high performance Kevlar woofer, 18mm Silk Dome Tweeter matched together using a high quality cross-over with adjustable tweeter brightness. 100V PA series utilise a dual cone speaker driver. Available in multiple sizes and inputs.



**8 OHM HI-FI - 2 WAY**

Size	6½"	8"
Input	8 Ohm	8 Ohm
Pmax	100W	120W
Prms	50W	60W
Freq.	60Hz - 20KHz	55Hz - 20KHz
Sens.	88 +/- 2 dB	89 +/- 2 dB
Dimensions	239.5x239.5x75mm	255x255x100mm
Mount	Swivel Tabs	Metal Bracket / Frame
Code	ADS680	ADS860



**100V PA - DUAL CONE**

Size	8"
Input	100V
Taps	6W/3W/1.5W
Pmax	40W
Prms	20W
Freq.	90Hz - 20KHz
Sens.	90 +/- 2 dB
Dimensions	255x255x82mm
Mount	Metal Bracket / Frame
Code	ADS800



**ACCENTO COMPACT CUBE SPEAKER - 8 OHM / 100V**

Accento cube speakers are ultra compact with a stylish design that will fit into any decor seamlessly and provide high performance sound reproduction. Two different models available depending on input required, 8 Ohm Hi-Fi or 100V PA. Available in two colours White or Black. Includes adjustable ball joint mounting bracket to position for best audio experience and seismic cable for safety. Cube size is 87x87x112mm.

**8 OHM HI-FI**

Colour	White	Black
Input	8 Ohm	8 Ohm
Pmax	20W	20W
Prms	10W	10W
Freq.	130Hz - 20KHz	130Hz - 20KHz
Sens.	80 +/- 2 dB	80 +/- 2 dB
Code	ADS320WH	ADS320BK



**100V PA**

Colour	White	Black
Input	100V	100V
Taps	1.5W/3W/6W	1.5W/3W/6W
Pmax	20W	20W
Prms	10W	10W
Freq.	130Hz - 20KHz	130Hz - 20KHz
Sens.	80 +/- 2 dB	80 +/- 2 dB
Code	ADS950WH	ADS950BK



SUPPLEMENT - NEW PRODUCTS

# FRACARRO

## F CONNECTOR TERMINATED LOG PERIODICS LP345MF - 15 ELEMENTS

The ultra compact LP345MF comes with similar performance to the LP345F but in a smaller size. With 8.5dB Gain on VHF, and 9.5dB Gain on UHF, it is ideal for metro areas all around Australia.

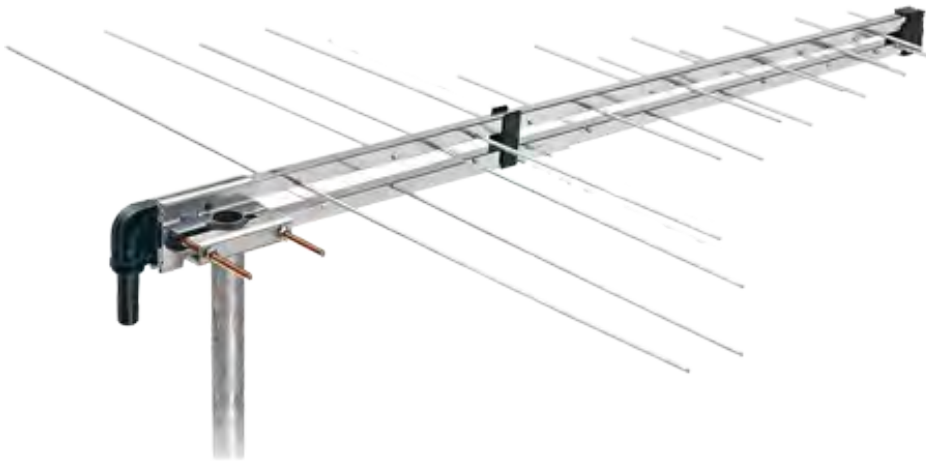

<b>Channels:</b>	VHF: 6–12 b3, UHF: 28–69 b4&5
<b>Gain:</b>	VHF: 8.5dB, UHF: 9.5dB
<b>F/B Ratio:</b>	VHF: 22dB, UHF: 30dB
<b>Boom length:</b>	770 mm

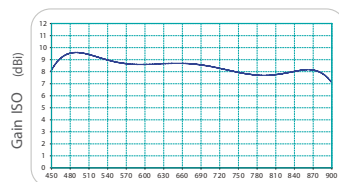

UHF

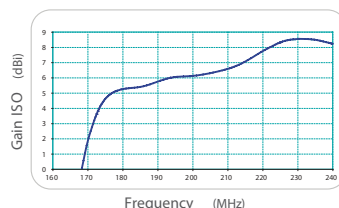
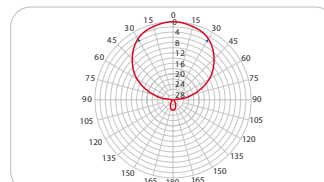

VHF

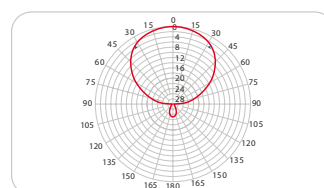

# LP345M-F



**IP65 LED FLOOD LIGHT LAMP**

**HIGHLY ENERGY EFFICIENT**

IP65 highly energy efficient LED flood light. Ultra long life EPISTAR chipset. A great replacement for halogen lamps. Alluminium alloy material with mounting assembly. Special design aluminium reflector improves light uniformity and luminous flux. Safe to use for indoor or outdoor applications, can be positioned at any angle. Suitable for a wide range of applications. 150° beam angle. 240Vac (85 - 260Vac) input voltage.



Energy saver

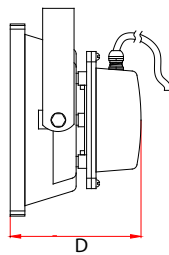
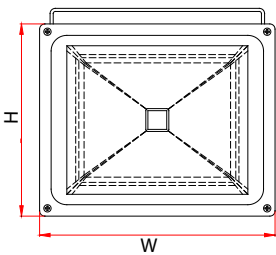

Watt	Colour	Colour Temp	Lumens	Weight	Size	Replaces	Code
10W	Warm White	2900 - 3200K	500	500g	86x114x90mm	40W Halogen	LED2401-1030
10W	Cool White	6000 - 7000K	600	500g	86x114x90mm	40W Halogen	LED2401-1070
20W	Warm White	2900 - 3200K	1300	1000g	140x180x100mm	100W Halogen	LED2401-2030
20W	Cool White	6000 - 7000K	1600	1000g	140x180x100mm	100W Halogen	LED2401-2070
30W	Warm White	2900 - 3200K	2100	2000g	185x225x125mm	150W Halogen	LED2401-3030
30W	Cool White	6000 - 7000K	2400	2000g	185x225x125mm	150W Halogen	LED2401-3070
50W	Warm White	2900 - 3200K	3700	3000g	235x285x145mm	250W Halogen	LED2401-5030
50W	Cool White	6000 - 7000K	4000	3000g	235x285x145mm	250W Halogen	LED2401-5070



